

S

T

I

L

L

S

**S**

**T**

**I**

**L**

**L**

**S**

Indice  
Index

<b>Lavabi</b>	02
Washbasins	
<b>Vasche, Sanitari, Docce</b>	58
Bathtubs, Sanitary Fixtures, Shower Boxes	
<b>Rubinetti</b>	94
Taps	
<b>Accessori</b>	194
Accessories	
<b>Complementi, Specchi, Lampade</b>	240
Complementary Items, Mirrors, Lamps	
<b>Disegni Tecnici</b>	290
Technical Drawings	



Lavabi  
Washbasins

<b>A45</b> Victor Vasilev 2013	04
<b>A45 Compact</b> Victor Vasilev 2016	06
<b>A45 Stone</b> Victor Vasilev 2016	08
<b>B15</b> Norbert Wangen 2008	10
<b>B15C</b> Norbert Wangen 2008	12
<b>Canale</b> Piero Lissoni 2006	14
<b>Cathino</b> Piero Lissoni 2011	15
<b>Duec</b> Victor Vasilev 2014	16
<b>Emisfero Stone</b> CRS Boffi 2018	18
<b>Fisher Island</b> Piero Lissoni 2016	20
<b>Floe</b> Keiji Takeuchi 2018	22
<b>Floe Stone</b> Keiji Takeuchi 2018	24
<b>Garden</b> Piero Lissoni 2016	26
<b>Gobi</b> Marcel Wanders 2001	30
<b>Iceland</b> Piero Lissoni 2010	31
<b>I Fiumi: Adige</b> Claudio Silvestrin 1999	32
<b>I Fiumi: Adda</b> Claudio Silvestrin 1999	34
<b>I Fiumi: Piave</b> Claudio Silvestrin 1999	35
<b>Kupa</b> Victor Vasilev 2015	36
<b>L10</b> Norbert Wangen 2007	38
<b>L14</b> Norbert Wangen 2018	40
<b>L18</b> Norbert Wangen 2018	41
<b>Lotus</b> Naoto Fukasawa 2014	42
<b>Phc</b> Piero Lissoni 2001	44
<b>Ph Stone</b> Piero Lissoni 2017	46
<b>Phw</b> Piero Lissoni 2001	48
<b>Pietra</b> CRS Boffi 2013	50
<b>Quadtwo</b> Jeffrey Bennett 2012	52
<b>Sabbia</b> Naoto Fukasawa 2008	54
<b>Universal</b> Piero Lissoni 2003	55

**A45**  
V. Vasilev

**A45**

/ Lavabo d'appoggio  
o sospeso in Cristalplant®  
con pianetto copriscarico  
opzionale in Cristalplant®  
o legno massello.

/ Top-mounted or  
suspended washbasin in  
Cristalplant®, with optional  
drain-hole covering shelf  
in Cristalplant® or solid  
wood.

/ Lavabo d'appui ou  
suspendu en Cristalplant®  
blanc, avec petit plan  
couvre-écoulement en  
option, en Cristalplant®  
ou bois massif.

/ Aufgebautes oder  
wandbefestigtes  
Waschbecken aus  
Cristalplant® weiß, mit  
Auslauf-Abdeckplatte,  
optional, aus Cristalplant®  
oder Massivholz.

/ Lavabo apoyado o sus-  
pendido en Cristalplant®,  
con tablero cubre desagüe  
opcional en Cristalplant®  
o madera maciza.





**A45 Compact**  
/ Lavabo d'appoggio o  
sospeso in Cristalplant®.  
/ Top-mounted or  
suspended washbasin  
in Cristalplant®.  
/ Lavabo d'appui ou  
suspendu en  
Cristalplant®.  
/ Aufgebautes oder  
wandbefestigtes  
Waschbecken aus  
Cristalplant®.  
/ Lavabo apoyado  
o suspendido en  
Cristalplant.

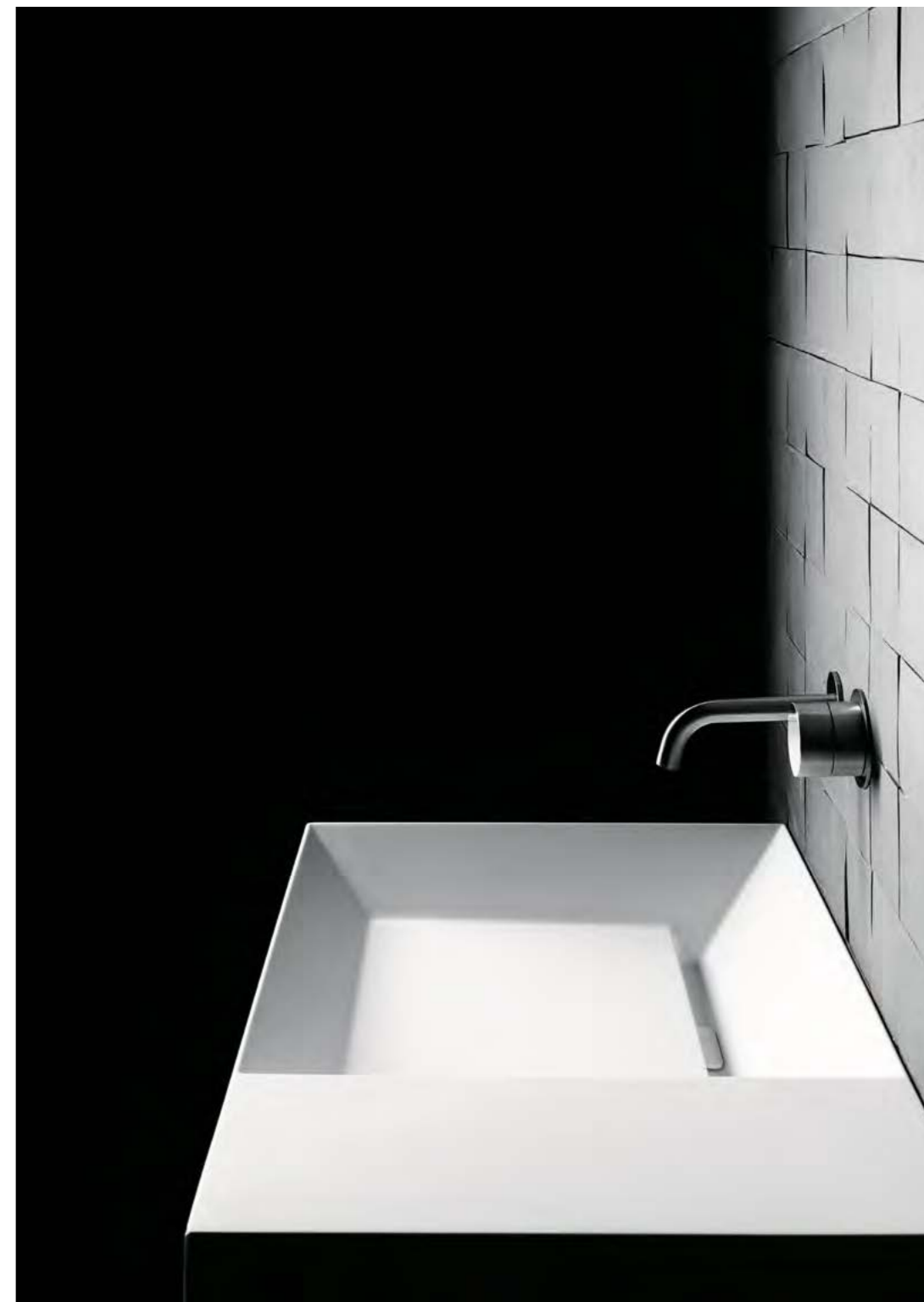

**A45 Stone**  
V. Vasilev

**A45 Stone**

/ Lavabo d'appoggio  
o sospeso in marmo  
bianco di Carrara.

/ Top-mounted or  
suspended washbasin  
in white Carrara marble.

/ Lavabo d'appui ou  
suspendu en marbre  
blanc Carrara.

/ Aufgebautes oder wand  
befestigtes Waschbecken  
in Carrara-Marmor weiß.

/ Lavabo apoyado o  
suspendido de mármol  
blanco Carrara.



**B15**  
N.Wangen

**B15**

/ Base monoblocco  
portalavabo con piano  
e spalla in marmo,  
con vasca lavamani  
integrata nel piano.

/ Monoblock unit for  
washbasin with top  
and side panel in marble,  
with basin integrated  
in the top.

/ Base porte-lavabo avec  
plan lavabo et panneau  
vertical en marbre.

/ Blockunterschrank  
für Waschbecken mit  
Waschtischplatte und  
Seitenteil aus Marmor,  
mit Handwaschbecken  
integriertem in  
Waschtischplatte.

/ Mueble bajo para lavabo  
con costado y frentes  
cajón en acabado.  
Encimera lavabo y panel  
trasero de mármol.







**B15C**

/ Base monoblocco portalavabo con piano e spalla in Cristalplant®, con vasca lavamani integrata nel piano,  
/ Monoblock unit for washbasin with top and side panel in Cristalplant®, with basin integrated in the top.  
/ Base porte-lavabo avec plan lavabo et panneau vertical en Cristalplant®.  
/ Blockunterschrank für Waschbecken mit Waschtischplatte und Seitenteil aus Cristalplant®, mit Handwaschbecken integriertem in Waschtischplatte.  
/ Mueble bajo para lavabo con costado y frentes cajón en acabado. Encimera lavabo y panel trasero de Cristalplant®.





**Canale**  
Lavabo da appoggio o  
sospeso  
monoblocco in  
Cristalplant® bianco.  
/ Washbasin for counter  
top mounting or suspen-  
ded monoblock washba-  
sin  
in white Cristalplant®.  
/ Lavabo en appui ou  
suspendu  
en un seul bloc en  
Cristalplant®  
blanc.  
/ Aufsatz-Waschbecken  
oder Blockwaschbecken  
aus Cristalplant® weiß.  
/ Lavabo sobre encimera  
o suspendido monoblo-  
que  
en Cristalplant® blanco.

**Cathino**  
/ Lavabo da appoggio  
in Ceramilux® bianco.  
/ Washbasin for counter  
top mounting in white  
Ceramilux®.  
/ Lavabo sur plan en  
Ceramilux® blanc.  
/ Aufsatz-Waschbecken  
aus Ceramilux® weiß.  
/ Lavabo sobre encimera  
en Ceramilux® blanco.





**Duec**

/ Sistema modulare di contenitori a giorno in Corian® bianco o in PaperStone® nero ed elementi lavabo in Corian® bianco.  
/ Modular system composed of open-faced units in white Corian® or in black PaperStone® and washbasin elements in white Corian®.  
/ Système modulaire d'éléments ouverts en Corian® blanc ou en PaperStone® noir et éléments lavabo en Corian® blanc.  
/ Modulares System mit offenen Elementen aus Corian® weiß oder aus PaperStone® schwarz und Waschbeckenelementen aus Corian® weiß.  
/ Sistema modular de muebles contenedores abierto en Corian® blanco o PaperStone® negro y elementos lavabo en Corian® blanco.



**Emisfero Stone**  
CRS Boffi

**Emisfero Stone**

/ Lavabo da incasso  
in massello marmo –  
granito – pietra.  
/ Built-in washbasin  
in solid marble –  
granite – stone.  
/ Lavabo à encastrer  
en massif de marbre –  
granite – pierre.  
/ Einbauwaschbecken  
aus massivem Marmor –  
Granit – Stein.  
/ Lavabo para  
empotrado en mármol –  
granito – piedra.

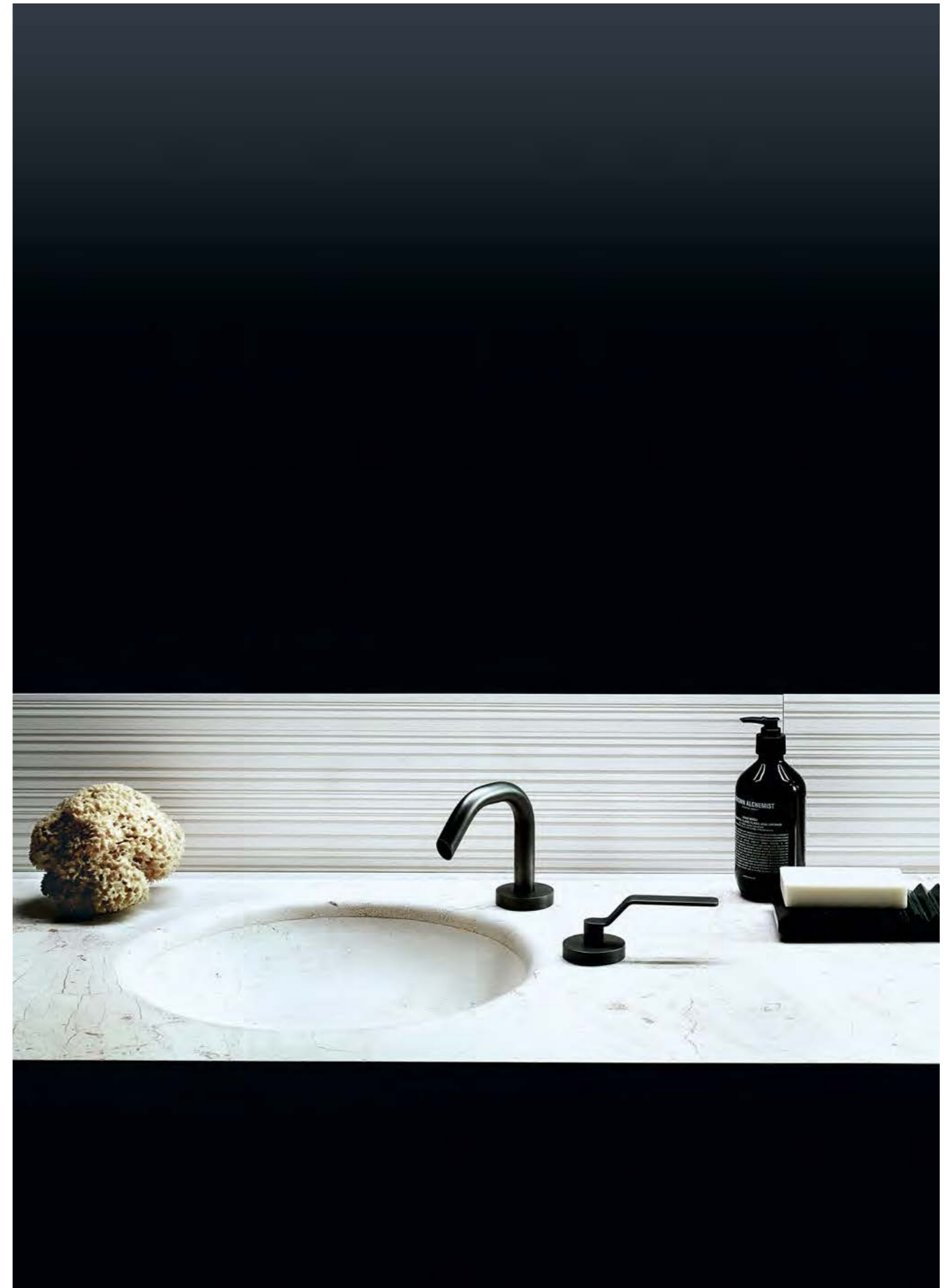



**Fisher Island**  
P. Lissoni + CRS Boffi

**Fisher Island**  
/ Lavabo da piano  
in Cristalplant®,  
tutto bianco o bianco  
con rivestimento esterno  
in vernice grigio antracite.  
/ Washbasin for counter  
top mounting, in  
Cristalplant®, totally white  
or white + coatings made  
of anthracite grey paint.  
/ Lavabo pour plan,  
en Cristalplant®, tout  
blanc ou blanc + revête-  
ment externe avec  
peinture gris anthracite.  
/ Waschbecken für  
Waschtischplatten, aus  
Cristalplant®, vollständig  
weiß oder weiß + Außenla-  
ckierung anthrazitgrau.  
/ Lavabo apoyado en  
Cristalplant®, todo blanco  
o blanco + revestimiento  
exterior con pintura gris  
antracita.

**Floe**  
K. Takeuchi

**Floe**  
/ Lavabo da incasso  
singolo o doppio  
in Cristalplant®  
con piano integrato.  
/ Built-in single or double  
washbasin in Cristalplant®  
with integrated top.  
/ Lavabo single ou  
double à encastrer  
en Cristalplant® avec  
plan intégré.  
/ Einzel-oder Doppel  
Einbauwaschbecken  
aus Cristalplant® mit  
integrierter Platte.  
/ Lavabo singolo o  
doble para empotrado  
de Cristalplant® con  
encimera empotrada.



**Floe Stone**  
K. Takeuchi

**Floe Stone**

/ Lavabo da incasso  
singolo o doppio in  
marmo granito – pietra  
con piano integrato.

/ Built-in single or double  
washbasin in marble –  
granite stone with  
integrated top.

/ Lavabo single ou  
double à encastrer  
en marbre – granite  
pierre avec plan intégré.

/ Einzel-oder Doppel  
Einbauwaschbecken  
aus Marmor – Granit  
Stein mit integrierter  
Platte.

/ Lavabo singolo o  
doble para empotrado  
de mármol – granito  
piedra con encimera  
empotrada.



**Garden**  
P. Lissoni

**Garden**

/ Lavabo soprapiano in lamiera di acciaio finitura grigio PVD. Pianetto copri-scarico interno: pietra - marmo - granito - Corian® bianco.

/ Top-mounted washbasin in stainless steel sheet, grey PVD finish. Drain-hole covering shelf: stone - marble - granite - white Corian.

/ Lavabo sur plan en tôle acier inox finition gris PVD. Petit plan couvre-écoulement interne: pierre - marbre - granite - Corian® blanc.

/ Aufsatz-Waschbecken in Edelstahlblech, Ausführung grau PVD. Abdeckplatte für Ablauf: Stein - Marmor - Granit - Corian® weiß.

/ Lavabo sobre encimera en chapa de acero inoxidable acabado gris PVD, sin rebosadero. Tablero cubre-desagüe: piedra - mármol - granito - Corian® blanco.







**Gobi**  
M. Wanders

**Gobi**

/ Lavabo da piano in Cristalplant®, tutto bianco o bianco con rivestimento esterno in vernice grigio antracite.

/ Washbasin for counter top mounting, in Cristalplant®, totally white or white + coating made of anthracite grey paint.

/ Lavabo pour plan, en Cristalplant®, tout blanc ou blanc + revêtement externe avec peinture gris anthracite.

/ Waschbecken für Waschtischplatten, aus Cristalplant®, vollständig weiß oder weiß + Außenlackierung anthrazitgrau.

/ Lavabo apoyado en Cristalplant®, todo blanco o blanco + revestimiento exterior con pintura gris antracita.



**Iceland**  
P. Lissoni

**Iceland**

/ Lavabo da piano in Cristalplant®, tutto bianco o bianco con rivestimento esterno in vernice grigio antracite.

/ Washbasin for counter top mounting, in Cristalplant®, totally white or white + coating made of anthracite grey paint.

/ Lavabo pour plan, en Cristalplant®, tout blanc ou blanc + revêtement externe avec peinture gris anthracite.

/ Waschbecken für Waschtischplatten, aus Cristalplant®, vollständig weiß oder weiß + Außenlackierung anthrazitgrau.

/ Lavabo apoyado en Cristalplant®, todo blanco o blanco + revestimiento exterior con pintura gris antracita.



**I Fiumi: Adige**  
C. Silvestrin

**I Fiumi: Adige**  
/ Lavabo realizzato  
in massello di pietra  
naturale.  
/ Washbasin in solid  
natural stone.  
/ Lavabo en pierre  
naturelle.  
/ Waschbecken aus  
massivem Natur-Stein.  
/ Lavabo de piedra  
maciza.



**I Fiumi: Adda**  
C. Silvestrin

**I Fiumi: Adda**  
/ Lavabo realizzato  
Corian® bianco.  
/ Washbasin in white  
Corian®.  
/ Lavabo en Corian®  
blanc.  
/ Aufgebautes  
Waschbecken  
aus Corian®.  
/ Lavabo apoyado  
de Corian®.



**I Fiumi: Piave**  
C. Silvestrin

**I Fiumi: Piave**  
/ Lavabo realizzato  
in massello di pietra  
naturale.  
/ Washbasin in solid  
natural stone.  
/ Lavabo en pierre  
naturelle.  
/ Waschbecken aus  
massivem Natur-Stein.  
/ Lavabo de piedra  
maciza.



**Kupa**  
V. Vasilev

**Kupa**  
/ Lavabo filopiano  
stampato in Cristalplant®.  
/ Moulded flush-mounted  
washbasin in Cristalplant®.  
/ Lavabo moulé en  
encastrement affleurant,  
en Cristalplant®.  
/ Flächenbündiges,  
formgepresstes  
Einbau-Waschbecken  
aus Cristalplant®.  
/ Lavabo empotrado  
a ras de la encimera,  
moldeado de Cristalplant®.



**L10**  
N. Wangen

**L10**

/ Lavabo in massello di marmo, in finitura satinata o levigata opaca, utilizzabile in appoggio su piano o a parete con staffa.

/ Washbasin in solid marble, satin or matt honed finish.

The basin can be used both supported on a cabinet and free standing, fixed to the wall with brackets.

/ Lavabo en marbre massif, en finition satinée ou poncée mate. A' utiliser à poser sur plan ou au fixer au mur avec étrier.

/ Waschbecken aus Marmor, in Ausführung satiniert oder matt geschliffen. Zum Aufbauen oder zur Wandbefestigung Trägerstruktur.

/ Lavabo en mármol macizo, acabado satinado o pulido mate. También suspendido con estructura de soporte.

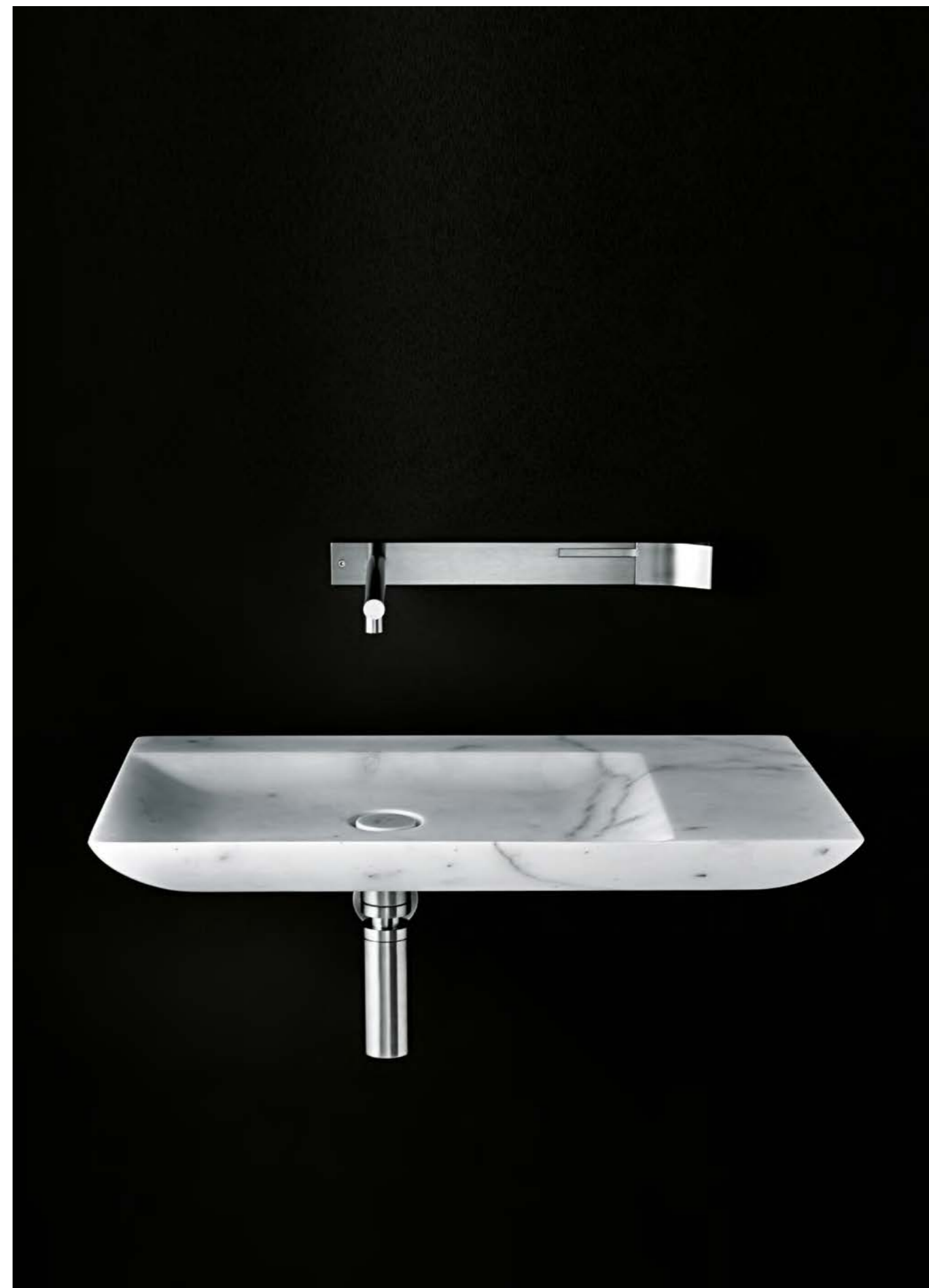

**L14**  
N. Wangen

**L14**  
/ Lavabo da parete  
in massello di marmo  
o pietra.  
/ Wall washbasin in  
solid marble or stone.  
/ Lavabo murale  
en massif de marbre  
ou pierre.  
/ Wand-Waschbecken  
aus massivem Marmor  
oder Stein.  
/ Lavabo de pared  
en mármol o piedra.



**L18**  
N. Wangen

**L18**  
/ Lavabo da parete doppio  
in massello di marmo  
o pietra.  
/ Double wall washbasin  
in solid marble or stone.  
/ Lavabo murale double  
en massif de marbre  
ou pierre.  
/ Wand Doppelwasch-  
becken aus massivem  
Marmor oder Stein.  
/ Lavabo de pared doble  
en mármol o piedra.





**Lotus**  
/ Lavabo d'appoggio o  
sospeso in Cristalplant®  
bianco.  
/ Top-mounted or  
suspended washbasin  
in white Cristalplant®.  
/ Lavabo d'appui  
ou suspendu en  
Cristalplant® blanc.  
/ Aufgebautes oder  
wandbefestigtes  
Waschbecken aus  
Cristalplant® weiß.  
/ Lavabo apoyado  
o suspendido en  
Cristalplant® blanco.





**Phc**

/ Lavabo a colonna in Corian® bianco o in Cristalplant® tutto bianco o bianco con rivestimento esterno in vernice grigio antracite.

/ Free-standing washbasin in white Corian® or in white Cristalplant® or white + coating made of anthracite grey paint.

/ Lavabo à colonne en Corian® blanc ou en Cristalplant® blanc mat ou blanc + revêtement externe avec peinture gris anthracite.

/ Waschbecken in Säulenform aus Corian® Weiss aus Cristalplant® mattweiß oder weiß + Außenlackierung anthrazitgrau.

/ Lavabo de columna de Corian® o en Cristalplant® blanco mate o blanco + revestimiento exterior con pintura gris antracita.



**Ph Stone**  
P. Lissoni

**Ph Stone**

Lavabo a colonna  
in marmo o pietra.  
A parete o a centro  
stanza.  
/ Free-standing  
washbasin in marble  
or stone. Wall-mounted  
or freestanding version.  
/ Lavabo à colonne  
en marbre ou pierre.  
Muralou au centre  
de la pièce.  
/ Waschbecken in  
Säulenform aus  
Marmor oder Stein.  
Wandbefestigt  
oder freistehend.  
/ Lavabo de columna  
de mármol o piedra.  
De pared o en el  
centro del cuarto.



**Phw**  
P. Lissoni

**Phw**  
/ Lavabo in Corian®  
bianco.  
/ Washbasin in white  
Corian®.  
/ Lavabo en Corian®  
blanc.  
/ Waschbecken aus  
Corian® weiss.  
/ Lavabo de Corian®.





**Pietra**  
/ Lavabo sottopiano  
in pietra, marmo, granito  
o compositi.  
/ Under-mounted washbasin  
in stone, marble, granite  
or composites.  
/ Lavabo sous plan en pier-  
re, marbre, granite,  
composites.  
/ Unterbau-Waschbecken  
aus Stein, Marmor, Granit,  
Agglomerat.  
/ Lavabo bajo encimera  
de piedra, mármol, granito,  
compuestos.





**Quadtwo**

/ Base portlavabo  
in Silcover, piano  
in Cristalplant® bianco  
e lavabo integrato  
Universal.  
/ Base unit for washbasin  
in Silcover, top in white  
Cristalplant® and integrated  
washbasin Universal.  
/ Base porte-lavabo  
en Silcover, plan  
en Cristalplant® blanc  
et lavabo intégré Universal.  
/ Unterschrank für  
Waschbecken aus Silcover,  
Waschtischplatte  
aus Cristalplant® weiß,  
integriertes Waschbecken  
Universal.  
/ Mueble bajo para lavabo  
en Silcover, encimera  
en Cristalplant® blanco  
y lavabo integrado Universal.



**Sabbia**  
N. Fukasawa

**Sabbia**  
/ Lavabo in Cristalplant®  
bianco.  
/ Washbasin in white  
Cristalplant®.  
/ Lavabo en Cristalplant®  
blanc.  
/ Waschbecken aus  
Cristalplant® weiss.  
/ Lavabo de Cristalplant®.



**Sabbia**  
N. Fukasawa



**Universal**  
P. Lissoni

**Universal**  
/ Lavabo sottopiano  
in Cristalplant®.  
/ Under-mounted  
washbasin in Cristalplant®.  
/ Lavabo sous-plan  
en Cristalplant®.  
/ Untergebautes  
Waschbecken aus  
Cristalplant®.  
/ Lavabo de Cristalplant®.





Vasche, Sanitari, Docce  
Bathtubs, Sanitary Fixtures, Shower Boxes

<b>Ark N.</b> Fukasawa 2015	60
<b>Faroe P.</b> Lissoni 2018	62
<b>Fisher Island P.</b> Lissoni + CRS Boffi 2015	64
<b>Fisher Island Stone P.</b> Lissoni + CRS Boffi 2017	66
<b>Iceland P.</b> Lissoni 2008	68
<b>I Fiumi: Po C.</b> Silvestrin 1999	70
<b>I Fiumi: Tevere C.</b> Silvestrin 1999	72
<b>Round Fisher P.</b> Lissoni 2019	74
<b>Sabbia N.</b> Fukasawa 2008	76
<b>Swim C P.</b> Lissoni 2003	78
<b>Terra N.</b> Fukasawa 2006	79
<b>Sanitari XY P.</b> Lissoni 2012	80
<b>Sanitari Galassia R.</b> Adolini	82
<b>Sliding P.</b> Lissoni + CRS Boffi 2015	86
<b>Tape M.</b> Armani 2012	90





**Ark**

/ Vasca monoblocco in Cristalplant®, tutto bianco o bianco con rivestimento esterno in vernice grigio antracite.

/ Mono-block bathtub in Cristalplant®, totally white or white + coating made of anthracite grey paint.

/ Baignoire Monobloc en Cristalplant®, tout blanc ou blanc + revêtement externe avec peinture gris anthracite.

/ Blockbadewanne aus Cristalplant®, vollständig weiß oder weiß + Außenlackierung anthrazitgrau.

/ Bañera monobloque en Cristalplant®, todo blanco o blanco + revestimiento exterior con pintura gris antracita.





**Faroe**  
/ Vasca monoblocco in  
Cristalplant® bianco o  
bianco con rivestimento  
esterno in vernice grigio  
antracite.  
/ Monobloc bathtub  
in Cristalplant® totally  
white or white + coating  
made of anthracite grey  
paint.  
/ Baignoire monobloc  
en Cristalplant® blanc  
ou blanc + revêtement  
externe avec peinture  
gris anthracite.  
/ Blockbadewanne aus  
Cristalplant® weiß oder  
weiß + Außenlackierung  
anthrazitgrau.  
/ Bañera monobloque in  
Cristalplant® blanco o  
blanco + revestimiento  
exterior con pintura gris  
antracita.



**Fisher Island**  
/ Vasca monoblocco in Ceramilux® bianco opaco o bianco con rivestimento esterno in vernice grigio antracite.  
/ Monobloc bathtub in white Ceramilux® or white + coating made of anthracite grey paint.  
/ Baignoire en un seul bloc en Ceramilux® blanc mat ou blanc + revêtement externe avec peinture gris anthracite.  
/ Blockbadewanne aus Ceramilux® mattweiß oder weiß + Außenlackierung anthrazitgrau.  
/ Bañera monobloque en Ceramilux® blanco mate o blanco + revestimiento exterior con pintura gris antracita.



**Fisher Island Stone**  
P. Lissoni + CRS Boffi

**Fisher Island Stone**  
/ Vasca monoblocco in  
massello marmo o pietra.  
/ Monobloc bathtub  
in solid marble or stone.  
/ Baignoire en un  
seul bloc en massif  
de marbre ou pierre.  
/ Blockbadewanne  
aus massivem  
Marmor oder Stein.  
/ Bañera monobloque  
en mármol ou piedra.



**Iceland**  
P. Lissoni

**Iceland**

/ Vasca monoblocco  
in Cristalplant®, tutto  
bianco o bianco con  
rivestimento esterno  
in vernice grigio antracite.

/ Mono-block bathtub  
in Cristalplant®, totally  
white or white + coating  
made of anthracite  
grey paint.

/ Baignoire monobloc  
en Cristalplant®, tout blanc  
ou blanc + revêtement  
externe avec peinture  
gris anthracite.

/ Blockbadewanne  
aus Cristalplant®,  
vollständig weiß oder  
weiß + Außenlackierung  
anthrazitgrau.

/ Bañera monobloque  
en Cristalplant®, todo  
blanco o blanco +  
revestimiento exterior  
con pintura gris antracita.



**I Fiumi: Po**  
C. Silvestrin

**I Fiumi: Po**

/ Vasca realizzata  
in massello di pietra  
naturale o Corian®  
termoformato.  
/ Bathtub in solid natural  
stone or thermoformed  
Corian®.  
/ Baignoire en pierre  
naturelle ou Corian®  
thermoformé.  
/ Badewanne aus  
massivem Natur-Stein  
oder Corian®  
thermoformiert.  
/ Bañera monobloque  
de piedra natural o en  
Corian® termoformado.





**I Fiumi: Tevere**  
/ Vasca realizzata  
in Corian® bianco  
termoformato,  
sezione rotonda.  
/ Bathtub in white  
thermoformed Corian®,  
round version.  
/ Baignoire en Corian®  
blanc thermoformé,  
en section circulaire.  
/ Badewanne aus  
weißem Corian®  
thermoformiert,  
runde Version.  
/ Bañera monobloque  
en Corian® blanco  
termoformado.



**Round Fisher**  
/ Vasca monoblocco  
realizzata in Corian®  
colore bianco semi-opaco  
o Grey semi-lucido.  
/ Monobloc bathtub in  
Corian® semi-matt white  
or semi-glossy Grey.  
/ Baignoire en un seul  
bloc en Corian® blanc  
fini semi-mat ou Grey  
semi-brillant.  
/ Blockbadewanne aus  
Corian® weiß semi-matt  
oder Grey semi-glänzend.  
/ Bañera monobloque  
en Corian® blanco  
semi-mate o Grey  
semi-brillante.



**Sabbia**  
N. Fukasawa

**Sabbia**  
/ Vasca monoblocco  
in Cristalplant®.  
/ Mono-block bathtub  
in Cristalplant®.  
/ Baignoire monobloc  
en Cristalplant®.  
/ Blockbadewanne  
aus Cristalplant®.  
/ Bañera monobloque  
en Cristalplant®.



**Swim C**  
P. Lissoni

**Swim C**

/ Vasca con doppio schienale interamente realizzata in Cristalplant® bianco.  
/ Bathtubs in white Cristalplant® with double backrest slope.  
/ Baignoire en Cristalplant® avec double appuie-dos.  
/ Badewannen, mit zwei Innenschrägen, aus Cristalplant® weiß.  
/ Bañera en Cristalplant® con doble respaldo.



**Terra**  
N. Fukasawa

**Terra**

/ Vasca monoblocco in Cristalplant®, erogazione dal bordo vasca.  
/ Monobloc bathtub in Cristalplant®, water supply from bathtub edge.  
/ Baignoire monobloc en Cristalplant®, débit du plan baignoire.  
/ Blockbadewanne aus Cristalplant®, mit Wasserzulauf an Wannenrand.  
/ Bañera monobloque en Cristalplant® blanco, erogación desde borde bañera.





**Sanitari XY**  
/ Sanitari XY in ceramica  
bianca lucida o opaca.  
/ Sanitary fixtures XY  
in white polished  
or matt ceramic.  
/ Sanitaires XY céramique  
blanc brillant ou mat.  
/ Sanitäranlagen XY  
aus Keramik weiß  
glänzend oder matt.  
/ Sanitarios XY  
en cerámica blanco  
brillante o mate.



**Sanitari Galassia**  
R. Adolini

**Sanitari Galassia**

/ Sanitari Galassia,  
serie XES e SAO2 in  
ceramica bianca lucida.

/ Sanitary fixtures  
Galassia - Model XES  
and SAO2 - in white  
polished ceramic.

/ Sanitaires Galassia -  
Série XES et SAO2 -  
Céramique blanche polie.

/ Sanitäranlagen Galassia -  
XES und SAO2 - aus  
Keramik weiß glänzend.

/ Sanitarios Galassia  
XES y SAO2 en cerámica  
blanco brillante.





**Sliding**  
P. Lissoni + CRS Boffi

**Sliding**

/ Box doccia in vetro temperato. Profili e maniglia in alluminio anodizzato nero o inox.

/ Shower box in tempered glass. Profiles and handle in black anodised aluminium or stainless steel.

/ Cabine de douche en verre trempé.

Profils et poignée en aluminium anodisé disponible noir ou inox.

/ Duschkabine aus ehärtetem Glas. Profile und Griff aus eloxiertem Aluminium verfügbar in den Ausführungen schwarz oder Edelstahl.

/ Cabina ducha en vidrio templado. Perfiles y tirador de aluminio anodizado negro o inox.



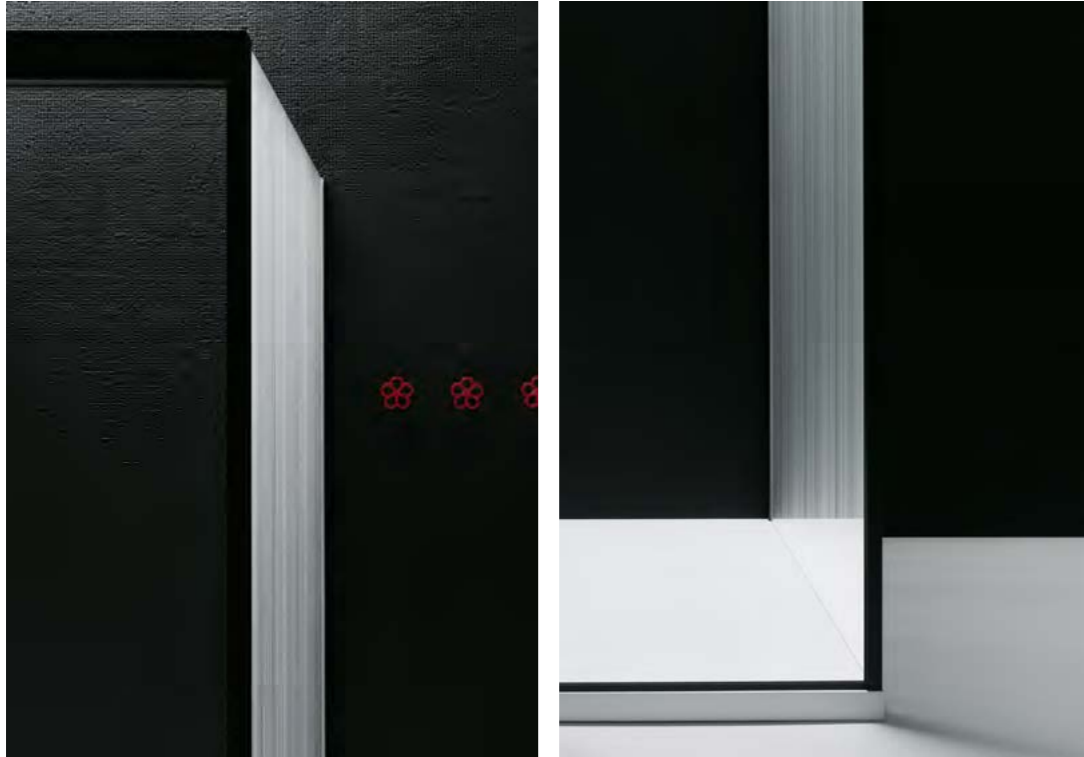

**Tape**  
M. Armani

**Tape**

/ Box doccia in vetro  
extrachiaro trasparente  
temperato con piatto  
doccia in Ceramilux®  
bianco opaco.

/ Shower box in extra  
light transparent tempered  
glass with shower tray  
made of matt white  
Ceramilux®.

/ Cabine de douche en  
verre extraclair transparent  
trempé avec receveurs  
douche réalisé en  
Ceramilux® blanc mat.

/ Duschkabinen aus  
Extrahellem transpa-  
rentem Hartglas mit  
Duschwannen  
aus Ceramilux® mattweiß.

/ Cabina de ducha  
en vidrio extraclaro  
transparente emplado  
con plato de ducha  
realizado en Ceramilux®  
blanco mate.







Rubinetti  
Taps

<b>Cut</b> M. Tessarollo, T. Cerato 2002	96
<b>Eclipse</b> Studiocharlie 2014	104
<b>Garden</b> P. Lissoni 2015	122
<b>Liquid</b> P. Lissoni 2002	130
<b>Minimal</b> G. Gianturco 1996	144
<b>Pipe</b> M. Wanders 2001	160
<b>Uni</b> CRS Boffi 2005	168
<b>W1</b> N. Wangen 2006	174
<b>Wings</b> M. Tessarollo 2009	182
<b>Articoli Universali</b>	192

**Cut**  
M. Tessarollo, T. Cerato

**Cut**

/ Miscelatori in acciaio inox AISI 304, finitura satinata, con cartuccia ceramica progressiva. Portata d'acqua costante e temperatura regolabile.  
/ Mixers in stainless steel AISI 304, satin finish, with progressive ceramic cartridge. Invariable water capacity and adjustable temperature.  
/ Mélangeurs mitigeurs en acier inox AISI 304, finition satinée, avec cartouche en céramique progressive. Portée d'eau constante et température réglable.  
/ Mischer aus Edelstahl AISI 304 satiniert, mit stufenregulierbarer Patrone aus Keramik, gleichbleibender Wasserzulauf und regulierbare Temperatur.  
/ Grifería de acero inoxidable AISI 304 satinado, con cartucho cerámico progresivo. Caudal de agua constante y temperatura ajustable.



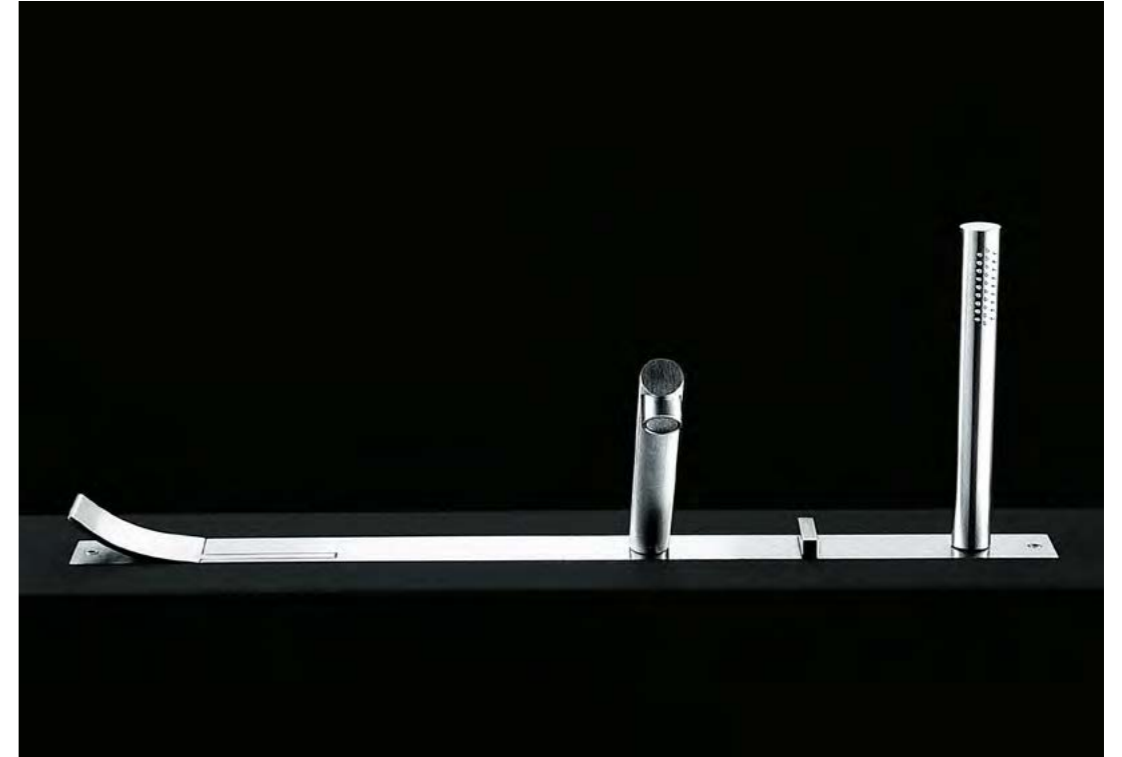
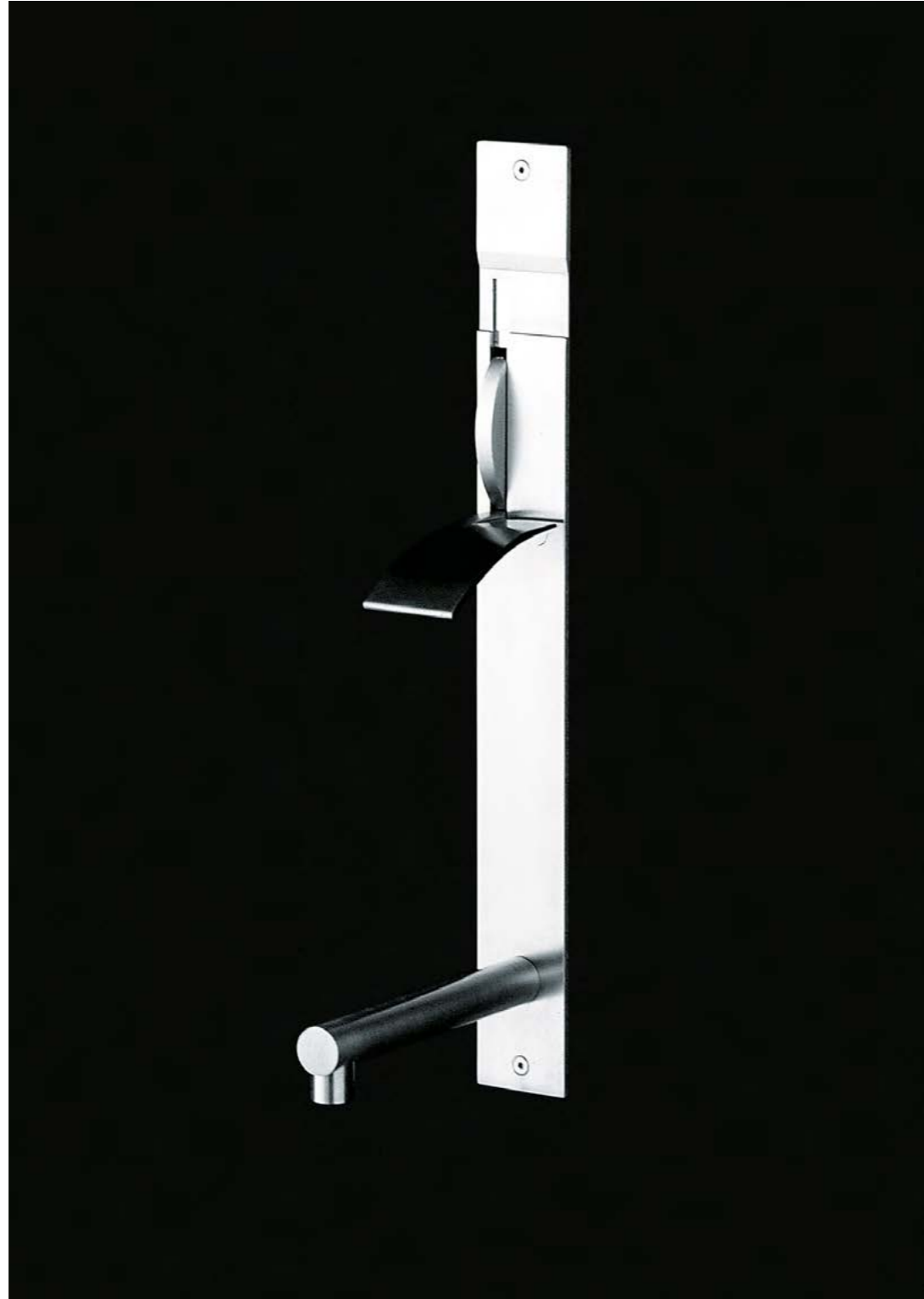



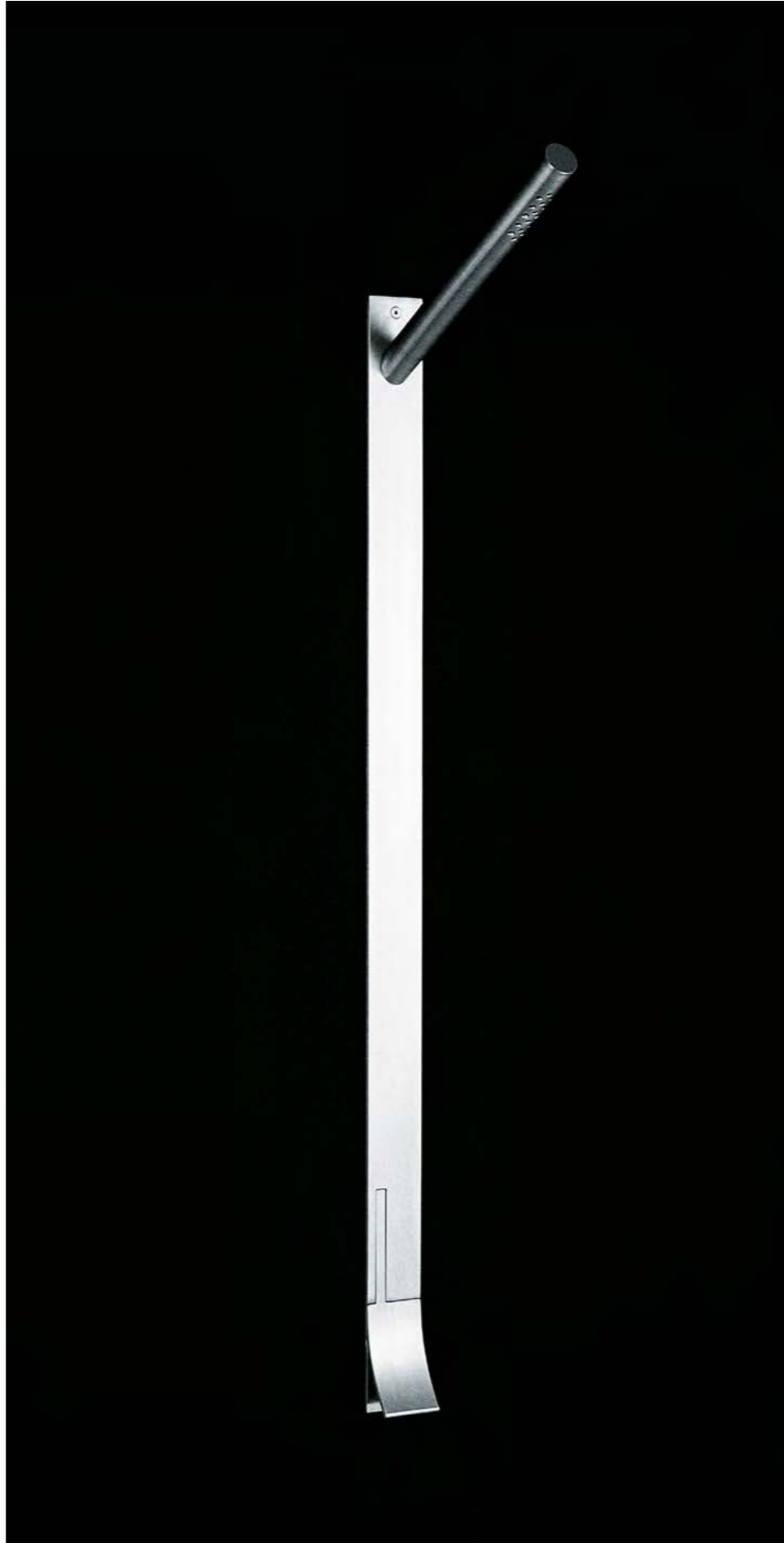

**Eclipse**  
Studiocharlie

**Eclipse**

/ Rubinetteria in acciaio  
inox AISI 304. Finitura  
satinata o grigio PVD.

/ Taps in stainless steel  
AISI 304. Finishes:  
satin or grey PVD.

/ Robinetterie en acier  
inox AISI 304. Finition:  
satinée ou gris PVD.

/ Armaturen aus Edelstahl  
AISI 304. Ausführungen:  
satinieret oder grau PVD.

/ Grifería de acero  
inoxidable AISI 304.

Acabado: satinado  
o gris PVD.





















**Garden**  
P. Lissoni

**Garden**  
/ Rubinetteria in acciaio inox AISI 304 - Finitura grigio PVD.  
/ Taps in AISI 304 stainless steel - Finish: grey PVD.  
/ Robinetterie en acier inox AISI 304 - Finition gris PVD.  
/ Armaturen in Edelstahl AISI 304 - Ausführung grau PVD.  
/ Grifería de acero inoxidable AISI 304 - Acabado gris PVD.











**Liquid**  
P. Lissoni

**Liquid**  
/ Rubinetteria in ottone  
cromato.  
/ Taps in chromium-  
plated brass.  
/ Robinetterie en laiton  
chromé.  
/ Armaturen aus Messing  
verchromt.  
/ Grifería de latón  
cromado.



















\* Disponibile fino ad esaurimento scorte  
Available until stock lasts



**Minimal**  
/ Rubinetteria in acciaio  
inox AISI 304, finitura  
satinata.  
/ Taps in stainless steel  
AISI 304, satinised finish.  
/ Robinetterie en acier  
AISI 304, finition satinée.  
/ Armaturen aus  
Edelstahl  
AISI 304, satiniert.  
/ Grifería de acero  
inoxidable AISI 304,  
satinado.





**Minimal**  
G. Gianturco

\* Disponibile fino ad esaurimento scorte  
Available until stock lasts















**Pipe**  
M. Wanders

**Pipe**  
/ Rubinetteria in acciaio  
inox AISI 304, finitura  
satinata.  
/ Taps in satin stainless  
steel AISI 304.  
/ Robinetterie en acier  
inox satiné AISI 304.  
/ Armaturen aus Edelstahl  
AISI 304 satiniert.  
/ Griferia de acero inoxi-  
dable satinado AISI 304.

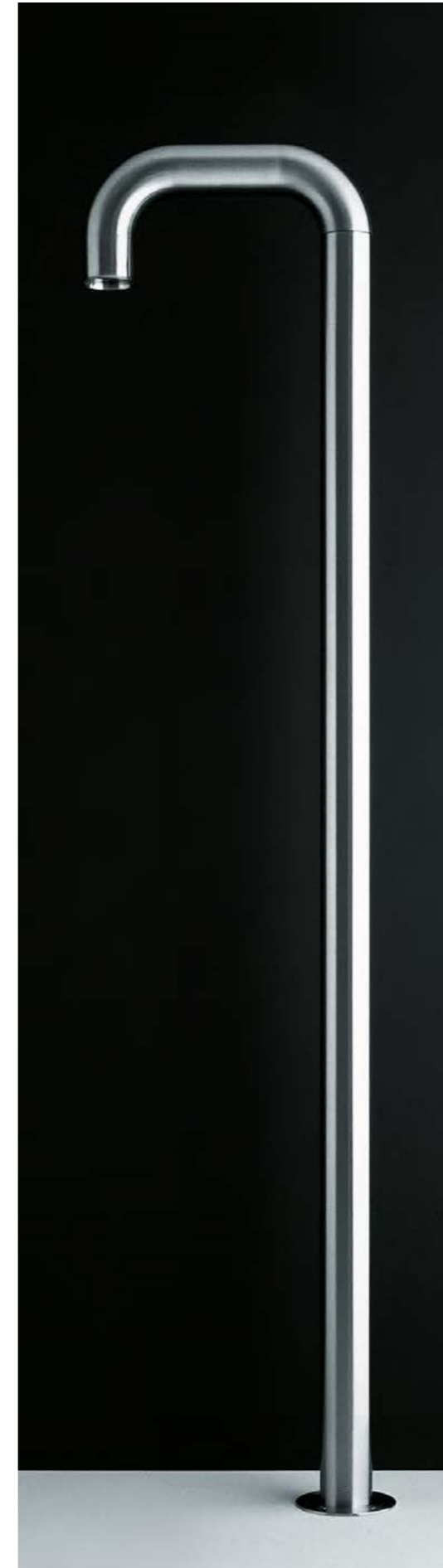





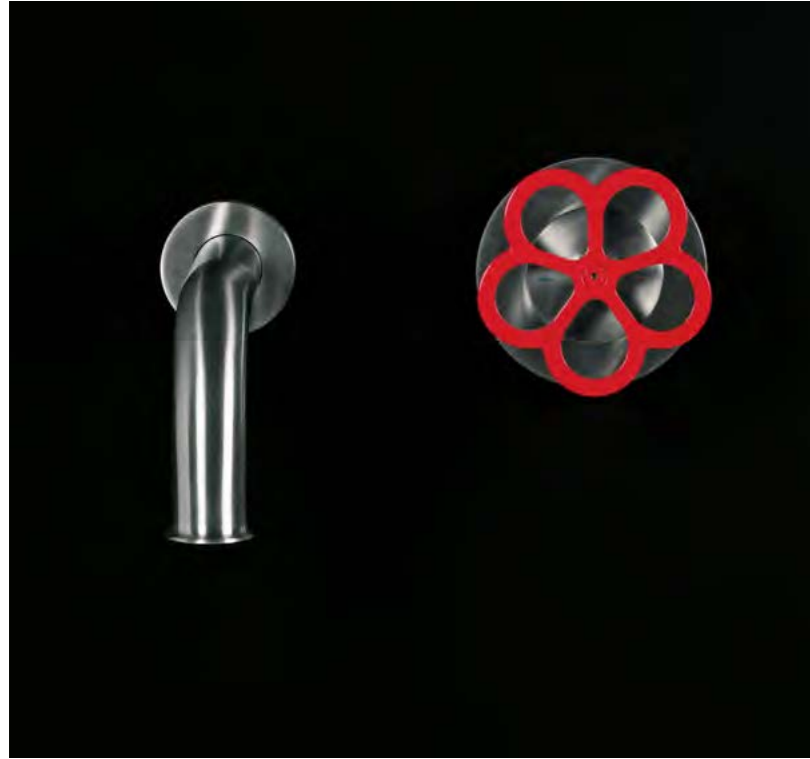

**Uni**  
CRS Boffi

**Uni**  
/ Rubinetteria in  
acciaio inox AISI 304,  
finitura satinata.  
/ Taps in satin  
stainless steel AISI 304.  
/ Robinetterie en acier  
inox satiné AISI 304.  
/ Armaturen aus  
Edelstahl AISI 304  
satinert.  
/ Grifería de acero  
inoxidable satinado  
AISI 304.







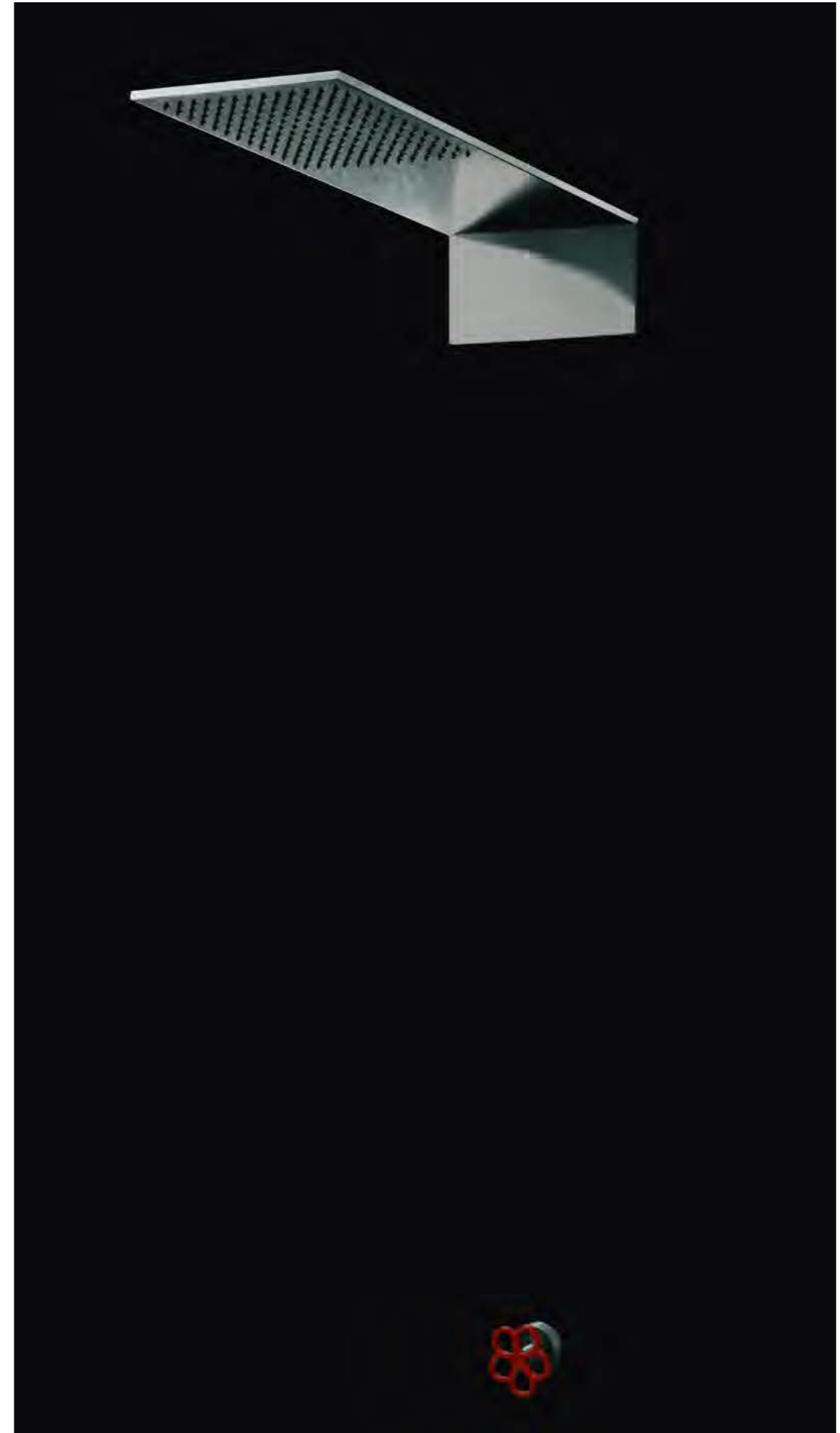

**W1**  
N. Wangen

**\* W1**

/ Rubinetteria in acciaio  
inox AISI 304, finitura  
satinata.

/ Taps in satin stainless  
steel AISI 304.

/ Robinetterie en acier  
inox satiné AISI 304.

/ Armaturen aus Edelstahl  
AISI 304 satiniert.

/ Grifería de acero inoxidable  
satinado AISI 304.

/

\* Disponibile fino ad  
esaurimento scorte  
Available until stock lasts



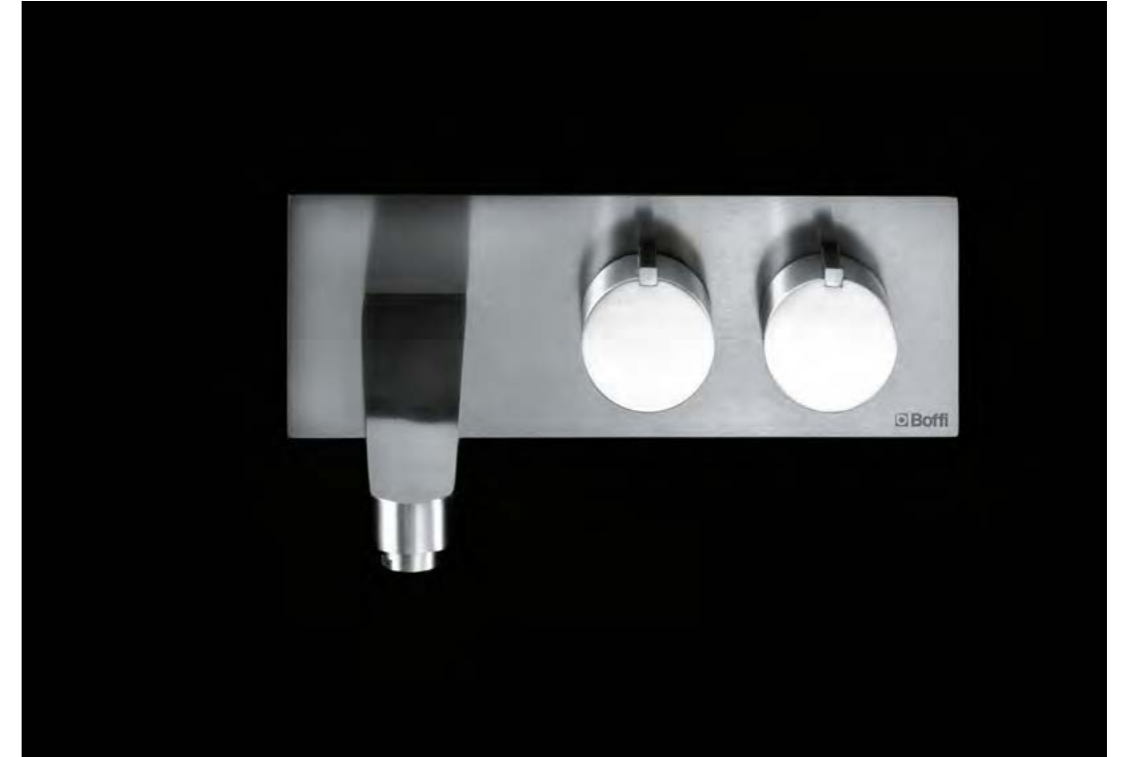

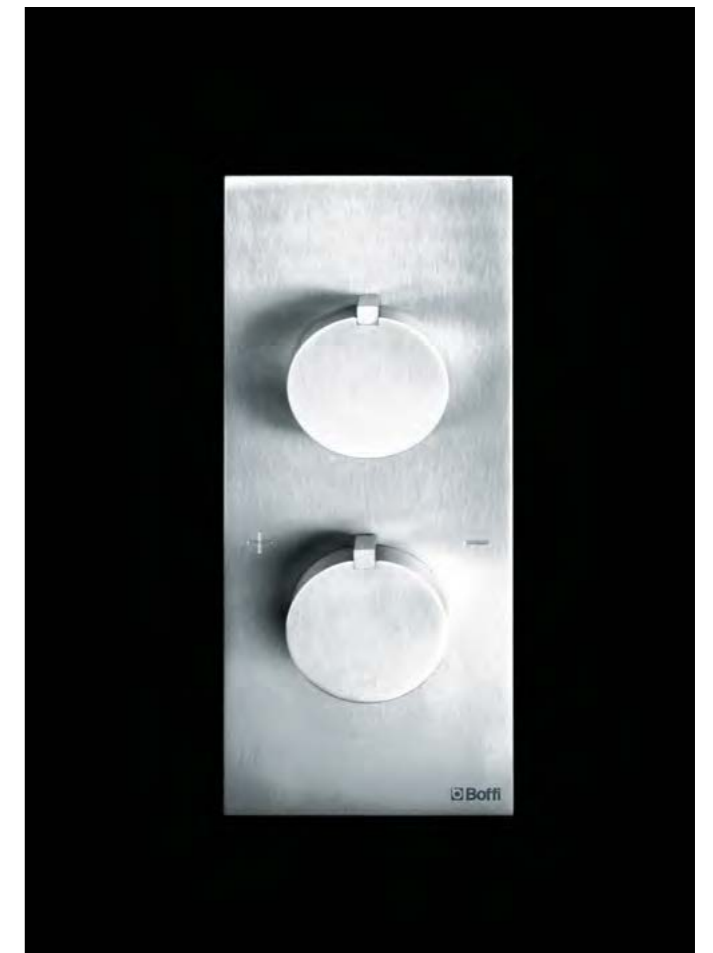
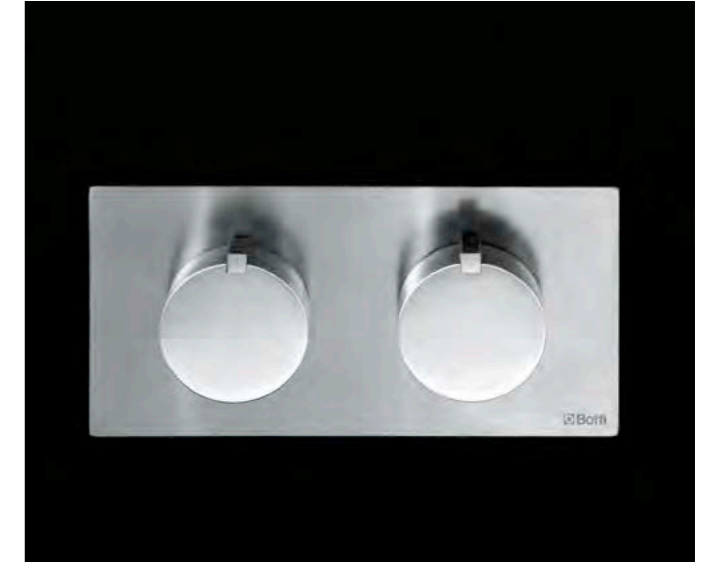
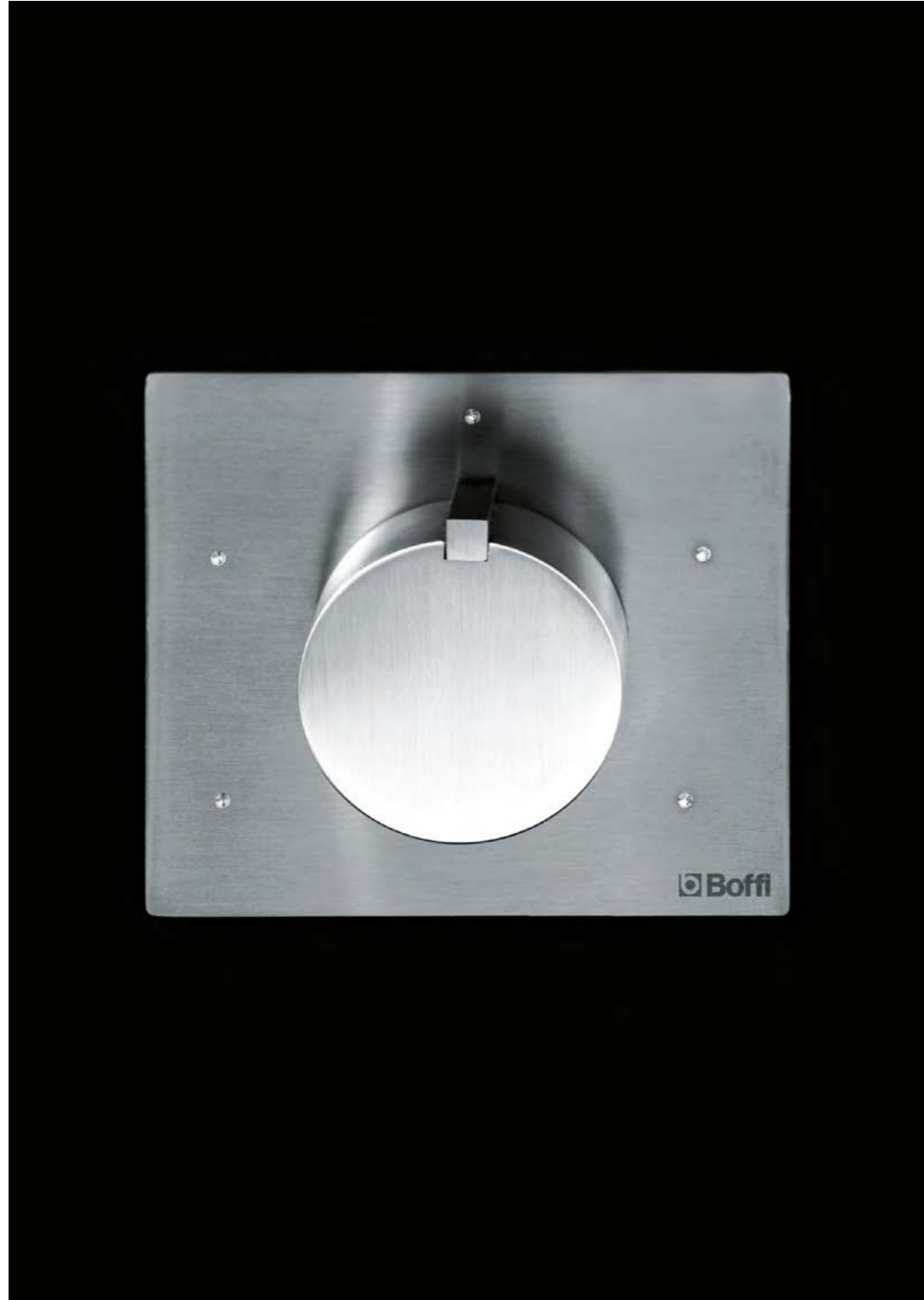





**Wings**

/ Rubinetteria in acciaio  
inox AISI 304, finitura  
satinata o lucida.  
/ Taps in stainless steel  
AISI 304, satinised  
or polished finish.  
/ Robinetterie en acier  
AISI 304, finition  
satinée ou poli.  
/ Armaturen aus  
Edelstahl AISI 304,  
satiniert oder glänzend.  
/ Griferia de acero  
inoxidable AISI 304,  
satinado o brillante.

/

**\* Finitura lucida:**  
disponibile fino  
ad esaurimento scorte  
**Polished finish:**  
available till the stock lasts



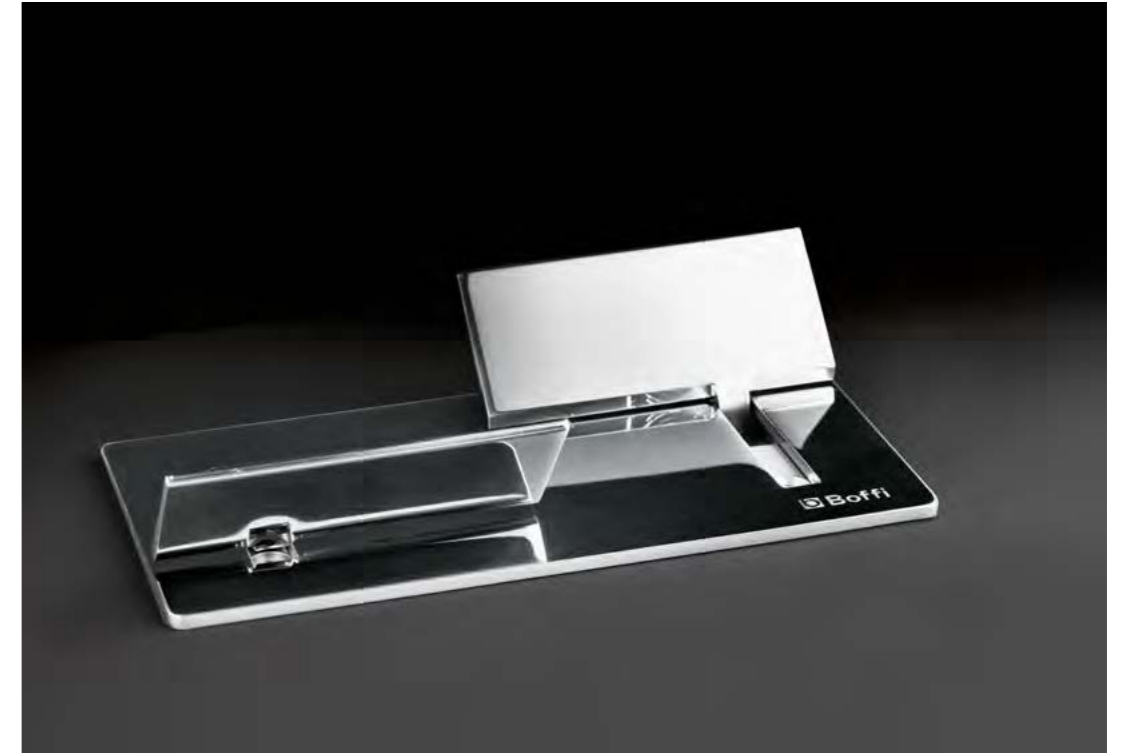





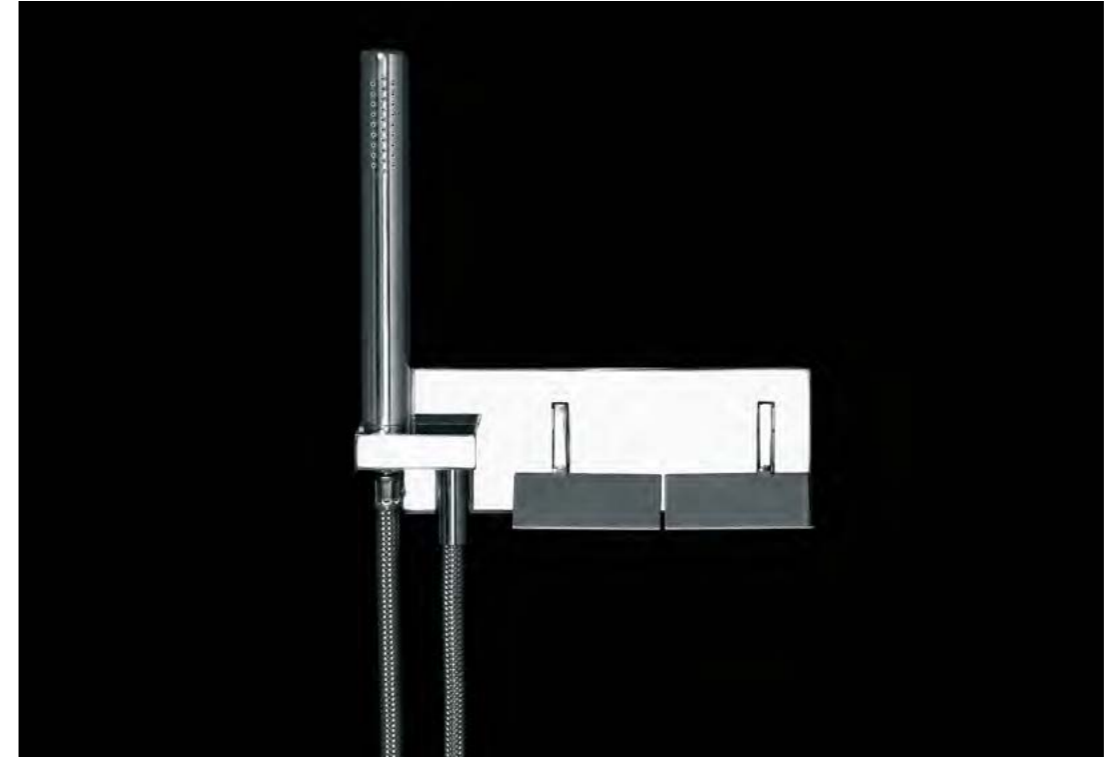

**Wings**  
M. Tessarollo



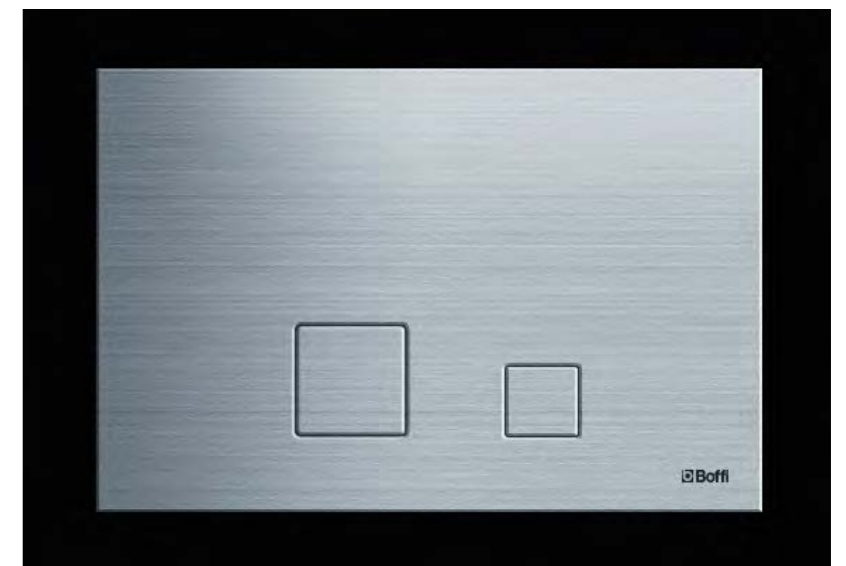

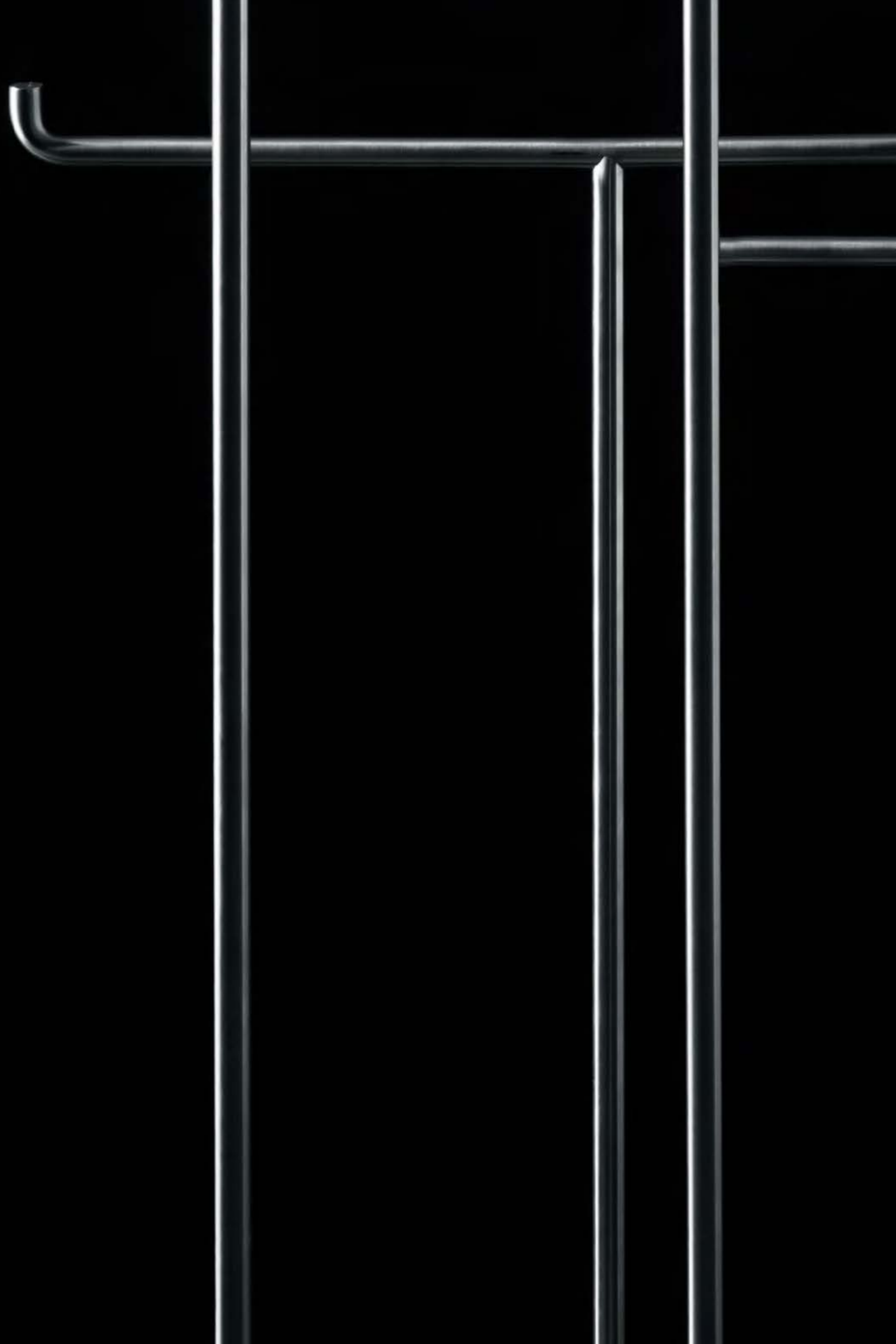

Accessori  
Accessories

<b>Blade</b> G. Landoni 2002	196
<b>Floe</b> K. Takeuchi 2018	209
<b>Iko</b> K. Oshiro 2014	210
<b>Minimal</b> G. Gianturco 2002	212
<b>Pipe</b> M. Wanders 2015	224
<b>RL11</b> L. e R. Palomba 1999	226
<b>Shortcut</b> Nendo 2010	232
<b>Skyline</b> neunzig° design 2011	234
<b>Twig</b> K. Takeuchi 2016	236



**Blade**  
/ Accessori da bagno,  
in acciaio inox AISI 304,  
finitura lucida – satinata –  
grigio grafite PVD.  
/ Bathroom accessories,  
in stainless steel AISI 304,  
polished – satin – PVD  
grey-graphite finish.  
/ Accessoires de salle de  
bain, en acier inox AISI  
304, finition poli – mat –  
gris graphite PVD.  
/ Zubehör für Bäder  
aus Edelstahl AISI 304,  
glänzend – satiniert –  
gräfitgrau PVD.  
/ Accesorios baño de  
acero inoxidable AISI 304,  
acabado brillante –  
satinado – gris grafito  
PVD.





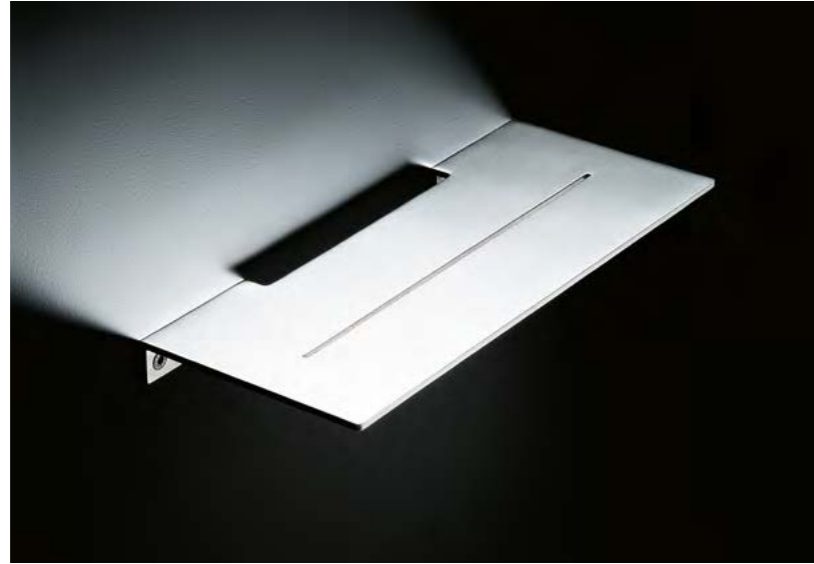









**Blade**  
G. Landoni



**Floe**  
K. Takeuchi



**Floe**  
Accessori bagno  
in Cristalplant® –  
marmo – pietra –  
granito.  
/ Accessories in  
Cristalplant® –  
marble – stone –  
granite.  
/ Accessoires  
salle de bain en  
Cristalplant® –  
marbre – pierre –  
granite.  
/ Badzubehör aus  
Cristalplant® –  
Marmor – Stein –  
Granit.  
/ Accesorios baño  
de Cristalplant® –  
mármol – piedra –  
granito.

**Iko**  
K. Oshiro

**Iko**  
/ Accessori bagno  
in tondino di acciaio  
inox satinato AISI 304,  
basamento in pietra  
Serena.  
/ Bathroom accessories  
in AISI 304 satin stainless  
steel rod, base in Serena  
stone.  
/ Accessoires salle  
de bain en fil d'acier inox  
satiné AISI 304, embase  
en pierre Serena.  
/ Zubehör für Bäder aus  
satinierem Edelstahlrohr  
AISI 304, Basis aus Stein  
Serena.  
/ Accesorios baño  
en redondo de acero  
inoxidable satinado  
AISI 304, base de piedra  
Serena.

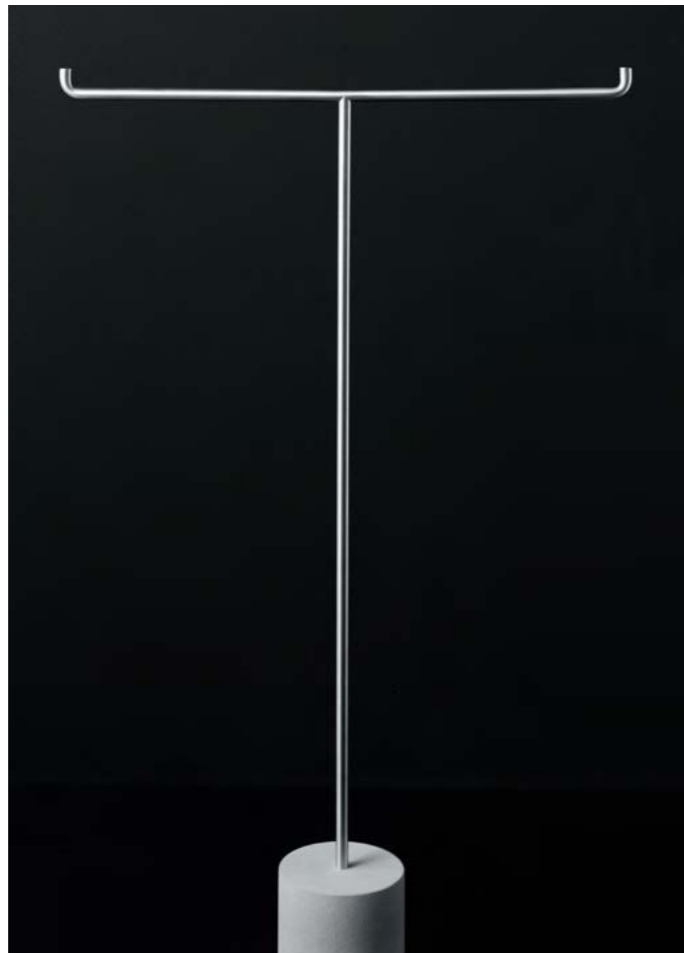



**Minimal**  
/ Accessori per bagno  
in acciaio inox AISI 304,  
finitura satinata.  
/ Bathroom accessories  
in stainless steel AISI 304,  
satin finish.  
/ Accessoires de salle  
de bain en acier inox  
AISI 304, finition mat.  
/ Zubehör für Bäder  
aus Edelstahl AISI 304,  
satinert.  
/ Accesorios baño de  
acero inoxidable AISI 304,  
acabado satinado.











Minimal

G. Gianturco

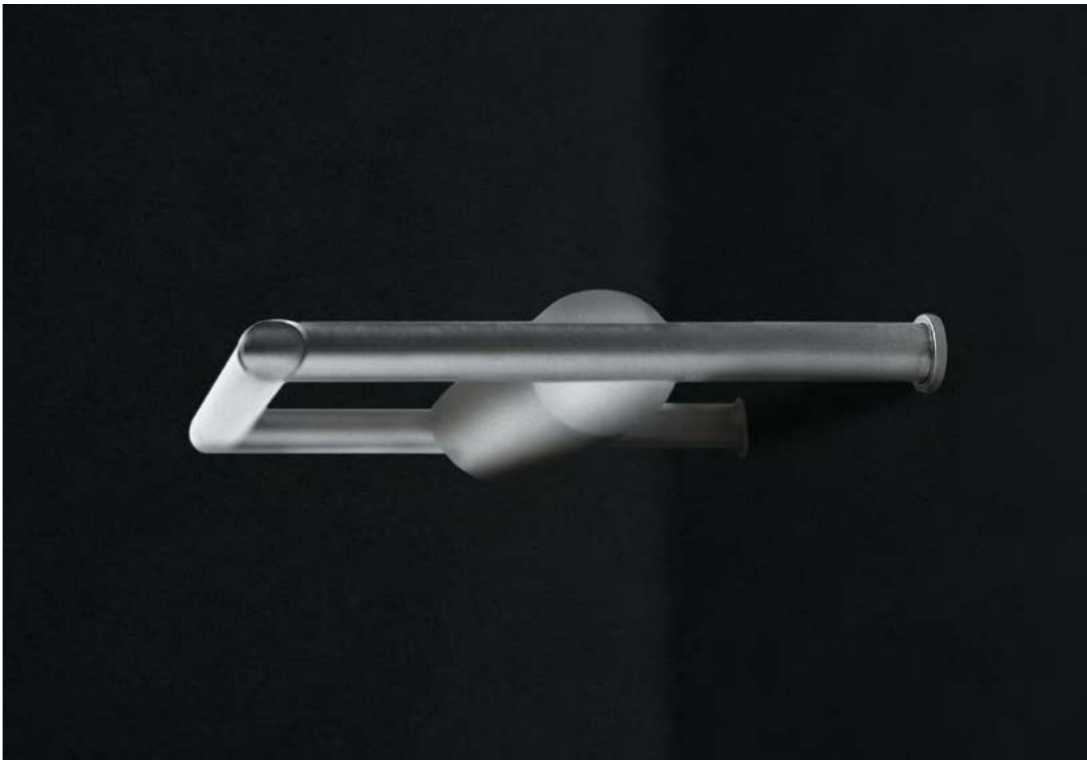
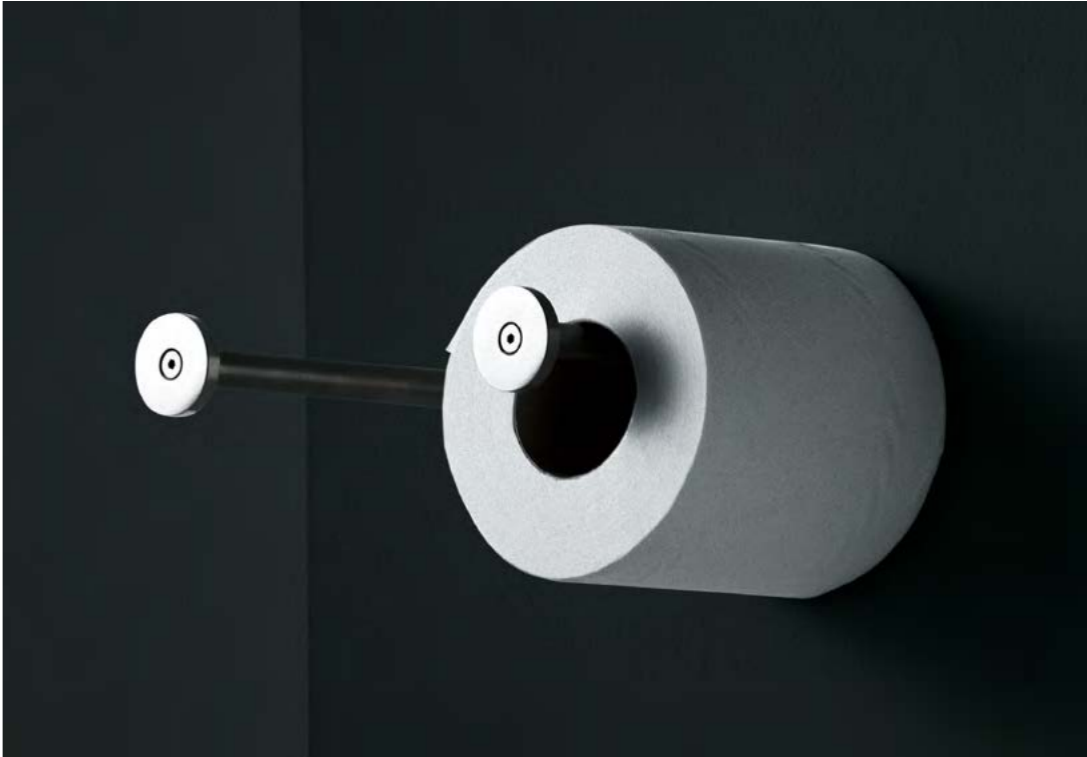

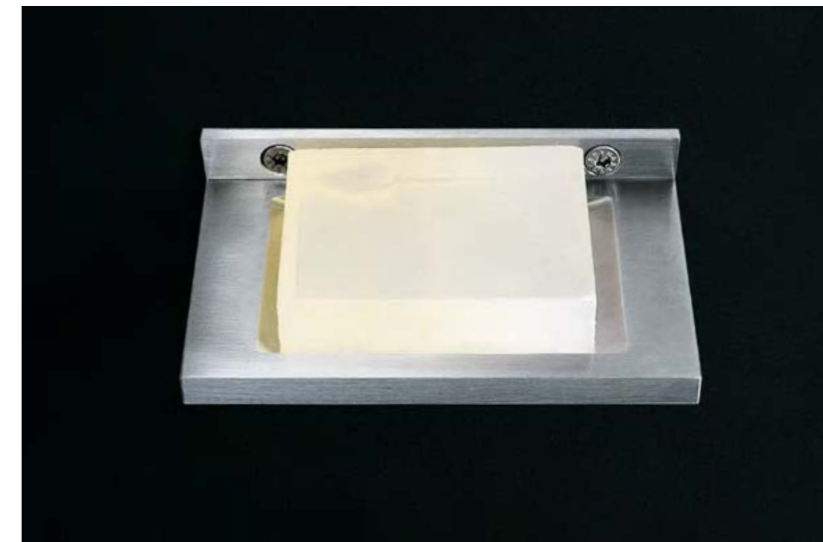
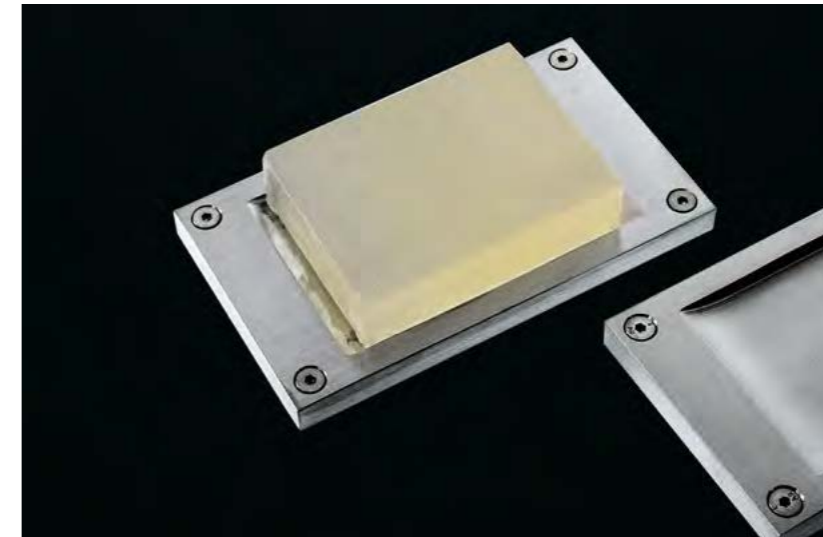

**Pipe**  
M. Wanders

**Pipe**  
/ Accessori per bagno  
in acciaio inox AISI 304.  
/ Bathroom accessories  
in stainless steel AISI 304.  
/ Accessoires de salle  
de bain en acier inox  
AISI 304.  
/ Zubehör für Bäder aus  
Edelstahl AISI 304.  
/ Accesorios baño de  
acero inoxidable AISI 304.

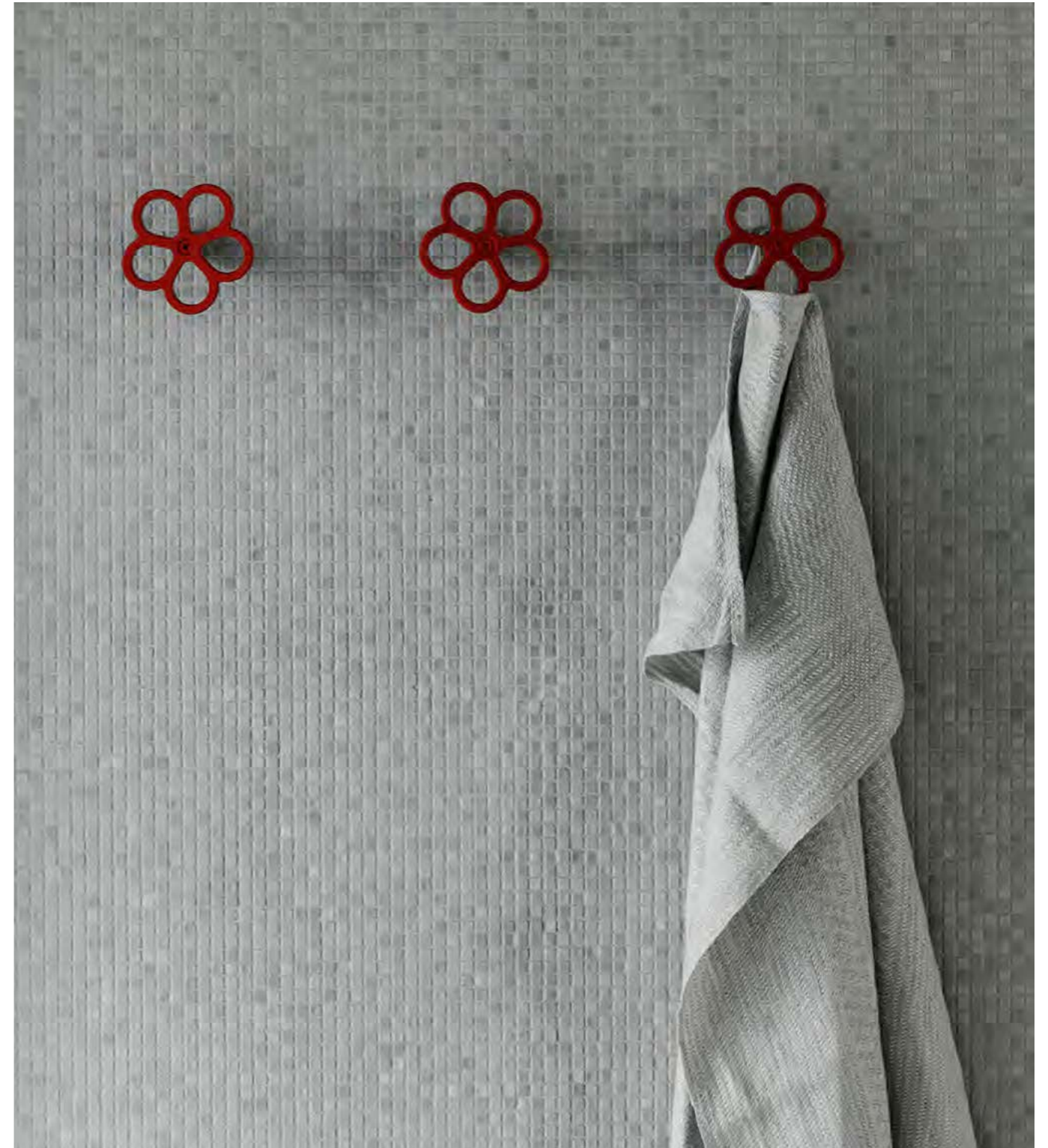



**RL11**  
/ Accessori per bagno  
in ceramica smaltata  
bianco lucido.  
/ Bathroom accessories  
in white polished  
enamelled ceramic.  
/ Accessoires de salle  
de bain en céramique  
émailée blanc poli.  
/ Zubehör für Bäder  
aus weißer Keramik,  
glasiert und glänzend.  
/ Accesorios baño  
de cerámica esmaltada  
blanco brillante.





RL11  
L. e R. Palomba

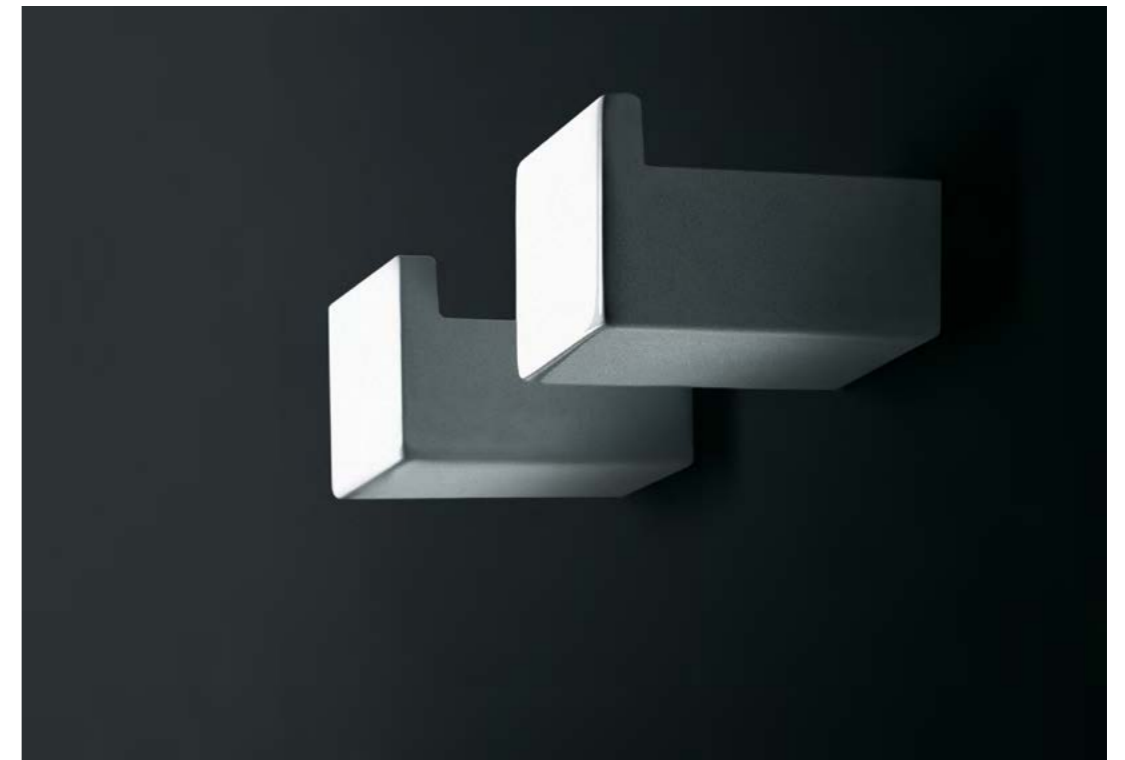

**Shortcut**  
Nendo

**Shortcut**

/ Serie di portasalvietta da terra, realizzati in tondino di acciaio AISI 304, verniciati con polveri epossidiche colore bianco opaco.  
/ Towel holders, made of rod in stainless steel AISI 304, varnished with epoxy powder, mat white.  
/ Série de porte-serviette sur pied, réalisés en fil d'acier AISI 304, peints avec poudres époxydiques couleur blanc mat.  
/ Serie von bodenbefestigten Handtuchhalter aus Rundstahl, Edelstahl AISI 304, lackiert mit Epoxy-Pulver, in den Farben weiß matt.  
/ Toalleros de acero inoxidable AISI 304, acabado blanco mate. Pintados con polvos epoxidicos.



**Skyline**  
neunzig° design

**Skyline**  
/ Accessori bagno  
in Corian® bianco.  
/ Bathroom accessories  
in white Corian®.  
/ Accessoires salle de  
bains en Corian® blanc.  
/ Zubehör für Bäder  
aus Corian® weiß.  
/ Accesorios baño  
en Corian® blanco.





**Twig**  
K. Takeuchi

**Twig**

/ Accessori da bagno  
in legno massello Iroko,  
Cristalplant® o Corian®  
bianco e acciaio inox  
con trattamento PVD  
o verniciato.

/ Accessories in Iroko  
solid wood, white  
Cristalplant® or Corian®  
and stainless steel  
treated with PVD coating  
technology or painted.

/ Accessoires salle de  
bain en bois massif Iroko,  
Cristalplant® ou Corian®  
blanc et acier inox avec  
traitement PVD ou peint.

/ Badzubehör in  
Massivholz Iroko,  
Cristalplant® oder Corian®  
weiß und Edelstahl  
mit PVDBeschichtung  
oder lackiert.

/ Accesorios de baño  
de madera maciza Iroko,  
Cristalplant® o Corian®  
blanco y acero inoxidable  
con tratamiento PVD o  
pintado.

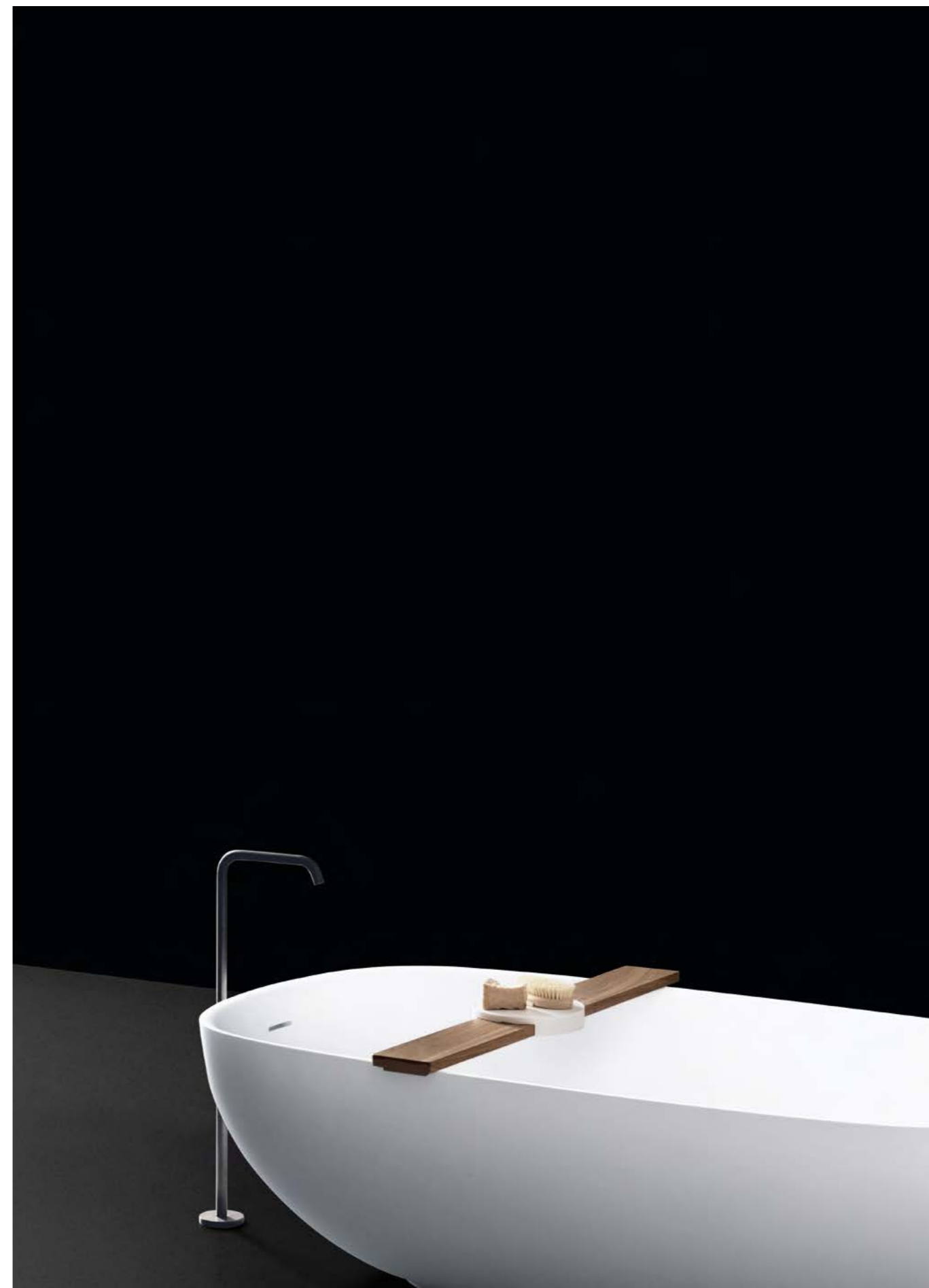





Complementi, Specchi, Lampade  
Complementary Items, Mirrors, Lamps

<b>Air</b> G. Gianturco 2002	242
<b>Air St</b> G. Gianturco 2013	244
<b>Ctline</b> V. Vasilev 2012	246
<b>Ctline Termo</b> V. Vasilev 2014	248
<b>Glass</b> P. Lissoni 2001	250
<b>Fire</b> G. Gianturco 2005	252
<b>Origine</b> A. Andreucci + C. Hoisl 2014	254
<b>Treves</b> P. Lissoni 2010	256
<b>Boccia</b> P. Lissoni 2012	260
<b>Giò</b> CRS Boffi 2012	262
<b>L.O.P.</b> CRS Boffi 2009	264
<b>Naviglio</b> P. Lissoni 1995	265
<b>Outliner</b> M. Schmitz 2014	266
<b>T18</b> CRS Boffi 2006	268
<b>Kaja</b> P. Jamieson 2008	269
<b>Elementi</b> E. Ossino 2017	270
<b>Index</b> F. Ferrone 2012	272
<b>Ledline</b> CRS Boffi 2015	274
<b>Lotus</b> N. Fukasawa 2014	276
<b>Solstice</b> P. Lissoni 2017	278
<b>SP14</b> neunzig° design 2014	280
<b>Square</b> CRS Boffi 1999	284
<b>Veneziana</b> P. Lissoni 2006	286
<b>Wk6</b> P. Lissoni 1998	288

**Air**  
G. Gianturco

**Air**  
/ Ventilatore agitatore  
da soffitto con pala  
in legno o verniciato nero.  
/ Ceiling fan with wood  
or varnished black vane.  
/ Ventilateur agitateur  
à fixer au plafond avec  
pales en bois naturel  
ou vernis noir.  
/ Deckenventilator mit  
Flügeln aus Naturholz  
oder schwarz lackiert.  
/ Ventilador agitador  
de techo con pala en  
madera o pintado negro.



**Air St**  
G. Gianturco

**Air St**  
/ Ventilatore agitatore  
da soffitto con pala  
in legno verniciato  
opaco nero o bianco.  
/ Ceiling fan with black  
or white matt painted  
vane.  
/ Ventilateur agitateur  
à fixer au plafond avec  
pales en bois, peint  
mat blanc ou noir.  
/ Deckenventilator mit  
Flügeln aus Holz,  
matt weiß oder schwarz  
lackiert.  
/ Ventilador agitador  
de techo con pala  
de madera barnizada  
blanco mate o negro.

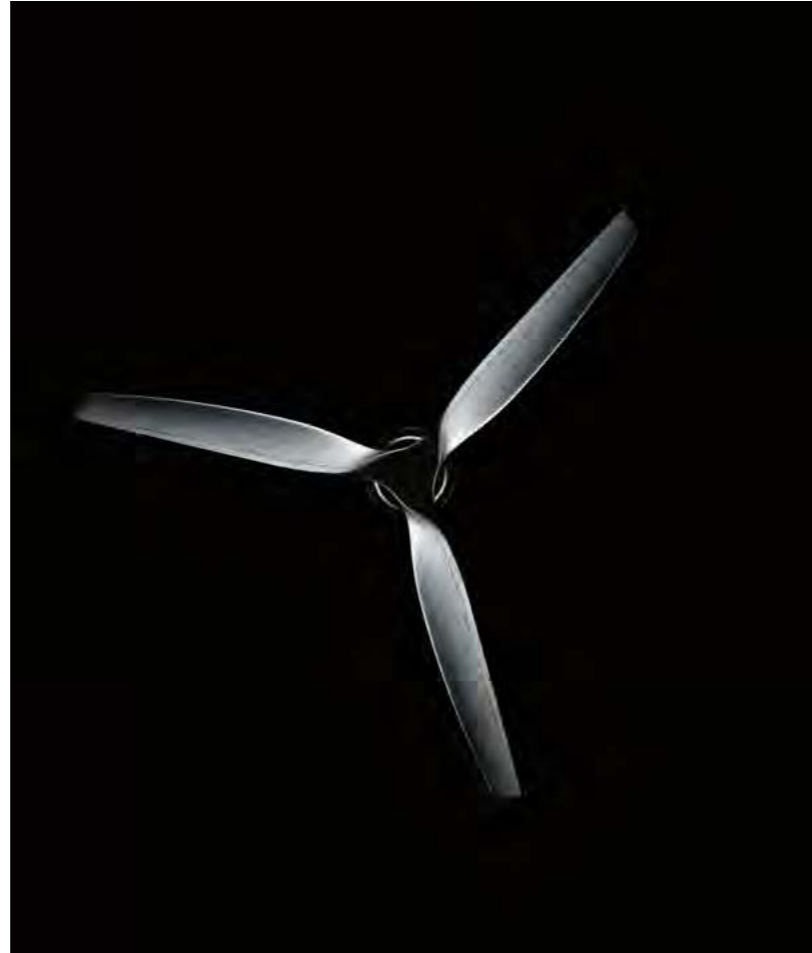

**Ct Line**  
V. Vasilev

**Ct Line**

/ Sistema componibile di contenitori a parete in solid surface bianco o in PaperStone® nero.  
/ Modular wall-mounted units made of white solid surface or in black PaperStone®.  
/ Système modulable d'éléments muraux réalisés en solid surface blanc ou en PaperStone® noir.  
/ Kombinierbare Schranksysteme aus matt weißem Solid Surface oder aus PaperStone® schwarz.  
/ Sistema componibile de contenedores de pared realizados en solid surface blanco o PaperStone® negro.



**Ct Line Termo**  
V. Vasilev

**Ct Line Termo**  
/ Termoarredo ad acqua calda o elettrico.  
/ Radiator, hot water version or electrical.  
/ Radiateur décoratif à eau chaude ou électrique.  
/ Design-Heizkörper mit Warmwasserbetrieb oder mit Elektrobetrieb.  
/ Radiador de agua caliente o eléctrico.



**Glass**  
P. Lissoni

**Glass**

/ Contenitori pensili a giorno in vetro temperato trasparente con schienale verniciato (bianco, grigio, nero, rosso o specchio).  
/ Open-faced wall units in tempered transparent glass with painted back panel (white, grey, black, red or mirror).  
/ Éléments hauts ouverts en verre trempé transparent avec panneau de fond peint (blanc, gris, noir, rouge ou miroir).  
/ Hängeschränk offen aus transparentem Hartglas mit Rückwand lackiert (weiß, grau, schwarz, rot oder Spiegel).  
/ Muebles altos abiertos de vidrio templado transparente con panel trasero pintado (blanco, gris, negro, rojo, espejo).









**Origine**  
/ Struttura fitness  
attrezzabile.  
/ Fitness equipment,  
which can be fitted  
with accessories.  
/ Structure fitness  
accessoirisable.  
/ Ausrüstbare Sportwand.  
/ Estructura fitness  
que se puede equipar.





**\* Treves**

/ Programma di contenitori pensile disponibili nella versione a giorno, con anta chiusa o con anta telaio + specchio.

Apertura a pressione.

/ Open-faced wall units, with door or frame door + mirror. Push opening.

/ Programme d'éléments haut disponibles dans la version ouverte, avec porte fermée ou avec porte cadre + miroir.

Ouverture automatique par pression.

/ Das Hängeschrank-Programm ist in der offenen Version, mit normalen Türen oder mit Rahmentür + Spiegel erhältlich. Automatisches Druck Öffnungssystem.

/ Programma de muebles contenedores altos disponibles en la versión abierta, con puerta cerrada o con puerta marco + espejo. Apertura automática asistida.

/

\* Disponibile fino ad esaurimento scorte  
Available until stock lasts





**Boccia**  
P. Lissoni

**Boccia**  
/ Lampada con diffusore  
in vetro opalino.  
/ Lamp with diffuser  
in opal glass.  
/ Lampe avec diffuseur  
en verre opalin.  
/ Leuchte mit Lampe  
aus Opalglas.  
/ Lámpara con difusor  
en cristal opalina.

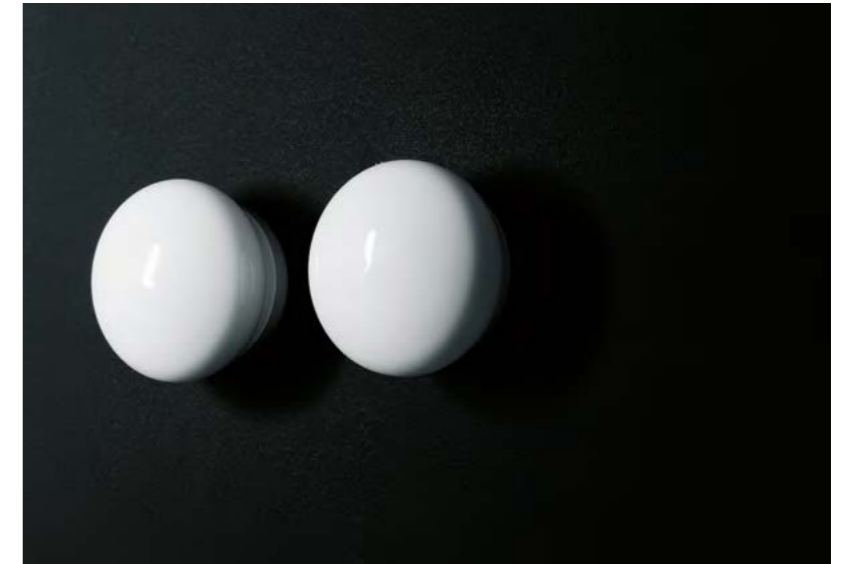

**Giò**  
/ Lampada a sospensione.  
/ Suspended lamp.  
/ Lampe suspendue.  
/ Hängelampe.  
/ Lámpara suspendida.

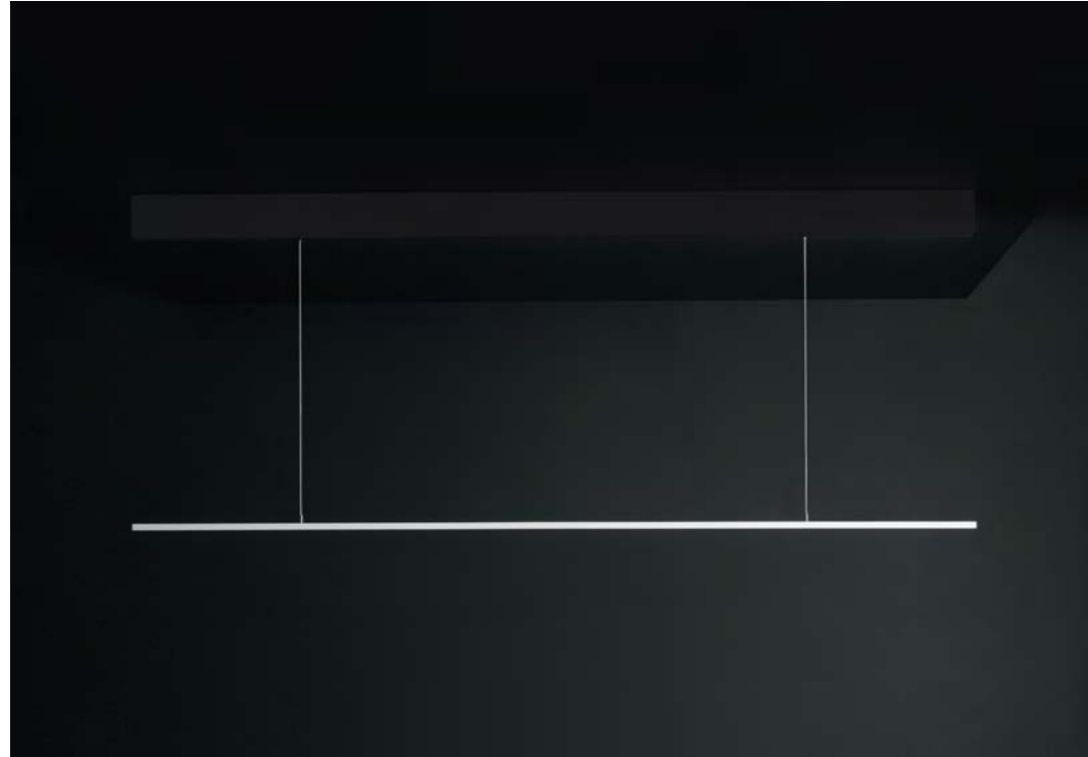

**Giò**  
/ Lampada a parete.  
Profilo di alluminio,  
con schermo protettivo  
in policarbonato.  
Finiture: verniciato nero  
e verniciato bianco.  
/ Wall lamp. Structure:  
aluminium profile,  
with protective screen  
in polycarbonate.  
Finishes: black painted -  
white painted.  
/ Lampe murale.  
Structure: profil  
d'aluminium, avec  
écran de protection  
en polycarbonate.  
Finitions: peint noir -  
peint blanc.  
/ Wandleuchte. Struktur:  
Profil aus Aluminium,  
mit Lampenschirm  
aus Polycarbonat.  
Ausführungen: lackiert  
schwarz - lackiert weiß.  
/ Lámpara de pared.  
Estructura: perfil de  
aluminio, con pantalla  
de protección de  
policarbonato.  
Acabados: pintado  
negro - pintado blanco.

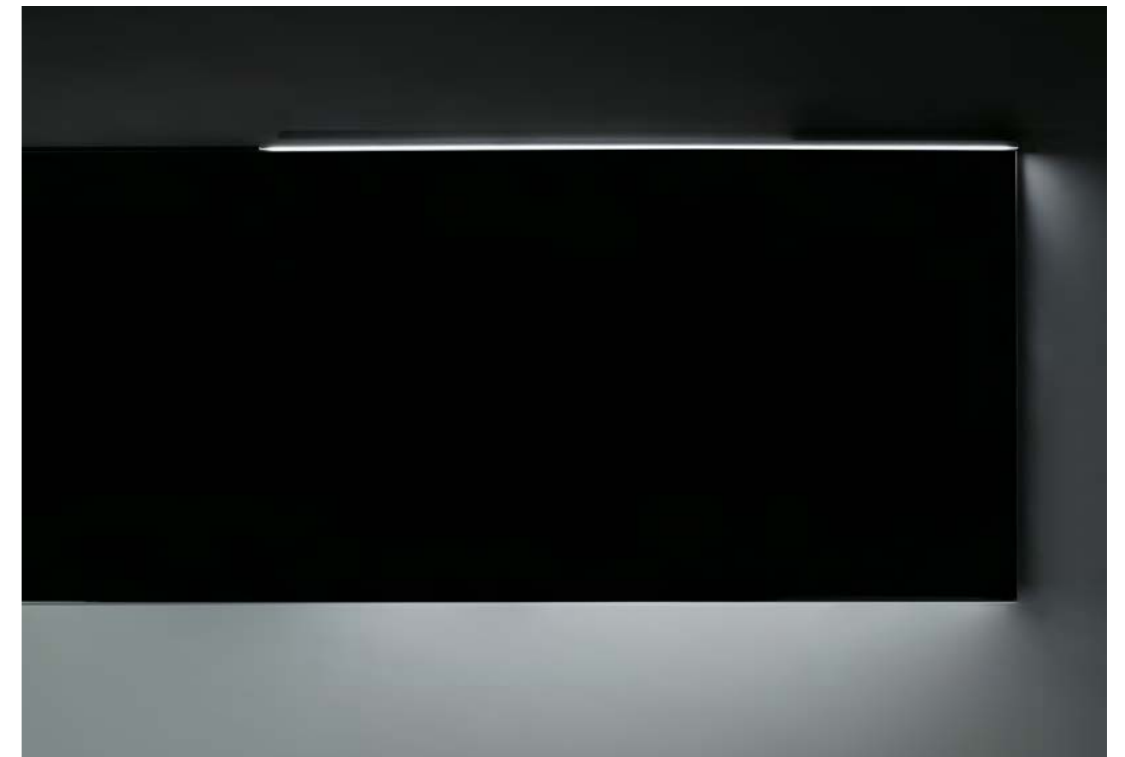

**L.O.P.**  
CRS Boffi



**L.O.P.**  
/ Lampada oscillante  
a sospensione.  
/ Suspended swinging  
lamp.  
/ Lampe oscillante  
à suspension.  
/ Pendelleuchte.  
/ Lámpara oscilante  
de suspensión.

**Naviglio**  
P. Lissoni

**Naviglio**  
/ Lampada per luce  
ad incandescenza,  
in alluminio tornito  
in lastra.  
/ Lamp for incandescent  
light, in sheet-turned  
aluminium.  
/ Lampes, ampoule  
à incandescente,  
en aluminium tourné  
en plaque.  
/ Aluminiumleuchte  
blechgedreht,  
mit Glühleuchte.  
/ Lámpara para luz  
de incandescencia,  
en aluminio torneado  
en capa.



**Outliner**  
M. Schmitz

**Outliner**  
/ Lampada a sospensione.  
/ Suspended lamp.  
/ Lampe suspendue.  
/ Hängelampe.  
/ Lámpara suspendida.





**T18**  
CRS Boffi

**T18**  
/ Sistema di illuminazione  
modulare ad elementi  
elettrificati a bassa  
tensione.  
/ Modular lighting system,  
composed by electrified  
elements with low  
consumption.  
/ Systèmes d'éclairage  
modulaires à éléments  
électrifiés à basse tension.  
/ Modulares Niedervolt-  
Beleuchtungssystem.  
/ Sistema de iluminación  
modular con elementos  
electrificados a baja  
tensión.



**Kaja**  
P. Jamieson

**Kaja**  
/ Specchio realizzato  
in plexiglass trasparente.  
/ Mirror in transparent  
plexiglass.  
/ Miroir en plexiglas  
transparent.  
/ Spiegel aus  
transparentem Plexiglas.  
/ Espejo en plexiglás  
transparente.

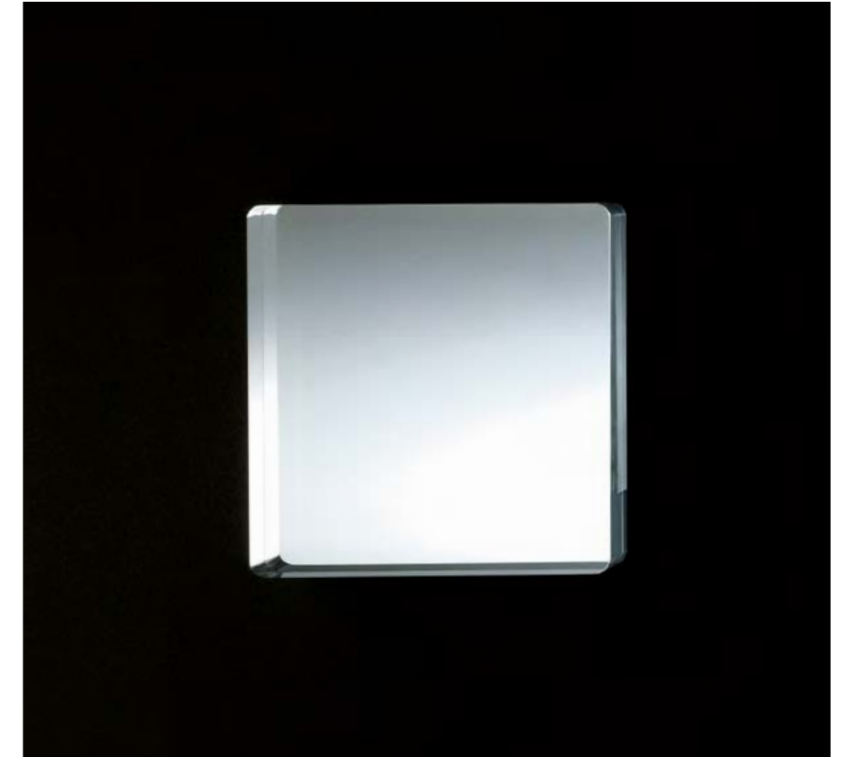

**Elementi**  
E. Ossino

**Elementi**

/ Specchiera con cornice in alluminio verniciato bronzo.

/ Mirror with frame in aluminium, bronze painted.

/ Miroir avec cadre en aluminium peint bronze.

/ Spiegel mit Rahmen aus Aluminium, lackiert Bronze.

/ Espejo con marco de aluminio pintado bronze.



**Index**

/ Specchio bifacciale,  
struttura cilindrica in  
acciaio inox satinato.  
Specchi assemblati  
su supporto girevole.  
/ Double-sided mirror,  
with cylinder shaped  
structure in satin stainless  
steel. Mirrors mounted  
on rotating support.  
/ Miroir double-face,  
avec structure cylindrique  
en acier inox satiné.  
Miroirs assemblés  
sur support pivotant.  
/ Zweiseitiger Spiegel,  
mit zylinderförmig aus  
satinierem Edelstahl.  
Auf drehbarem Träger  
montierte Spiegel.  
/ Espejo de dos caras,  
con estructura cilíndrica  
en acero inoxidable  
satinado. Espejos  
montados en soporte  
giratorio.



**Ledline**  
CRS Boffi

**Ledline**

/ Specchio orizzontale  
con mensola, con barra  
a LED singola.  
Telaio in alluminio.  
/ Horizontal mirror with  
shelf, with single LED bar.  
Thick aluminium frame.  
/ Miroir horizontal avec  
barre à LED individuelle.  
Cadre en aluminium.  
/ Horizontaler Spiegel  
mit Regal, mit einer LED-  
Leiste. Aluminiumrahmen  
Stärke.  
/ Espejo horizontal  
con ménsula, con barra  
LED individual. Armazón  
de aluminio.

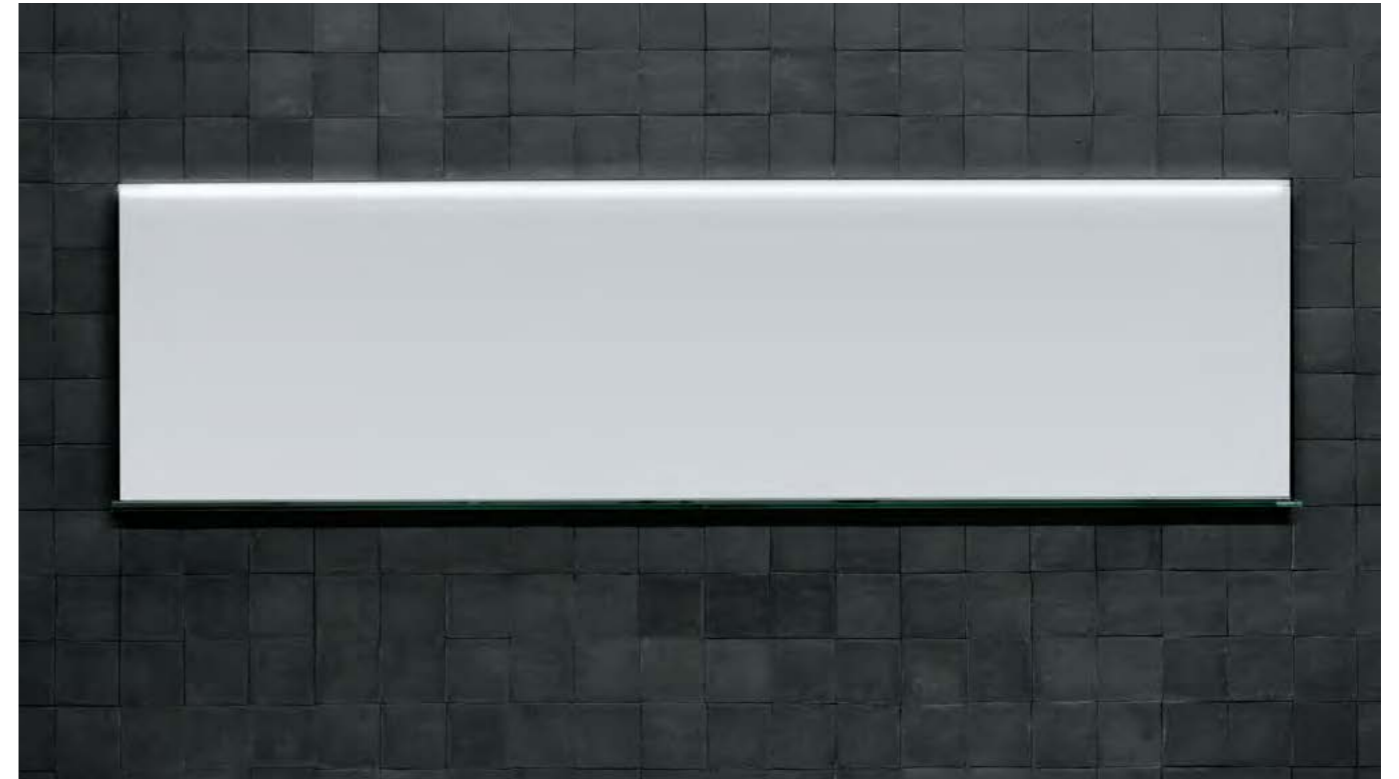

**Lotus**  
N. Fukasawa

**Lotus**  
/ Specchio.  
/ Mirror.  
/ Miroir.  
/ Spiegel.  
/ Espejo.

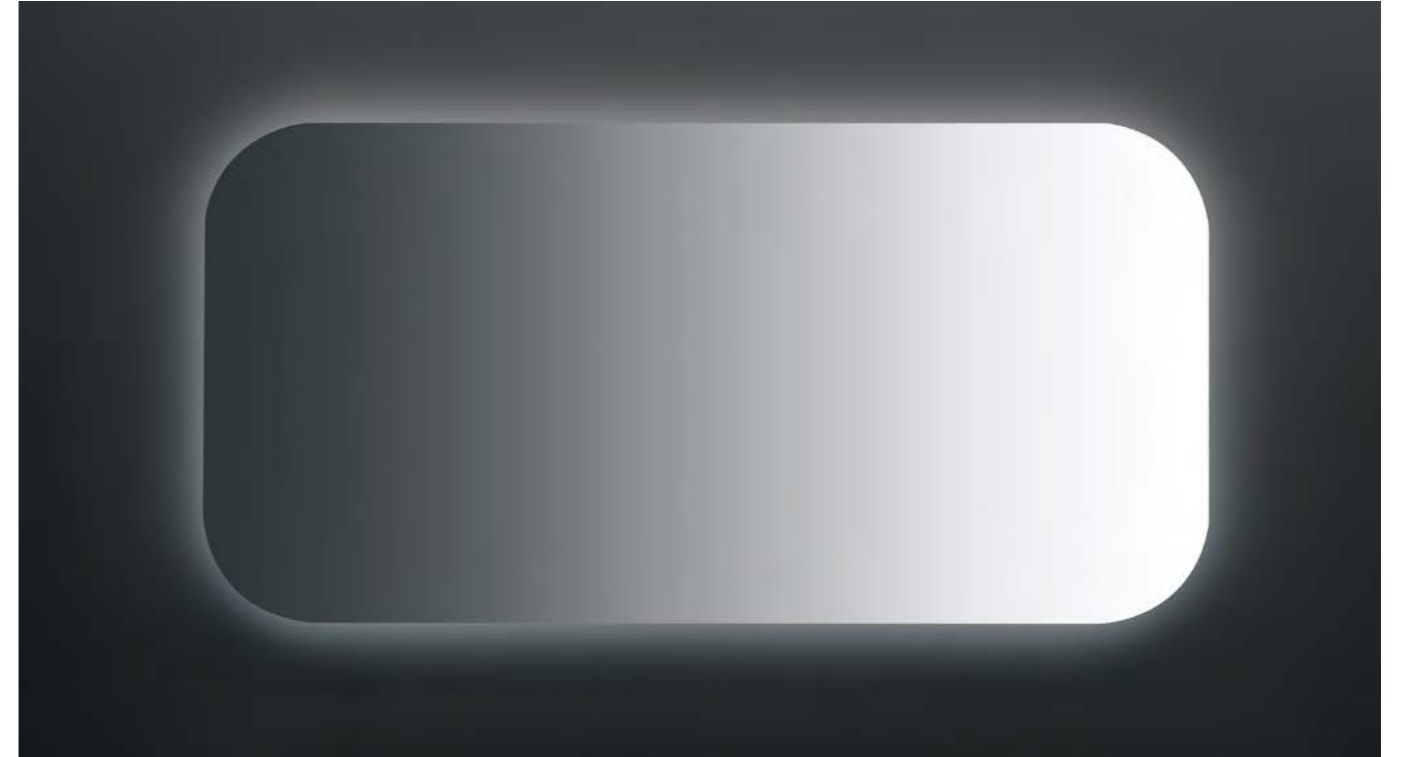
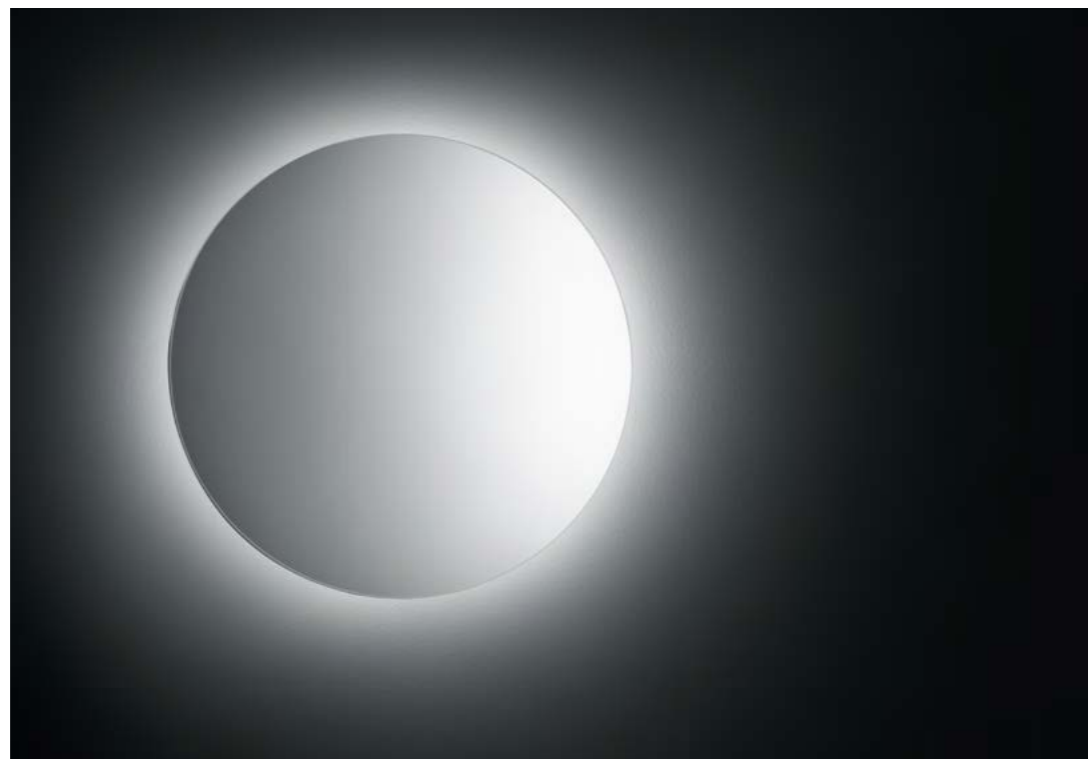
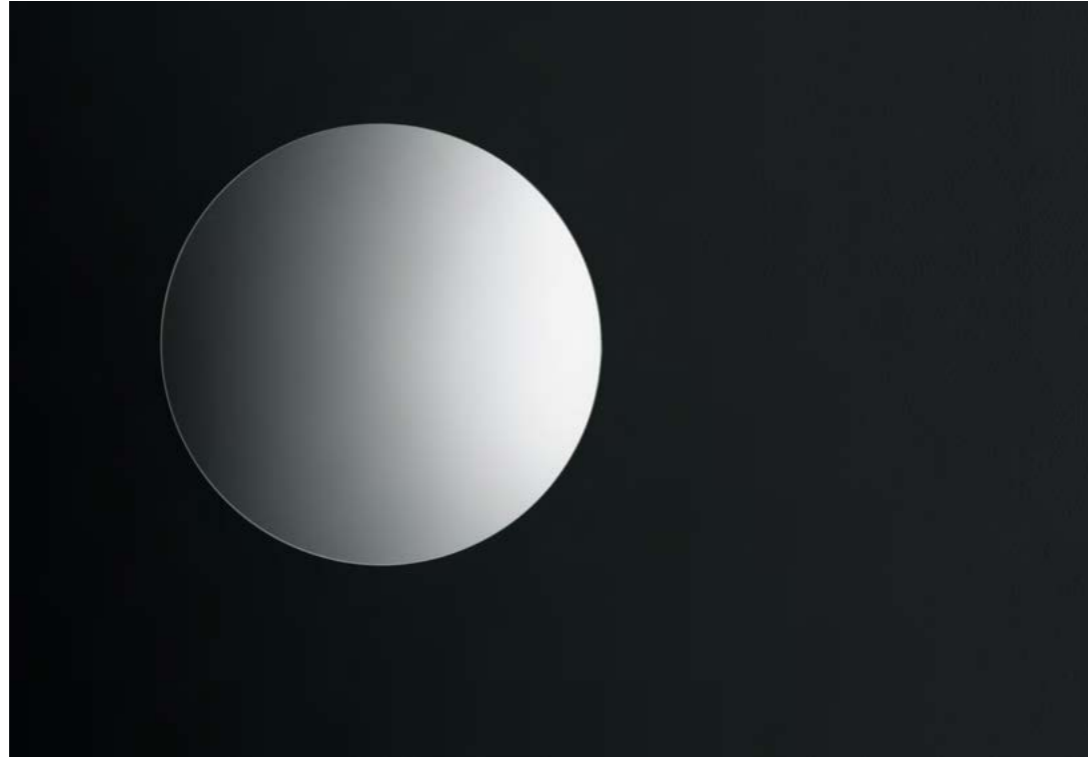

**Solstice**  
P. Lissoni

**Solstice**

/ Specchiera con  
supporto posteriore  
in MDF verniciato nero.  
/ Mirror with rear  
support in black  
painted MDF.  
/ Miroir avec support  
arrière en MDF  
peint noir.  
/ Spiegel mit rückse-  
itigem Träger in MDF  
schwarz lackiert.  
/ Espejo con soporte  
trasero de MDF  
pintado negro.

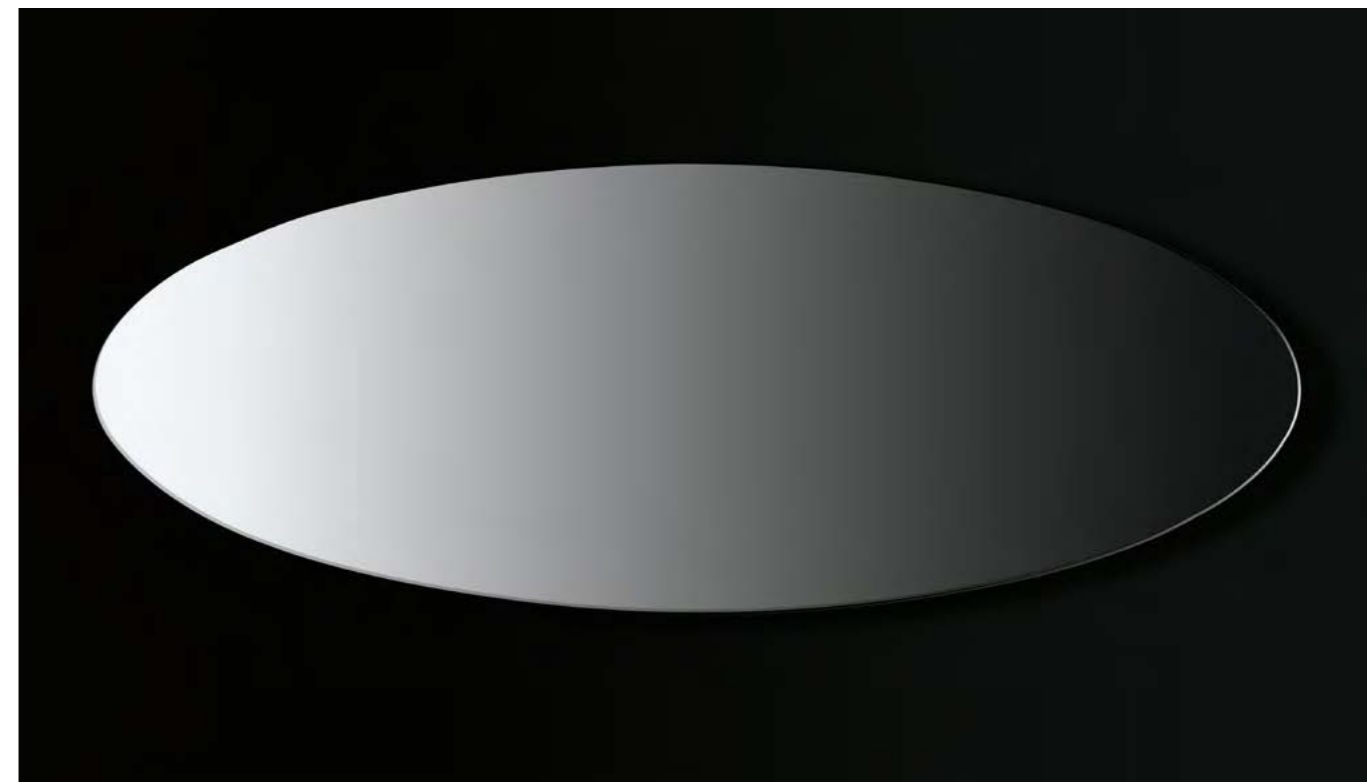
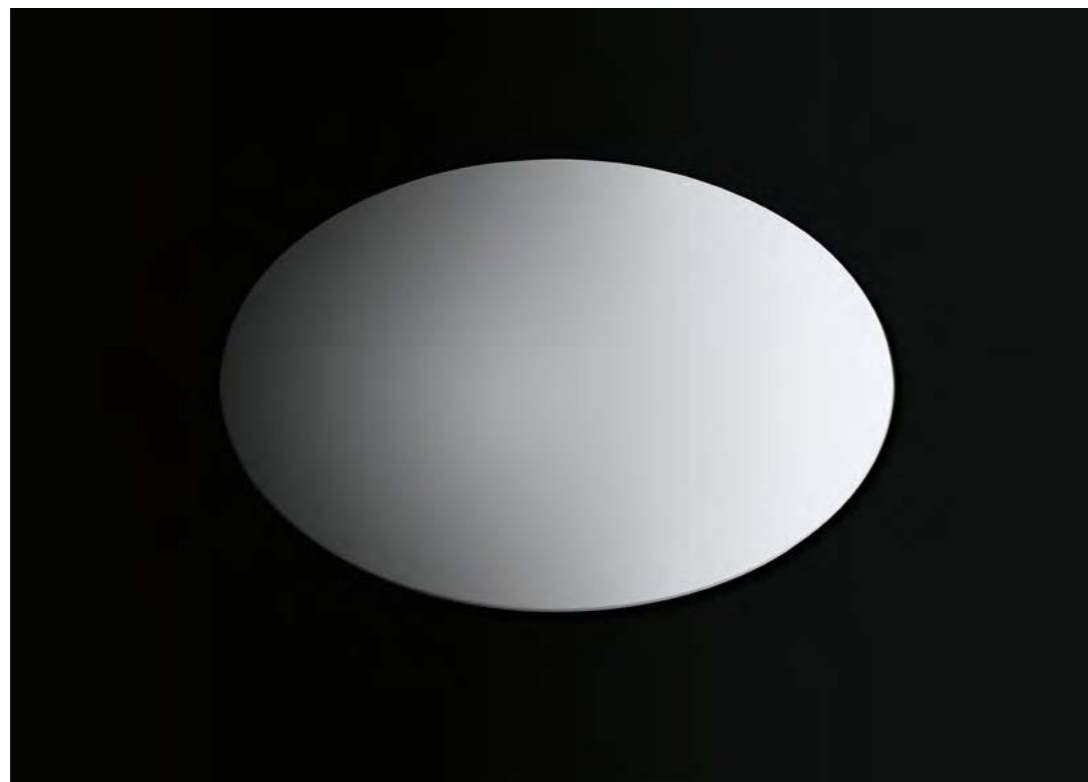



**SP14**

/ Specchio retro illuminato  
con cornice in finitura.  
/ Back illuminated mirror  
with finished frame.  
/ Miroir rétroéclairé avec  
cadre en finition.  
/ Spiegel mit rückseitiger  
Beleuchtung mit Rahmen  
in Ausführung.  
/ Espejo iluminado  
por detrás con marco  
en acabado.







**Square**  
CRS Boffi

**Square**

/ Specchio contenitore  
in alluminio anodizzato  
con anta.  
/ Mirror with compartment  
in anodised aluminium  
with door.  
/ Miroir/meuble en  
aluminium anodisé  
avec porte.  
/ Spiegelschrank aus  
eloxiertem Aluminium  
mit Tür.  
/ Espejo contenedor  
de aluminio anodizado  
con puerta.



**Veneziana**  
P. Lissoni

**Veneziana**  
/ Specchiera con cornice  
in specchio molato.  
/ Mirror with frame  
made of bevelled mirror.  
/ Miroir avec cadre  
en miroir meulé.  
/ Spiegel mit Aussenrand  
aus geschliffenem  
Spiegel.  
/ Espejo con marco  
de espejo biselado.

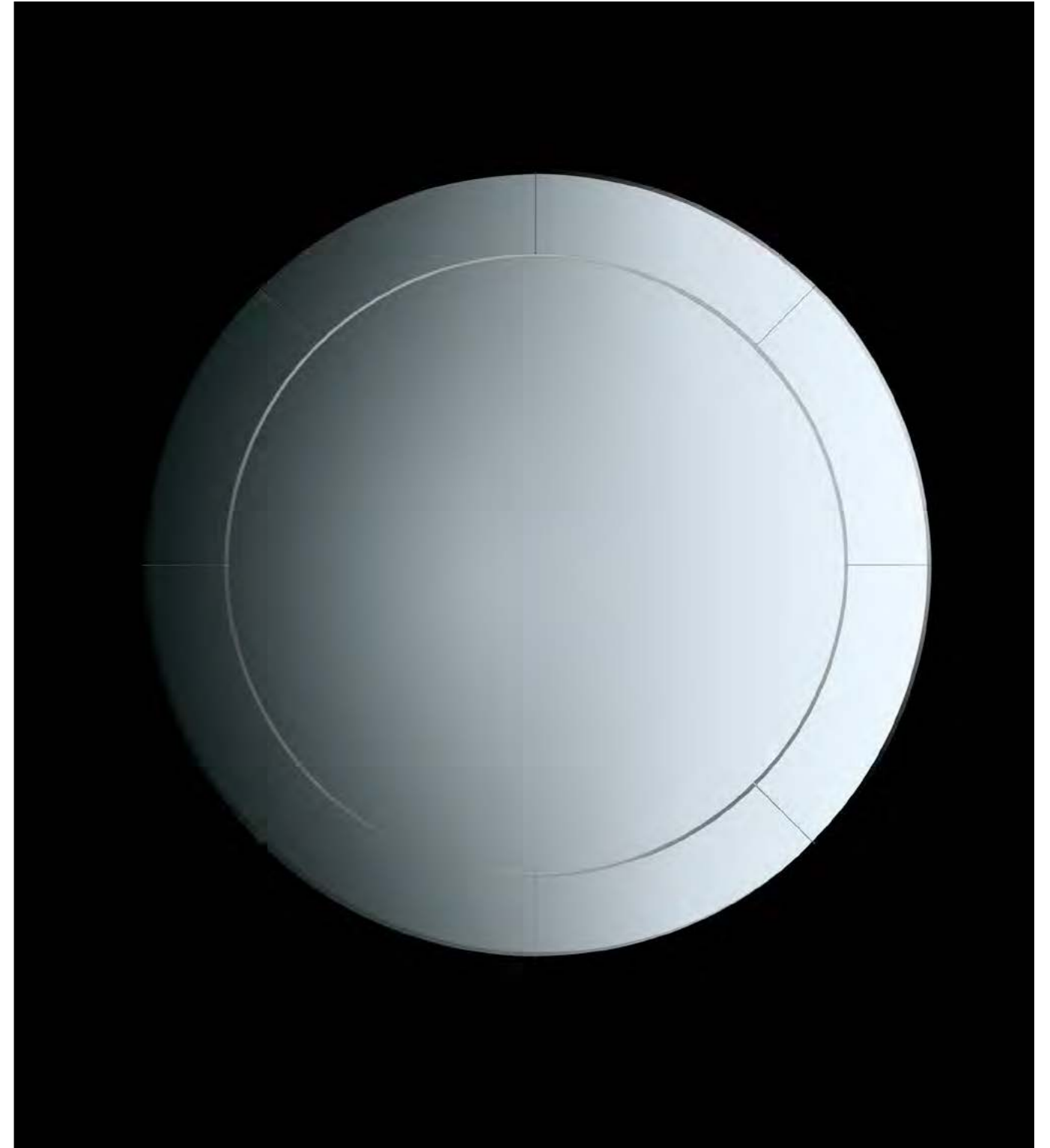
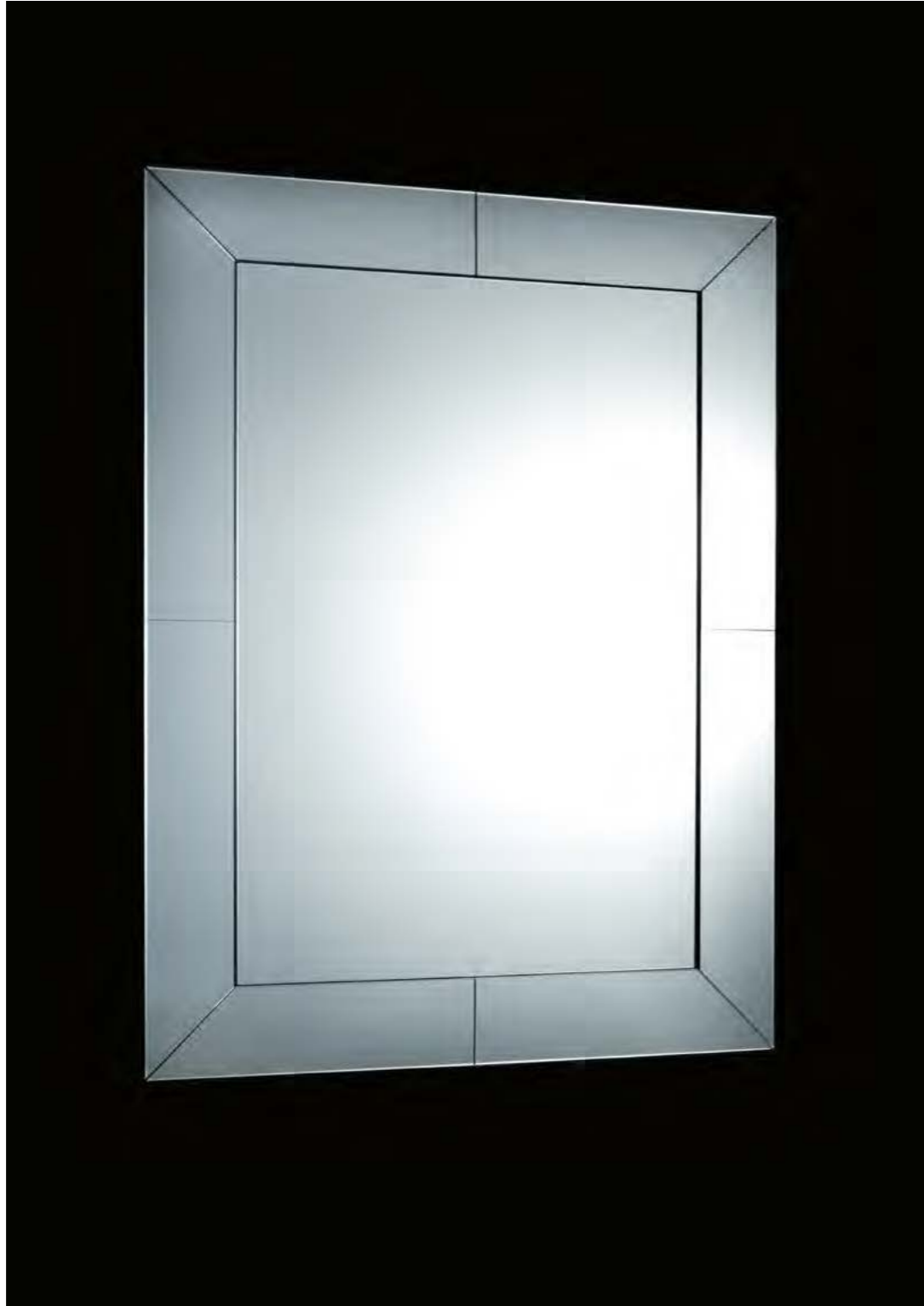

**Wk6**  
P. Lissoni

**WK6**  
/ Specchiera con  
telaio in alluminio.  
/ Mirror with  
aluminium frame.  
/ Miroir avec cadre  
en aluminium.  
/ Spiegel mit  
Aluminium-Rahmen.  
/ Espejo con armazón  
aluminio.

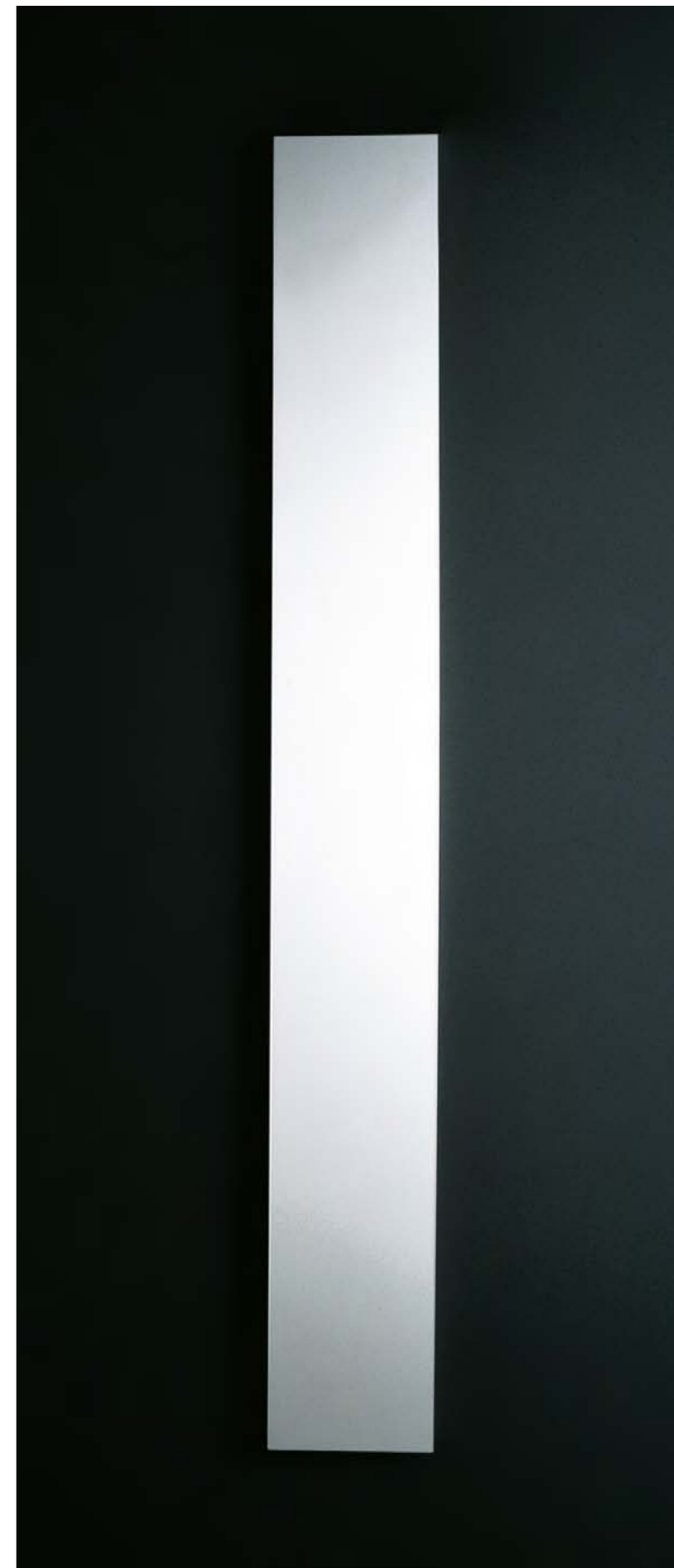
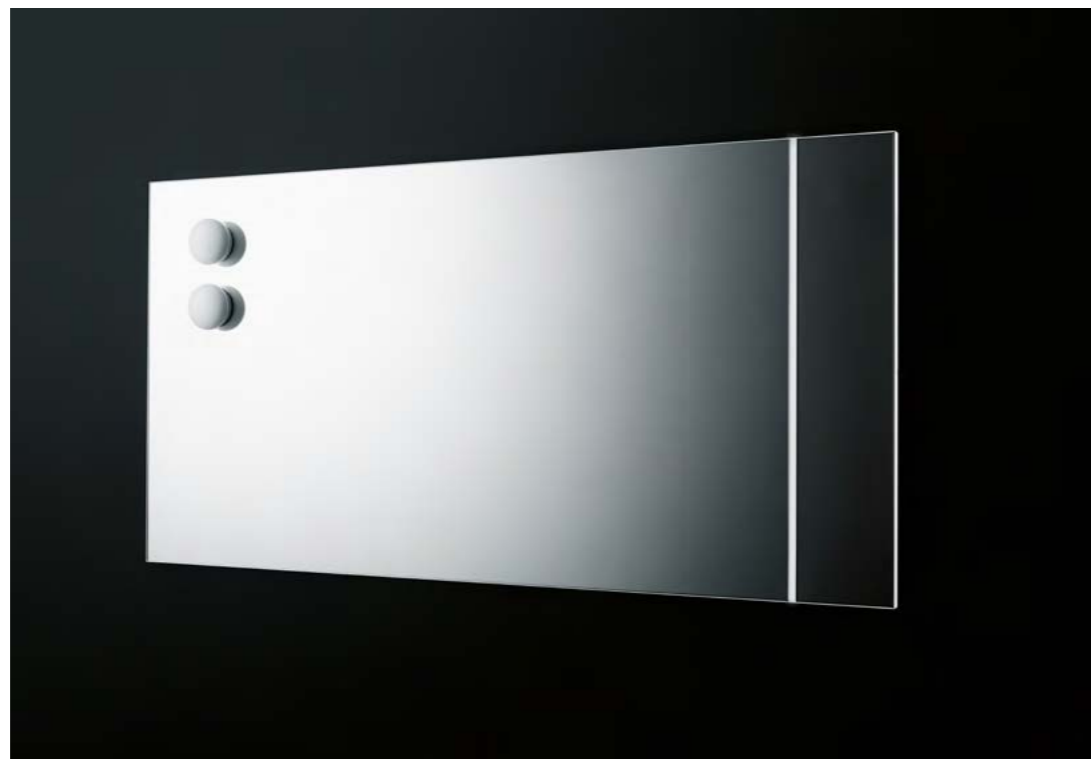
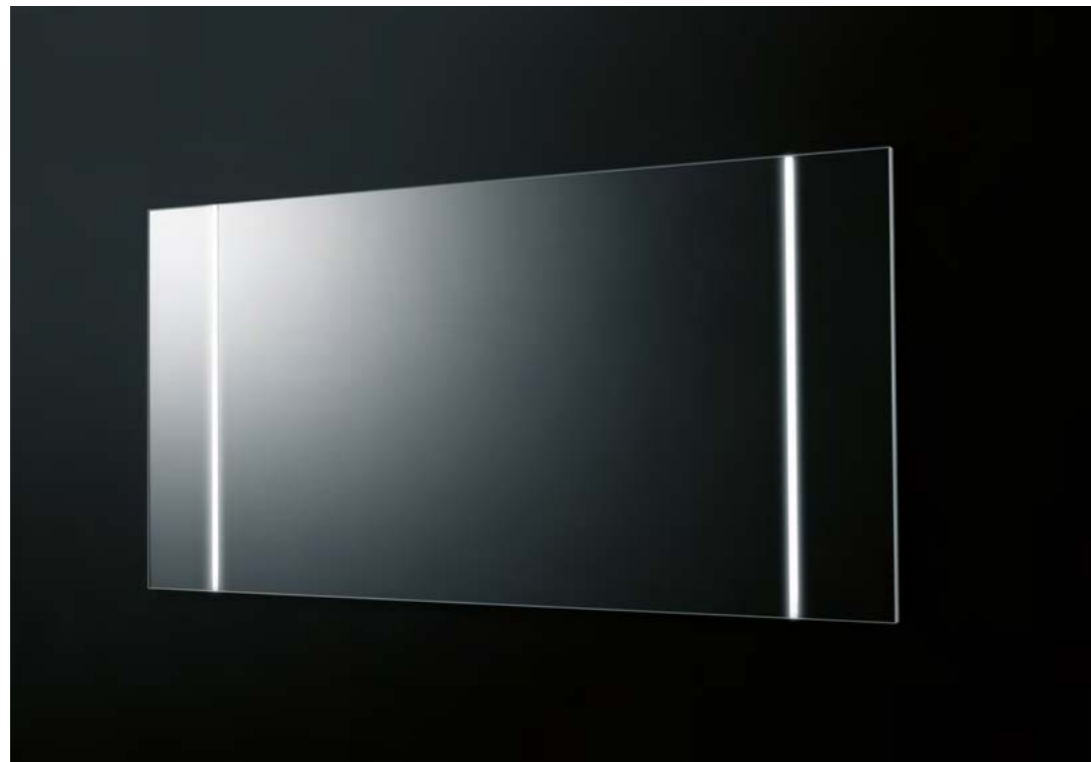

<b>Lavabi</b> Washbasins	292
<b>Vasche</b> Bathtubs	303
<b>Sanitari, Piatti, Cabine Doccia</b> Sanitary Fixtures, Shower Trays, Shower Boxes	308
<b>Rubinetti</b> Taps	315
<b>Accessori</b> Accessories	342
<b>Complementi, Specchi, Lampade</b> Complementary Items, Mirrors, Lamps	352

## Lavabi Washbasins

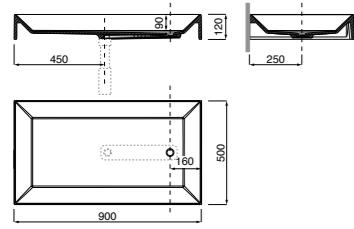

### A45

/ Lavabo d'appoggio in Cristalplant®, senza troppopieno. Con pianetto copri-scarico opzionale in Cristalplant® o legno massello. Disponibile versione sospesa con staffe. L. 900 P. 500 H. 120 mm. WRAQAE01.  
/ Top-mounted washbasin in Cristalplant®, without overflow. With optional drain-hole covering shelf in Cristalplant® or solid wood. Suspended version available with supporting brackets. L. 900 P. 500 H. 120 mm. WRAQAE01.  
/ Lavabo d'appui en Cristalplant® blanc, sans trop-plein. Avec petit plan couvre-écoulement en option, en Cristalplant® ou bois massif. Version suspendu avec brides de support. L. 900 P. 500 H. 120 mm. WRAQAE01.  
/ Aufgebautes Waschbecken aus Cristalplant® weiß ohne Überlauf. Mit Auslauf-Abdeckplatte, optional, aus Cristalplant® oder Massivholz. Auch wandbefestigt mit Trägerbügel. L. 900 P. 500 H. 120 mm. WRAQAE01.  
/ Lavabo apoyado en Cristalplant®, sin rebosadero. Con tablero cubre-desagüe opcional en Cristalplant® o madera maciza. También suspendido con estribos de soporte. L. 900 P. 500 H. 120 mm. WRAQAE01.

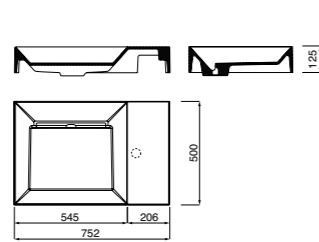

### A45 Compact

/ Lavabo in Cristalplant®, senza troppopieno. Anche SOSPESO: ordinare separatamente staffe. L. 752 P. 500 H. 125 mm. Cod. WRAQAE02.  
/ Washbasin in Cristalplant®, without overflow. SUSPENDED version available too: please order separately the supporting brackets. L. 752 P. 500 H. 125 mm. Cod. WRAQAE02.  
/ Lavabo en Cristalplant®, sans trop-plein. Même SUSPENDU: commander séparément des brides. L. 752 P. 500 H. 125 mm. Cod. WRAQAE02.  
/ Waschbecken aus Cristalplant®, ohne Überlauf. Auch WANDBEFESTIGT: Trägerbügel getrennt bestellen. L. 752 P. 500 H. 125 mm. Cod. WRAQAE02.  
/ Lavabo en Cristalplant®, sin rebosadero. También SUSPENDIDO: pedir estribos por separado. L. 752 P. 500 H. 125 mm. Cod. WRAQAE02.

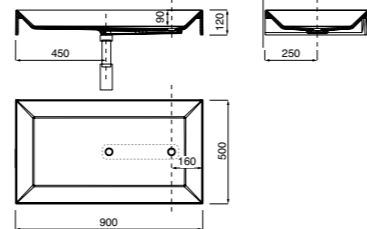

### A45 Stone

/ Lavabo in marmo bianco di Carrara, senza troppopieno. Pianetto copri-scarico opzionale, da ordinare separatamente. Anche SOSPESO: ordinare separatamente staffe. L. 900. P. 500 H. 120 mm. Cod. WMAQAE01.  
/ Washbasin in white Carrara marble, without overflow. Optional drain-hole covering shelf, to be ordered separately. SUSPENDED version available too: please order separately the supporting brackets. L. 900 P. 500 H. 120 mm. Cod. WMAQAE01.  
/ Lavabo en marbre blanc Carrara, sans trop-plein. Petit plan couvre-écoulement en option, à commander séparément. Même SUSPENDU: commander séparément des brides. L. 900 P. 500 H. 120 mm. Cod. WMAQAE01.  
/ Waschbecken in Carrara-Marmor weiß, ohne Überlauf. Auslauf-Abdeckplatte, optional, getrennt bestellen. Auch WANDBEFESTIGT: Trägerbügel getrennt bestellen. L. 900 P. 500 H. 120 mm. Cod. WMAQAE01.  
/ Lavabo de mármol blanco Carrara, sin rebosadero. Tablero cubre-desagüe opcional, a pedir por separado. También SUSPENDIDO: pedir estribos por separado. L. 900 P. 500 H. 120 mm. Cod. WMAQAE01.

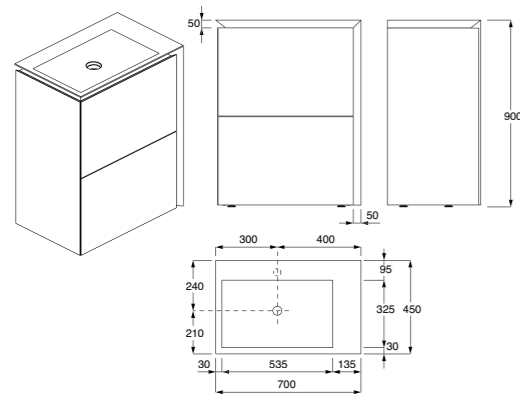

### B15

/ Base monoblocco portallavabo con piano e spalla in marmo, con vasca lavamani integrata nel piano, senza troppopieno, completo di sifone e piletta cromati, tappo in marmo. Fianco base sottolavabo e frontali cassetto in finitura. H. 900 L. 700 prof. 450 mm. Marmo bianco Carrara WMNWMB03 S-D. Marmo nero Marquinia WMNWMB04 S-D.  
/ Monoblock unit for washbasin with top and side panel in marble, with basin integrated in the top, without overflow, with chromium-plated siphon and waste drain and marble plug. Side panel of the base unit for washbasin and drawer fronts in finish. H. 900 W. 700 D. 450 mm. White Carrara marble WMNWMB03 S-D, black Marquinia marble WMNWMB04 S-D.  
/ Base porte-lavabo avec plan lavabo et panneau vertical en marbre. Lavabo sans trop-plein, muni de siphon et bonde chromés, bouchon en marbre. Côté et façades tiroir en finitions. H. 900 L. 700 prof. 450 mm. Marbre blanc Carrara WMNWMB03 S-D. Marbre noir Marquinia WMNWMB04 S-D.

/ Blockunterschrank für Waschbecken mit Waschtischplatte und Seitenteil aus Marmor, mit Handwaschbecken integriertem in Waschtischplatte, ohne Überlauf, mit verchromtem Siphon und Ablauf, Verschluss aus Marmor. Unterschrank für Waschbecken mit Seite und Schubladen-fronten in Ausführung. H. 900 B. 700 Tiefe 450 mm. Carrara-Marmor weiß WMNWMB03 S-D. Marquinia-Marmor schwarz WMNWMB04 S-D.  
/ Mueble bajo para lavabo con costado y frentes cajón en acabado. Encimera lavabo y panel trasero de mármol. Lavabo sin rebosadero, dotado de sifón y válvula cromados, tapón de mármol. H. 900 L. 700 P. 450 mm. Mármol blanco Carrara WMNWMB03 S-D. Mármol negro Marquinia WMNWMB04 S-D.

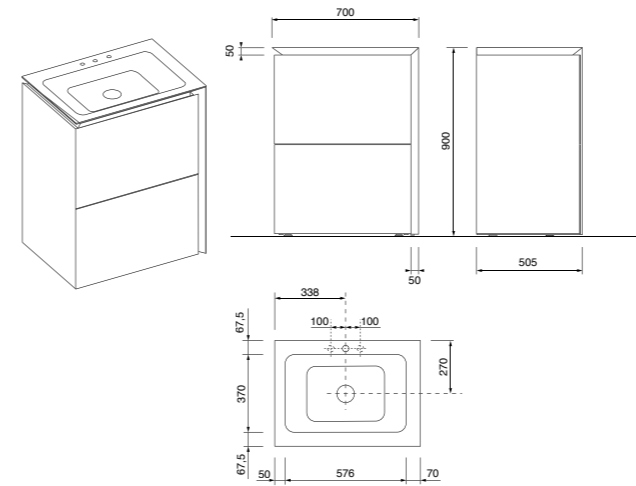

### B15C

/ Base monoblocco portallavabo con piano e spalla in Cristalplant®, con vasca lavamani integrata nel piano, senza troppopieno, completo di sifone cromato, piletta e tappo bianchi. Fianco base sottolavabo e frontali cassetto in finitura. H. 900 L. 700 prof. 505 mm. Versione solo con spalla destra. WRNWMB01.  
/ Monoblock unit for washbasin with top and side panel in Cristalplant®, with basin integrated in the top, without overflow, with chromium-plated siphon, waste drain and plug white. Side panel of the base unit for washbasin and drawer fronts in finish. H. 900 W. 700 D. 505 mm. Available version with side panel positioned on right only. WRNWMB01.

/ Base porte-lavabo avec plan lavabo et panneau vertical en Cristalplant®, Lavabo sans trop-plein, muni de siphon chromé, bonde et bouchon blancs. Côté et façades tiroir en finitions. H. 900 L. 700 prof. 505 mm. Seulement version avec panneau vertical droit. WRNWMB01.  
/ Blockunterschrank für Waschbecken mit Waschtischplatte und Seitenteil aus Cristalplant®, mit Handwaschbecken integriertem in Waschtischplatte, ohne Überlauf, mit verchromtem Siphon, Ablauf und Verschluss weiß. Unterschrank für Waschbecken mit Seite und Schubladenfronten in Ausführung. H. 900 B. 700 Tiefe 505 mm. Nur die Version mit Seitenteil rechts. WRNWMB01.  
/ Mueble bajo para lavabo con costado y frentes cajón en acabado. Encimera lavabo y panel trasero de Cristalplant®. Lavabo sin rebosadero, dotado de sifón cromado, válvula y tapones blancos. H. 900 L. 700 prof. 505 mm. Solo versión con panel trasero derecho. WRNWMB01.

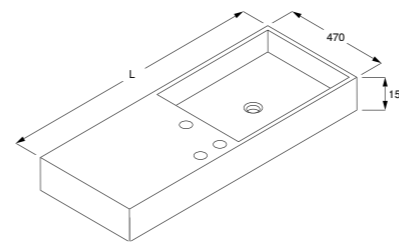

### Canale

/ Lavabo da appoggio H. 150 mm P. 470 mm in Cristalplant® bianco con troppopieno, completo di piletta e sifone cromato. Posizione vasca reversibile, dimensione vasca H. 100 L. 800 P. 436 mm. L. da 1200 a 1600 mm. WRCNAE01, da 1601 a 2000 mm. WRCNAE02, da 2001 a 2400 WRCNAE03. Lavabo sospeso monoblocco con vasca posizionabile a dx o sx, dimensione vasca H. 100 L. 800 P. 436 mm. L. da 1200 a 1600 mm. WRCNAD01 S-D, da 1601 a 2000 mm. WRCNAD02 S-D, da 2001 a 2400 mm. WRCNAD03 S-D.  
/ Washbasin for counter top mounting, H. 150 mm P. 470 mm. in white Cristalplant®, with overflow, equipped with waste-drain and chromium-plated siphon. Reversible basin: H. 100 W. 800 D. 436 mm. W. from 1200 to 1600 mm. WRCNAE01, from 1601 to 2000 mm. WRCNAE02, from 2001 to 2400 WRCNAE03. Suspended monoblock washbasin. Basin right/left: H. 100W. 800 D. 436 mm. W. from 1200 to 1600 mm. WRCNAD01 S-D, from 1601 to 2000 mm. WRCNAD02 S-D, from 2001 to 2400 mm. WRCNAD03 S-D.  
/ Lavabo en appui en Cristalplant® blanc, avec trop plein, y compris vidange et siphon universel, chromé pour lavabo. Position vasque réversible, dimension H. 100 L. 800 P. 436 mm. L. de 1200 à 1600 mm. WRCNAE01, de 1601 à 2000 mm. WRCNAE02, de 2001 à 2400 WRCNAE03. Lavabo suspendu en un seul bloc. Vasque à positionner à droite ou à gauche, dimensions H. 100, L. 800, 436 mm. De 1200 à 1600 mm. WRCNAD01 S-D, de 1601 à 2000 mm. WRCNAD02 S-D de 2001 à 2400 mm. WRCNAD03 S-D.

/ Aufsatz-Waschbecken, mit Überlauf, mit Ablauf und universalem verchromtem Siphon für Waschbecken. Position reversibles Becken, Ausmaße: H. 100, L. 800, T. 436 mm. B. von 1200 bis 1600 mm. WRCNAE01, von 1601 bis 2000 mm. WRCNAE02, von 2001 bis 2400 WRCNAE03. Blockwaschbecken aus Cristalplant®, mit Überlauf. Becken rechts oder links, Beckenausmaße H. 100, L. 800, T. 436 mm. B. von 1200 bis 1600 mm. WRCNAD01 S-D, von 1601 bis 2000 mm. WRCNAD02 S-D, von 2001 bis 2400 mm. WRCNAD03 S-D.  
/ Lavabo sobre encimera en Cristalplant®, con rebosadero. Posición cuba reversible / dimensiones L. 800 P. 436 H. 100. L. de 1200 a 1600 mm. WRCNAE01, de 1601 a 2000 mm. WRCNAE02, de 2001 a 2400 WRCNAE03. Lavabo suspendido monobloque en Cristalplant®, con rebosadero. Dimensiones cuba: L. 800 P. 436 H. 100 mm. Versiones: cuba a la izquierda (S) o a la derecha (D). L. de 1200 a 1600 mm. WRCNAD01 S-D, de 1601 a 2000 mm. WRCNAD02 S-D, de 2001 a 2400 mm. WRCNAD03 S-D.

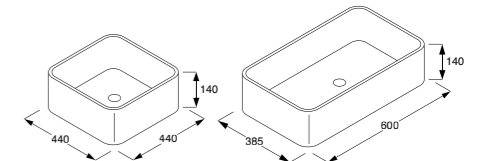

### Cathino

/ Lavabo da appoggio in Ceramilux® bianco, senza troppopieno, completo di piletta e sifone cromati. L. 440, P. 440, H. 140 mm. bianco lucido cod. WXCHAE01, bianco opaco cod. WXCHAE03 / L. 600, P. 385, H. 140 mm. bianco lucido cod. WXCHAE02, bianco opaco cod. WXCHAE04.  
/ Washbasin for counter top mounting in white Ceramilux®, without overflow, equipped with chromium-plated wastedrain and siphon. L. 440, P. 440, H. 140 mm. white gloss cod. WXCHAE01, white matt cod. WXCHAE03 / L. 600, P. 385, H. 140 mm. white gloss cod. WXCHAE02, white matt cod. WXCHAE04.  
/ Lavabo sur plan en Ceramilux® blanc, sans trop plein, avec bonde et siphon chromés. L. 440, P. 440, H. 140 mm. blanc brillant cod. WXCHAE01, blanc mat cod. WXCHAE03 / L. 600, P. 385, H. 140 mm. blanc brillant cod. WXCHAE02, blanc mat cod. WXCHAE04.  
/ Aufsatz-Waschbecken aus Ceramilux® weiß, ohne Überlauf, komplett mit Ablauf und verchromtem Siphon. L. 440, P. 440, H. 140 mm. weiß glänzend cod. WXCHAE01, weiß matt Cod. WXCHAE03 / L. 600, P. 385, H. 140 mm. weiß glänzend cod. WXCHAE02, weiß matt Cod. WXCHAE04.  
/ Lavabo sobre encimera en Ceramilux® blanco, sin rebosadero. L. 440, P. 440, H. 140 mm. blanco brillante cod. WXCHAE01, blanco mate cod. WXCHAE03 / L. 600, P. 385, H. 140 mm. blanco brillante cod. WXCHAE02, blanco mate cod. WXCHAE04.

## Lavabi Washbasins

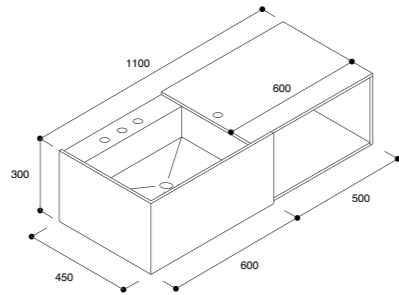
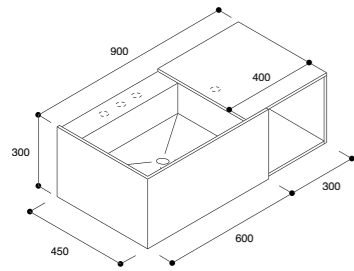

### Duec

/ Sistema modulare di contenitori a giorno in Corian® bianco o in PaperStone® nero ed elementi lavabo in Corian® bianco. Lavabo uso terminale con elemento a giorno uso terminale. L. 900, P. 450, H. 300 mm. WN2CMT01 S-D / L. 1100, P. 450, H. 300 mm. WN2CMT02 S-D.

/ Modular system composed of open-faced units in white Corian® or in black PaperStone® and washbasin elements in white Corian®. End-use washbasin with end-use open-faced unit. L. 900, P. 450, H. 300 mm. WN2CMT01 S-D / L. 1100, P. 450, H. 300 mm. WN2CMT02 S-D.

/ Système modulaire d'éléments ouverts en Corian® blanc ou en PaperStone® noir et éléments lavabo en Corian® blanc. Lavabo utilisation en extrémité avec élément ouvert utilisation en extrémité. L. 900, P. 450, H. 300 mm. WN2CMT01 S-D / L. 1100, P. 450, H. 300 mm. WN2CMT02 S-D.

/ Modulares System mit offenen Elementen aus Corian® weiß oder aus PaperStone® schwarz und Waschbeckenelementen aus Corian® weiß. Waschbecken als Abschlusselement mit offenem Abschlusselement. L. 900, P. 450, H. 300 mm. WN2CMT01 S-D / L. 1100, P. 450, H. 300 mm. WN2CMT02 S-D.

/ Sistema modular de muebles contenedores abierto en Corian® blanco o PaperStone® negro y elementos lavabo en Corian® blanco. Lavabo uso terminal con elemento abierto uso terminal. L. 900, P. 450, H. 300 mm. WN2CMT01 S-D / L. 1100, P. 450, H. 300 mm. WN2CMT02 S-D.

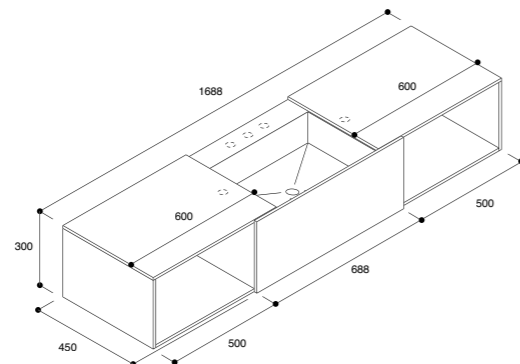
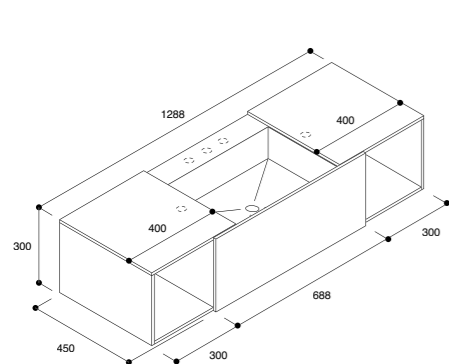

### Duec

/ Sistema modulare di contenitori a giorno in Corian® bianco o in PaperStone® nero ed elementi lavabo in Corian® bianco. Lavabo uso intermedio con doppio elemento a giorno uso terminale. L. 1288, P. 450, H. 300 mm. WN2CMM01 / L. 1688, P. 450, H. 300 mm. WN2CMM02.

/ Modular system composed of open-faced units in white Corian® or in black PaperStone® and washbasin elements in white Corian®. Middle-use washbasin with end-use double open-faced unit. L. 1288, P. 450, H. 300 mm. WN2CMM01 / L. 1688, P. 450, H. 300 mm. WN2CMM02.

/ Système modulaire d'éléments ouverts en Corian® blanc ou en PaperStone® noir et éléments lavabo en Corian® blanc. Lavabo utilisation intermédiaire avec double élément ouvert utilisation en extrémité. L. 1288, P. 450, H. 300 mm. WN2CMM01 / L. 1688, P. 450, H. 300 mm. WN2CMM02.

/ Modulares System mit offenen Elementen aus Corian® weiß oder aus PaperStone® schwarz und Waschbeckenelementen aus Corian® weiß. Waschbecken als Zwischenelement mit offenem Doppel-Abschlusselement. L. 1288, P. 450, H. 300 mm. WN2CMM01 / L. 1688, P. 450, H. 300 mm. WN2CMM02.

/ Sistema modular de muebles contenedores abierto en Corian® blanco o PaperStone® negro y elementos lavabo en Corian® blanco. Lavabo uso intermedio con elemento doble abierto uso terminal. L. 1288, P. 450, H. 300 mm. WN2CMM01 / L. 1688, P. 450, H. 300 mm. WN2CMM02.

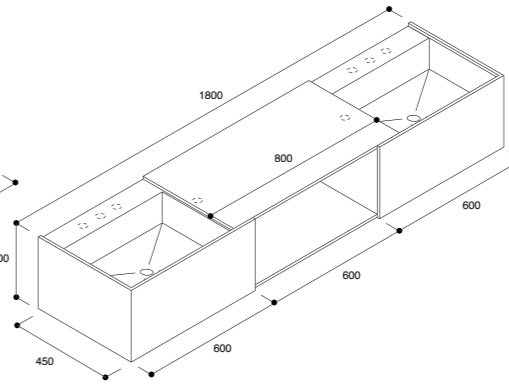
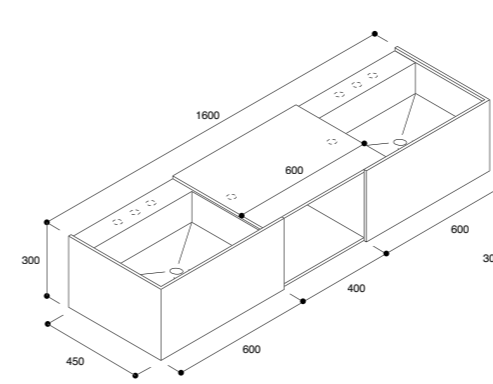

### Duec

/ Sistema modulare di contenitori a giorno in Corian® bianco o in PaperStone® nero ed elementi lavabo in Corian® bianco. Doppio lavabo uso terminale con elemento a giorno uso intermedio. L. 1600, P. 450, H. 300 mm. WN2CMT03 / L. 1800, P. 450, H. 300 mm. WN2CMT04.

/ Modular system composed of open-faced units in white Corian® or in black PaperStone® and washbasin elements in white Corian®. End-use double washbasin with middle-use open-faced unit. L. 1600, P. 450, H. 300 mm. WN2CMT03 / L. 1800, P. 450, H. 300 mm. WN2CMT04.

/ Système modulaire d'éléments ouverts en Corian® blanc ou en PaperStone® noir et éléments lavabo en Corian® blanc. Double lavabo utilisation en extrémité avec élément ouvert utilisation intermédiaire. L. 1600, P. 450, H. 300 mm. WN2CMT03 / L. 1800, P. 450, H. 300 mm. WN2CMT04.

/ Modulares System mit offenen Elementen aus Corian® weiß oder aus PaperStone® schwarz und Waschbeckenelementen aus Corian® weiß. Doppelbecken als Zwischenelement mit offenem Zwischenelement. L. 1600, P. 450, H. 300 mm. WN2CMT03 / L. 1800, P. 450, H. 300 mm. WN2CMT04.

/ Sistema modular de muebles contenedores abierto en Corian® blanco o PaperStone® negro y elementos lavabo en Corian® blanco. Lavabo doble uso terminal con elemento abierto uso intermedio. L. 1600, P. 450, H. 300 mm. WN2CMT03 / L. 1800, P. 450, H. 300 mm. WN2CMT04.

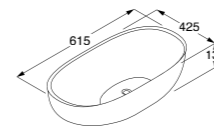
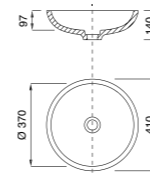

### Emisfero Stone

/ Lavabo da incasso in massello di marmo, senza troppopieno. Compatibile solo con piano in marmo/pietra/granito. Marmo bianco Carrara cod. WMEMAB01. Granito Nero Assoluto Zimbabwe cod. WMEMAB02. Pietra d'Avola cod. WMEMAB03. Pietra Crema d'Orcia cod. WMEMAB04.

/ Built-in washbasin in solid marble, without overflow. Compatible only with top in marble/stone/granite. White Carrara marble cod. WMEMAB01. Zimbabwe extra black granite cod. WMEMAB02. Pietra d'Avola stone cod. WMEMAB03. Pietra Crema d'Orcia stone cod. WMEMAB04.

/ Lavabo à encastrer en massif de marbre, sans trop-plein. Compatible seulement avec plans en marbre/pierre/granite. Marbre blanc Carrara cod. WMEMAB01. Granite Noir absolu Zimbabwe cod. WMEMAB02. Pierre d'Avola cod. WMEMAB03. Pierre Crema d'Orcia cod. WMEMAB04.

/ Einbauwaschbecken aus massivem Marmor, ohne Überlauf. Kompatibel nur mit Waschtischplatte aus Stein/ Marmor/ Granit. Marmor weiß Carrara Cod. WMEMAB01. Granit Tiefschwarz Zimbabwe Cod. WMEMAB02. Stein Pietra d'Avola Cod. WMEMAB03. Stein Pietra Crema d'Orcia Cod. WMEMAB04.

/ Lavabo para empotrado en mármol macizo, sin rebosadero. Compatible solo con encimera de mármol/piedra/granito. Mármol blanco Carrara cod. WMEMAB01. Granito Negro absoluto Zimbabwe cod. WMEMAB02. Pietra d'Avola cod. WMEMAB03. Pietra Crema d'Orcia cod. WMEMAB04.

### Fisher Island

/ Lavabo soprapiano in Cristalplant®, senza troppopieno. L. 615 P. 425 H. 138 mm. Versione tutto bianco cod. WRAFAE01. Versione bianco con rivestimento esterno in vernice grigio antracite cod. WSAFAE01.

/ Top-mounted washbasin in Cristalplant®, without overflow. L. 615 P. 425 H. 138 mm. Totally white cod. WRAFAE01. White + coating made of anthracite grey paint cod. WSAFAE01.

/ Lavabo sur plan en Cristalplant®, sans trop-plein. L. 615 P. 425 H. 138 mm. Tout blanc cod. WRAFAE01. Blanc + revêtement externe avec peinture gris anthracite cod. WSAFAE01.

/ Aufsatz-Waschbecken aus Cristalplant®, ohne Überlauf. L. 615 P. 425 H. 138 mm. Vollständig weiß cod. WRAFAE01. Weiß + Außenlackierung anthrazitgrau cod. WSAFAE01.

/ Lavabo sopra encimera en Cristalplant®, sin rebosadero. L. 615 P. 425 H. 138 mm. Versiones: todo blanco cod. WRAFAE01. Blanco + revestimiento exterior con pintura gris antracita cod. WSAFAE01.

## Lavabi Washbasins

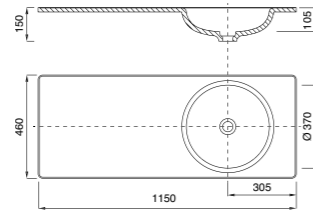
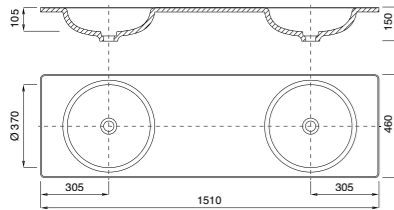

### Floe

/ Lavabo da incasso in Cristalplant® con piano integrato, senza troppopieno. L. 1150 P. 460 H. 20 mm. Cod. WRFEAF01 S-D. Lavabo da incasso doppio, L. 1510 P. 460 H. 20 mm. Cod. WRFEAF02.

/ Built-in washbasin in Cristalplant® with integrated top, without overflow L. 1150 P. 460 H. 20 mm. Cod. WRFEAF01 S-D. Double built-in washbasin, L. 1510 P. 460 H. 20 mm. Cod. WRFEAF02.

/ Lavabo à encastrer en Cristalplant® avec plan intégré, sans trop-plein. L. 1150 P. 460 H. 20 mm. Cod. WRFEAF01 S-D. Lavabo à encastrer double en Cristalplant®, L. 1510 P. 460 H. 20 mm. Cod. WRFEAF02.

/ Einbauwaschbecken aus Cristalplant® mit integrierter Platte, ohne Überlauf. L. 1150 P. 460 H. 20 mm. Cod. WRFEAF01 S-D. Doppel-Einbauwaschbecken, L. 1510 P. 460, H. 20 mm. Cod. WRFEAF02.

/ Lavabo para empotrado de Cristalplant® con encimera empotrada, sin rebosadero. L. 1150 P. 460 H. 20 mm. Cod. WRFEAF01 S-D. Lavabo doble para empotrado, L. 1510 P. 460 H. 20 mm. Cod. WRFEAF02.

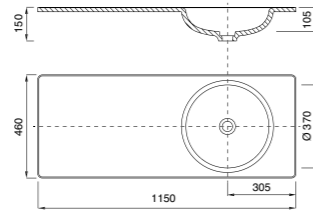
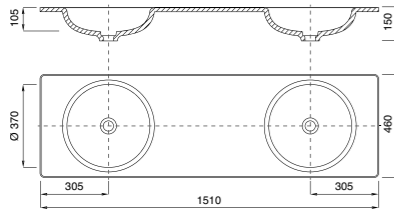

### Floe Stone

/ Lavabo da incasso con piano integrato, senza troppopieno. L. 1150, P. 460, H. 20 mm. Marmo bianco Carrara cod. WMFEAF01 S-D, Marmo Gris du Marais cod. WMFEAF02 S-D, Granito Black Cosmic cod. WMFEAF03 S-D, Granito Nero assoluto Zimbabwe cod. WMFEAF04 S-D, Pietra d'Avola cod. WMFEAF05 S-D. Lavabo da incasso doppio, L. 1510, P. 460, H. 20 mm. Marmo bianco Carrara cod. WMFEAF06, Marmo Gris du Marais cod. WMFEAF07, Granito Black Cosmic cod. WMFEAF08, Granito Nero assoluto Zimbabwe cod. WMFEAF09, Pietra d'Avola cod. WMFEAF10.

/ Built-in washbasin with integrated top, without overflow L. 1150, P. 460, H. 20 mm. White Carrara marble cod. WMFEAF01 S-D, Gris du Marais marble cod. WMFEAF02 S-D, Black Cosmic granite cod. WMFEAF03 S-D, Absolute black Zimbabwe granite cod. WMFEAF04 S-D, Pietra d'Avola stone cod. WMFEAF05 S-D. Double built-in washbasin, L. 1510, P. 460, H. 20 mm. White Carrara marble cod. WMFEAF06, Gris du Marais marble cod. WMFEAF07, Black Cosmic granite cod. WMFEAF08, Absolute black Zimbabwe granite cod. WMFEAF09, Pietra d'Avola stone cod. WMFEAF10.

/ Lavabo à encastrer avec plan intégré, sans trop-plein. L. 1150, P. 460, H. 20 mm. Marbre blanc Carrara cod. WMFEAF01 S-D, marbre Gris du Marais cod. WMFEAF02 S-D, Granite Black Cosmic cod. WMFEAF03 S-D, Granite Noir absolu Zimbabwe cod. WMFEAF04 S-D, Pierre d'Avola cod. WMFEAF05 S-D. Lavabo à encastrer double en Cristalplant®, L. 1510, P. 460, H. 20 mm. Marbre blanc Carrara cod. WMFEAF06, marbre Gris du Marais cod. WMFEAF07, Granite Black Cosmic cod. WMFEAF08, Granite Noir absolu Zimbabwe cod. WMFEAF09, Pierre d'Avola cod. WMFEAF10.

/ Einbauwaschbecken mit integrierter Platte, ohne Überlauf. L. 1150, P. 460, H. 20 mm. Marmor weiß Carrara Cod. WMFEAF01 S-D, Marmor Gris du Marais Cod. WMFEAF02 S-D, Granit Black Cosmic Cod. WMFEAF03 S-D, Granit Tiefschwarz Zimbabwe Cod. WMFEAF04 S-D, Stein Pietra D'Avola Cod. WMFEAF05 S-D. Doppel-Einbauwaschbecken, L. 1510, P. 460, H. 20 mm. Marmor weiß Carrara Cod. WMFEAF06, Marmor Gris du Marais Cod. WMFEAF07, Granit Black Cosmic Cod. WMFEAF08, Granit Tiefschwarz Zimbabwe Cod. WMFEAF09, Stein Pietra D'Avola Cod. WMFEAF10.

/ Lavabo para empotrado con encimera empotrada, sin rebosadero. L. 1150, P. 460, H. 20 mm. Mármol blanco Carrara Cod. WMFEAF01 S-D, Mármol Gris du Marais Cod. WMFEAF02 S-D, Granito Black Cosmic Cod. WMFEAF03 S-D, Granito Negro absoluto Zimbabwe Cod. WMFEAF04 S-D, Pietra D'Avola Cod. WMFEAF05 S-D. Lavabo doble para empotrado, L. 1510, P. 460, H. 20 mm. Mármol blanco Carrara Cod. WMFEAF06, Mármol Gris du Marais Cod. WMFEAF07, Granito Black Cosmic Cod. WMFEAF08, Granito Negro absoluto Zimbabwe Cod. WMFEAF09, Pietra D'Avola Cod. WMFEAF10.

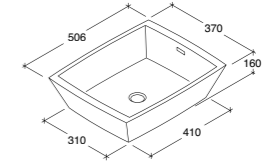
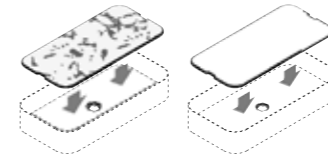
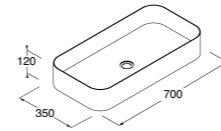

### Garden

/ Lavabo sopra piano in lamiera di acciaio inox AISI 304, finitura grigio PVD, senza troppopieno. Da completare con pianetto copri-scarico interno. L. 700 P. 350 H. 120 mm. Cod. WBGAAE01. Pianetto copri-scarico: pietra - marmo - granito cod. WMGAAV01; Corian® bianco cod. WNGAAV01. / Top-mounted washbasin in AISI 304 stainless steel sheet, grey PVD finish, without overflow. To be completed with drain-hole covering shelf. L. 700 P. 350 H. 120 mm. Cod. WBGAAE01. Drain-hole covering shelf: stone - marble - granite cod. WMGAAV01; white Corian® cod. WNGAAV01. / Lavabo sur plan en tôle acier inox AISI 304, finition gris PVD, sans trop-plein. À compléter avec petit plan couvre-écoulement interne. L. 700 P. 350 H. 120 mm. Cod. WBGAAE01. Petit plan couvre-écoulement interne: pierre - marbre - granite cod. WMGAAV01; Corian® blanc cod. WNGAAV01.

/ Aufsatz-Waschbecken in Edelstahlblech AISI 304, Ausführung grau PVD, ohne Überlauf. Zu ergänzen mit innerer Auslauf Abdeckplatte. L. 700 P. 350 H. 120 mm. Cod. WBGAAE01. Abdeckplatte für Ablauf: Stein - Marmor - Granit Cod. WMGAAV01; Corian® weiß Cod. WNGAAV01. / Lavabo sobre encimera en chapa de acero inoxidable AISI 304, acabado gris PVD, sin rebosadero. A completar con balda cubre-descarga interior. L. 700 P. 350 H. 120 mm. Cod. WBGAAE01. Tablero cubre-desagüe: piedra - mármol - granito cod. WMGAAV01; Corian® blanco cod. WNGAAV01.

### Gobi

/ Lavabo da piano piccolo, in Cristalplant®, con troppopieno, completo di piletta e sifone cromati. L. 506, P. 370, H. 160 mm. Versione tutto bianco WRGBAE01. Versione bianco con rivestimento esterno in vernice grigio antracite WSGBAE01. / Little washbasin for counter top mounting, in Cristalplant®, with overflow, provided with waste-drain and chromium-plated siphon. L. 506, P. 370, H. 160 mm. Totally white WRGBAE01. White + coating made of anthracite grey paint WSGBAE01.

/ Lavabo pour plan petit, en Cristalplant®, avec trop-plein, avec bonde et siphon chromés. L. 506, P. 370, H. 160 mm. Tout blanc WRGBAE01. Blanc + revêtement externe avec peinture gris anthracite WSGBAE01.

/ Kleines Waschbecken für Waschtischplatten, aus Cristalplant®, mit Überlauf, komplett mit Ablauf und verchromtem Siphon. L. 506, P. 370, H. 160 mm. Vollständig weiß WRGBAE01. Weiß + Außenlackierung anthrazitgrau WSGBAE01.

/ Lavabo apoyado en Cristalplant®, con rebosadero. L. 506, P. 370, H. 160 mm. Versiones: todo blanco WRGBAE01 / blanco + revestimiento exterior con pintura gris antracita WSGBAE01.

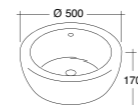
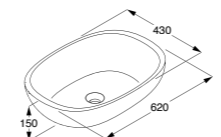

### Iceland

/ Lavabo da appoggio in Cristalplant® bianco, senza troppopieno, completo di scarico, tappo bianco e sifone. L. 620, P. 430, H. 150 mm. Versione tutto bianco WRICAE01. Versione bianco con rivestimento esterno in vernice grigio antracite WSICAE01.

/ Top-mounted washbasin in white Cristalplant®, without overflow, with white drain hole and siphon. L. 620, P. 430, H. 150 mm. Totally white WRICAE01. White + coating made of anthracite grey paint WSICAE01.

/ Lavabo d'appui en Cristalplant® blanc, sans trop-plein, muni d'écoulement, bouchon blanc et siphon. L. 620, P. 430, H. 150 mm. Tout blanc WRICAE01. Blanc + revêtement externe avec peinture gris anthracite WSICAE01.

/ Aufgebautes Waschbecken aus Cristalplant® weiß, ohne Überlauf, komplett mit Ablauf, Stopfen weiß und Siphon. L. 620, P. 430, H. 150 mm. Vollständig weiß WRICAE01. Weiß + Außenlackierung anthrazitgrau WSICAE01.

/ Lavabo apoyado en Cristalplant®, sin rebosadero. L. 620, P. 430, H. 150 mm. Versiones: todo blanco WRICAE01 / blanco + revestimiento exterior con pintura gris antracita WSICAE01.

### I Fiumi: Adda

/ Lavabo in Corian® da appoggio, con piletta, sifone e troppopieno cromato. L. 500, P. 500, H. 170 mm. WNADAE01. / Washbasin in Corian® for counter top mounting, with chromium-plated waste-drain, siphon and overflow. L. 500, P. 500, H. 170 mm. WNADAE01.

/ Lavabo en Corian® à poser, avec bonde, siphon et trop-plein chromés. L. 500, P. 500, H. 170 mm. WNADAE01.

/ Aufgebautes Waschbecken aus Corian®, mit verchromtem Ablauf, Siphon und Überlauf. L. 500, P. 500, H. 170 mm. WNADAE01.

/ Lavabo apoyado de Corian®, con rebosadero. L. 500, P. 500, H. 170 mm. WNADAE01.

### I Fiumi: Adige

/ Lavabo in massello di pietra, senza troppopieno. L. 500, P. 500, H. 170 mm. In pietra Serena WMAGAF04. / Washbasin in solid stone, without overflow. L. 500, P. 500, H. 170 mm. In Serena stone WMAGAF04.

/ Lavabo en massif de pierre, sans trop-plein. L. 500, P. 500, H. 170 mm. Pierre Serena WMAGAF04.

/ Waschbecken aus Massivstein, ohne Überlauf. L. 500, P. 500, H. 170 mm. Aus Serena-Stein, WMAGAF04.

/ Lavabo de piedra maciza, sin rebosadero. L. 500, P. 500, H. 170 mm. Piedra Serena WMAGAF04.

## Lavabi Washbasins

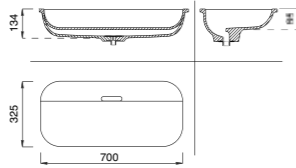
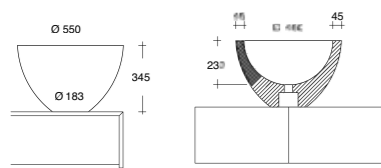

### I Fiumi: Piave

/ Lavabo in massello di pietra, senza troppopieno. L. 550, P. 550, H. 345 mm. In pietra Serena cod. WMPVAD02.  
/ Washbasin in solid stone, without overflow. L. 550, P. 550, H. 345 mm. In Serena stone cod. WMPVAD02.  
/ Lavabo en massif de pierre, sans trop-plein. L. 550, P. 550, H. 345 mm. Pierre Serena cod. WMPVAD02.  
/ Waschbecken aus Massivstein, ohne Überlauf. L. 550, P. 550, H. 345 mm. Aus Serena-Stein, WMPVAD02.  
/ Lavabo de piedra maciza, sin rebosadero. L. 550, P. 550, H. 345 mm. Piedra Serena cod. WMPVAD02.

### Kupa

/ Lavabo filopiano stampato in Cristalplant®, senza troppopieno. L. 700 P. 325 H. 134 mm. cod. WZKPAJ001.  
/ Moulded flush-mounted washbasin in Cristalplant®, without overflow. L. 700 P. 325 H. 134 mm. cod. WZKPAJ001.  
/ Lavabo moulé en encastrement affleurant, en Cristalplant®, sans trop-plein. L. 700 P. 325 H. 134 mm. cod. WZKPAJ001.  
/ Flächenbündiges Einbau-Waschbecken formgepresstes Cristalplant®, ohne Überlauf. L. 700 P. 325 H. 134 mm. Cod. WZKPAJ001.  
/ Lavabo empotrado a ras de la encimera, moldeado de Cristalplant®, sin rebosadero. L. 700 P. 325 H. 134 mm. cod. WZKPAJ001.

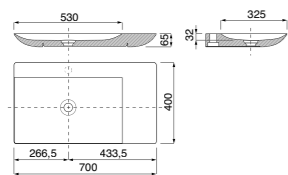

### L10

/ Lavabo in massello di marmo, in finitura satinata o levigata opaca, senza troppopieno, con spazio posteriore per eventuale installazione rubinetto monoforo, completo di piletta e sifone cromato. Utilizzabile in appoggio su piano o a parete con staffa cod. WILDSS01. L. 700 P. 400 H. 65 mm. Finitura satinata: Marmo bianco statuario WMLDAE01, marmo nero Marquinia WMLDAE02. Finitura levigata opaca: Marmo bianco Carrara WMLDAE03, Pietra d'Avola WMLDAE04.  
/ Washbasin in solid marble, satin or matt honed finish, without overflow. Equipped with rear space, if necessary, for single tap hole, waste-drain and chromium plated siphon. The basin can be used both supported on a cabinet and free standing, fixed to the wall with brackets cod. WILDSS01. L. 700P. 400 H. 65 mm. Satin finish: statuary white marble WMLDAE01, black Marquinia marble WMLDAE02. Matt honed finish: White Carrara marble WMLDAE03, Pietra d'Avola stone WMLDAE04.  
/ Lavabo en marbre massif, en finition satinée ou poncée mate, sans trop-plein, avec espace à l'arrière pour installation robinet monotrou, compris de bonde et siphon chromés. A' utiliser à poser sur plan ou au fixer au mur avec étrier code WILDSS01. L. 700 P. 400 H. 65 mm. Finition satinée : Marbre blanc statuario WMLDAE01, Marbre noir Marquinia WMLDAE02. Finition poncée mate : Marbre blanc Carrara WMLDAE03, Pierre d'Avola WMLDAE04.

/ Waschbecken aus Marmor, in Ausführung satiniert oder matt geschliffen, ohne Überlauf, komplett mit Ablauf und Siphon verchromt Dahinter kann eine Einloch-Einhandmischbatterie eingesetzt werden. Zum Aufbauen oder zur Wandbefestigung mit Trägerstruktur cod. WILDSS01. L. 700 P. 400 H. 65 mm. Satinierte Ausführung: Marmor weiß statuarisch WMLDAE01, Marmor schwarz Marquinia WMLDAE02. Matte geschliffene Ausführung: Marmor weiß Carrara WMLDAE03, Stein Pietra D'Avola WMLDAE04.  
/ Lavabo en mármol macizo, acabado satinado o pulido mate, sin rebosadero. Espacio trasero para posible agujero grifo. También suspendido con estructura de soporte WILDSS01. L. 700 P. 400 H. 65 mm. Acabado satinado: Blanco Statuario WMLDAE01. Negro Marquinia WMLDAE02. Acabado pulido mate: Mármol blanco Carrara WMLDAE03, Pietra d'Avola WMLDAE04.

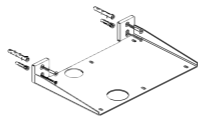

### L10

/ Struttura di sostegno per fissaggio a parete in inox satinato Cod. WILDSS01.  
/ Supporting structure for wall assembly in satin stainless steel. Cod. WILDSS01.  
/ Structure de support pour fixation murale, en inox satinée. Cod. WILDSS01.  
/ Trägerstruktur für Wandbefestigung aus Edelstahl satiniert Cod. WILDSS01.  
/ Estructura de soporte para fijación a pared in acero inoxidable satinado. Cod. WILDSS01.

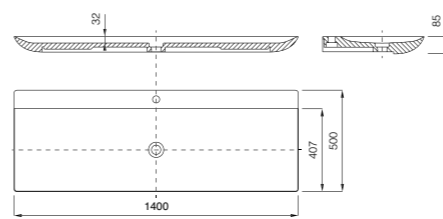

### L14

/ Lavabo da parete in massello di marmo, senza troppopieno. Finitura levigata opaca. L. 1400 P. 500 H. 85 mm. Marmo bianco Carrara cod. WMLQAD01; in pietra d'Avola cod. WMLQAD02.  
/ Wall washbasin in solid marble, without overflow. Matt honed finish. L. 1400 P. 500 H. 85 mm. In White Carrara marble cod. WMLQAD01, Pietra d'Avola stone cod. WMLQAD02.  
/ Lavabo murale en massif de marbre, sans trop-plein. Finition poncée mate. L. 1400 P. 500 H. 85 mm. Marbre blanc Carrara cod. WMLQAD01, Pierre d'Avola cod. WMLQAD02.  
/ Wand-Waschbecken aus massivem Marmor, ohne Überlauf. Matte geschliffene Ausführung. L. 1400 P. 500 H. 85 mm. Marmor weiß Carrara cod. WMLQAD01, Stein Pietra D'Avola cod. WMLQAD02.  
/ Lavabo de pared en mármol macizo, sin rebosadero. Acabado pulido mate. L. 1400 P. 500 H. 85 mm. Mármol blanco Carrara cod. WMLQAD01, Pietra d'Avola cod. WMLQAD02.

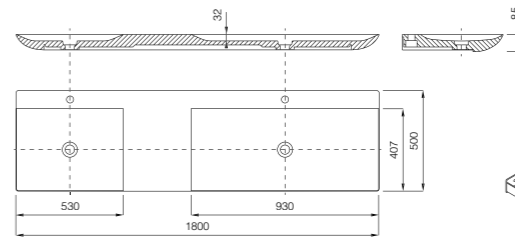

### L18

/ Lavabo da parete doppio in massello di marmo, senza troppopieno. Finitura satinata. L. 1800, P. 500, H. 85 mm. Marmo bianco Carrara cod. WMLCAD01, in pietra d'Avola cod. WMLCAD02.  
/ Double wall washbasin in solid marble, without overflow. Satin finish. L. 1800, P. 500, H. 85 mm. In White Carrara marble cod. WMLCAD01, Pietra d'Avola stone cod. WMLCAD02.  
/ Lavabo murale double en marbre massif, sans trop-plein. Finition satinée. L. 1800, P. 500, H. 85 mm. Marbre blanc Carrara cod. WMLCAD01, Pierre d'Avola cod. WMLCAD02.  
/ Wand-Doppelwaschbecken aus massivem Marmor, ohne Überlauf. Satinierte Ausführung. L. 1800, P. 500, H. 85 mm. Marmor weiß Carrara cod. WMLCAD01, Stein Pietra D'Avola cod. WMLCAD02.  
/ Lavabo de pared doble de mármol macizo, sin rebosadero. Acabado satinado. L. 1800, P. 500, H. 85 mm. Mármol blanco Carrara cod. WMLCAD01, Pietra d'Avola cod. WMLCAD02.

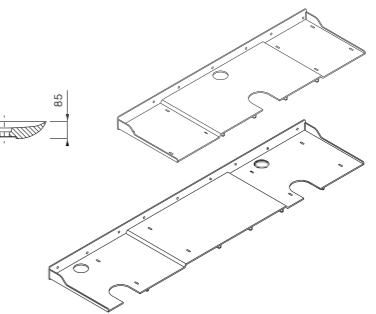

/ Struttura di sostegno per fissaggio a parete in inox verniciato bianco opaco o nero opaco. Per L14 cod. WILQSS01, per L18 cod. WILCSS01.  
/ Supporting structure for wall assembly in steel, matt white or matt black painted. For L14 cod. WILQSS01, for L18 cod. WILCSS01.  
/ Structure de support pour fixation murale, en inox peint blanc mat ou noir mat. Pour L14 cod. WILQSS01, pour L18 cod. WILCSS01.  
/ Trägerstruktur für Wandbefestigung aus Edelstahl matt weiß oder mattschwarz lackiert. Für L14 cod. WILQSS01, für L18 cod. WILCSS01.  
/ Estructura de soporte para fijación a pared in acero inoxidable pintado blanco mate o negro mate. Por L14 cod. WILQSS01, por L18 cod. WILCSS01.

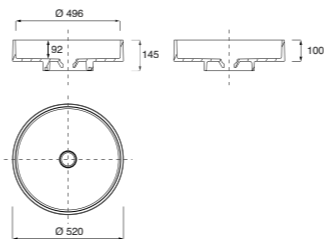

### Lotus

/ Lavabo d'appoggio o sospeso in Cristalplant® bianco, senza troppopieno. L. 520, P. 520, H. 145 mm. WRLSAE01. Sostegno per lavabo in lamiera acciaio inox per fissaggio a parete. WILSSS01.  
/ Top-mounted or suspended washbasin in white Cristalplant®, without overflow. L. 520, P. 520, H. 145 mm. WRLSAE01. Supporting structure for washbasin in stainless steel sheet for wall assembly. WILSSS01.  
/ Lavabo d'appui ou suspendu en Cristalplant® blanc, sans trop-plein. L. 520, P. 520, H. 145 mm. WRLSAE01. Support pour lavabo en tôle acier inox pour fixation murale. WILSSS01.

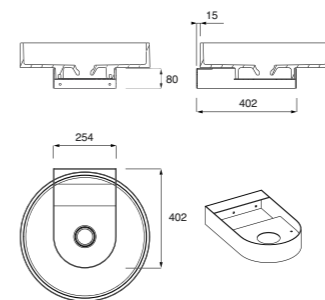

/ Aufgebautes oder wandbefestigtes Waschbecken aus Cristalplant® weiß, ohne Überlauf. L. 520, P. 520, H. 145 mm. WRLSAE01. Träger für Waschbecken aus Edelstahlblech für Wandbefestigung. WILSSS01.  
/ Lavabo apoyado o suspendido en Cristalplant® blanco, sin rebosadero. L. 520, P. 520, H. 145 mm. WRLSAE01. Soporte para lavabo de chapa acero inoxidable para fijación a pared. WILSSS01.

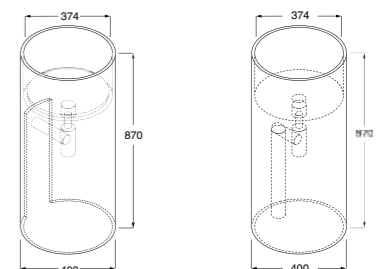

### Phc

Lavabo a colonna in Corian® bianco Ø 400 H. 900 mm, senza troppopieno, completo di vassoio copriscarico. A parete cod. WRPHAG01. In Cristalplant® bianco a parete (H. 870 mm), cod. WRPHAG01, bianco+grigio Soft Touch cod. WSPHAG01. In Cristalplant® bianco+grigio Soft Touch stanza (H. 870 mm), cod. WRPHAG02, bianco+grigio Soft Touch cod. WSPHAG02.  
/ Free-standing washbasin in white Corian® Ø 400 H. 900 mm, without overflow, provided with covering-plate for outlet. Wall-mounted version, cod. WNPHAG01. In white Cristalplant®, wall-mounted version (H. 870 mm), cod. WRPHAG01, white+Soft Touch grey cod. WSPHAG01. In white Cristalplant®, free-standing (H. 870 mm), cod. WRPHAG02, white+Soft Touch grey cod. WSPHAG02.  
/ Lavabo à colonne en Corian® blanc, sans trop plein, avec plateau couvre vidage. Mural cod. WNPHAG01. En Cristalplant® blanc, mural (H. 870 mm), cod. WRPHAG01, blanc + gris Soft Touch cod. WSPHAG01. En Cristalplant® blanc, au centre de la pièce (H. 870 mm), cod. WRPHAG02, blanc + gris Soft Touch cod. WSPHAG02.  
/ Waschbecken in Säulenform aus Corian® weiß Ø 400, H. 900 mm, ohne Überlauf, Deckel bedeckt den Abfluss. Wandbefestigt, WNPHAG01. Aus Cristalplant® weiß Wandbefestigt (H. 870 mm) WRPHAG01, Weiß + grau Soft Touch, WSPHAG01. Aus Cristalplant® weiß, freistehend (H. 870 mm), WRPHAG02, Weiß + grau Soft Touch, WSPHAG02.  
/ Lavabo de columna, de Corian®, sin rebosadero. Ø 400 H. 900 mm. Bandeja cubre-desagüe. De pared, cod. WNPHAG01. De Cristalplant® blanco, de pared (H. 870 mm.), cod. WRPHAG01, blanco+gris Soft Touch cod. WSPHAG01. De Cristalplant® blanco, en el centro del cuarto (H. 870 mm), cod. WRPHAG02, blanco+gris Soft Touch cod. WSPHAG02.



## Lavabi Washbasins

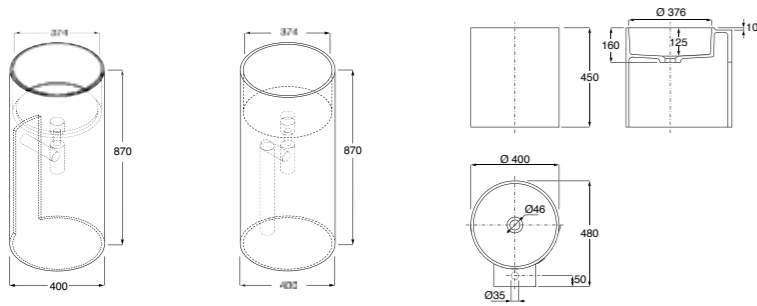

### Ph Stone

/ Lavabo a colonna in pietra (marmo bianco Carrara / pietra Serena / marmo Emperador Dark) senza troppopieno, Ø 400 H. 870 mm. A parete cod. WMPHAG01. A centro stanza cod. WMPHAG02.

/ Free-standing washbasin in stone (marble white Carrara / Serena stone / marble Emperador Dark) without overflow, Ø 400 H. 870 mm. Wall-mounted version cod. WMPHAG01. Free-standing version cod. WMPHAG02.

/ Lavabo à colonnes en pierre (marbre blanc Carrara / pierre Serena / marbre Emperador Dark) sans trop plein, Ø 400 H. 870 mm. Mural cod. WMPHAG01. Au centre de la pièce cod. WMPHAG02.

/ Waschbecken in Säulenform aus Stein (weiß Carrara Marmor / Stein Serena / Marmor Emperador Dark) ohne Überlauf, Ø 400 H. 870 mm. Wandbefestigt Cod. WMPHAG01. Freistehend Cod. WMPHAG02.

/ Lavabo de columna de piedra (mármol blanco Carrara / piedra Serena / mármol Emperador Dark), sin rebosadero. Ø 400 H. 870 mm. De pared cod. WMPHAG01. En el centro del cuarto cod. WMPHAG02.

### Phw Ceramilux

/ Lavabo in Ceramilux® bianco, senza troppopieno, H. 450 mm, Ø 400 mm, completo di piletta e sifone cromato. Bianco lucido cod. WXPFAA01, bianco opaco cod. WXPFAA03.

/ Washbasin in white Ceramilux®, without overflow, H. 450 mm, Ø 400 mm, provided with waste-drain and chromium plated siphon. White gloss cod. WXPFAA01, white matt cod. WXPFAA03.

/ Lavabo en Ceramilux® blanc, sans trop-plein, H. 450 mm, Ø 400 mm, avec bonde et siphon chromés. Blanc brillant cod. WXPFAA01, blanc mat cod. WXPFAA03.

/ Waschbecken aus Ceramilux® weiß, ohne Überlauf, H. 450 mm, Ø 400 mm, komplett mit verchromtem Ablauf und Siphon. Weiß glänzend Cod. WXPFAA01, weiß matt Cod. WXPFAA03.

/ Lavabo en Ceramilux®, sin rebosadero. H. 450 mm, Ø 400 mm. Blanco brillante cod. WXPFAA01, blanco mate cod. WXPFAA03.

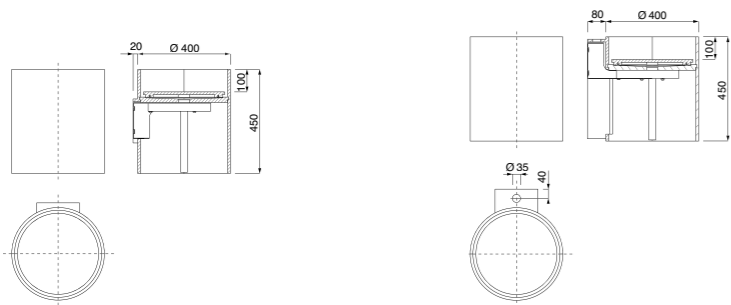

### Phw

/ Lavabo in Corian® bianco, senza troppopieno, sp. 12 mm, H. 450 mm, Ø 400 mm, completo di piletta e sifone cromato, vassoio copriscarico e staffa di sostegno in inox. Rubinetto installabile posteriormente o a parete. Predisposto per rubinetto monoforo WNPFAA02. Predisposto senza rubinetto WNPFAA01.

/ Washbasin in white Corian®, without overflow, 12 mm. thick, H. 450 mm, Ø 400 mm, provided with waste-drain and chromium-plated siphon, covering-plate for outlet and load-bearing bracket in stainless steel. Possibility of installing the tap either to the rear of the basin or directly on to the wall. Arranged for single tap WNPFAA02. Arranged without tap WNPFAA01.

/ Lavabo en Corian® blanc, sans trop-plein, ép. 12 mm, H. 450 mm, Ø 400 mm, avec bonde et siphon chromés, plateau couvre vidange et étrier de support en acier. Robinet à installer à l'arrière ou mural. Prêdisposé pour robinet monotrou WNPFAA02. Prêdisposé sans robinet WNPFAA01.

/ Waschbecken aus Corian® weiß, ohne Überlauf, 12 mm. stark, H. 450 mm, Ø 400 mm, komplett mit verchromtem Ablauf und Siphon, Deckel bedeckt den Abfluß und Halterungsstruktur aus Edelstahl. Die Armatur kann aus der Wand kommen oder hinter dem Waschbecken positioniert werden. Mit 1 Armaturbohrung WNPFAA02. Ohne Armaturbohrung WNPFAA01.

/ Lavabo en Corian®, sin rebosadero. H. 450 mm, Ø 400 mm. Bandeja cubre-desagüe en Corian® y estríbo de soporte inoxidable. Sin encimera y agujero para grifo WNPFAA02. Con encimera y 1 agujero para grifo WNPFAA01.

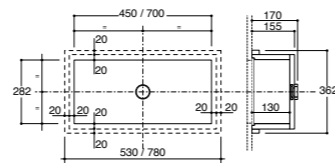

### Pietra

/ Lavabo sottopiano in pietra, marmo, granito o compositi. Completo di piletta con tappo nella stessa finitura. Senza troppopieno, scarico libero. L. 450 P. 282 H. 130 mm. WAPTAB01. L. 700 P. 282 H. 130 mm. WAPTAB02.

/ Under-mounted washbasin in stone, marble, granite or composites. Equipped with waste drain with plug in same finish. Without overflow, waste free flow. L. 450 P. 282 H. 130 mm. WAPTAB01. L. 700 P. 282 H. 130 mm. WAPTAB02.

/ Lavabo sous plan en pierre, marbre, granite, composites. Muni de bonde avec bouchon en pierre, marbre, granite ou pierre composite. Sans trop-plein, écoulement libre. L. 450 P. 282 H. 130 mm. WAPTAB01. L. 700 P. 282 H. 130 mm. WAPTAB02.

/ Unterbau-Waschbecken aus Stein, Marmor, Granit, Agglomerat. Mit Auslauf und Kappe in selbe Ausführung. Ohne Überlauf, freier Auslauf. L. 450 P. 282 H. 130 mm. WAPTAB01. L. 700 P. 282 H. 130 mm. WAPTAB02.

/ Lavabo bajo encimera de piedra, mármol, granito, compuestos. Dotado de válvula con tapón de piedra, mármol, granito o piedra artificial. Sin rebosadero, desagüe libre. L. 450 P. 282 H. 130 mm. WAPTAB01. L. 700 P. 282 H. 130 mm. WAPTAB02.

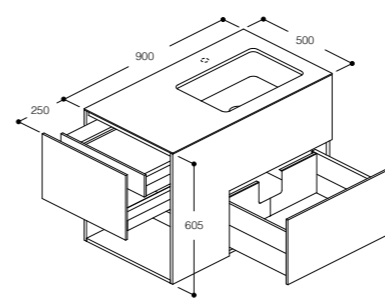

### Quadtwo

/ Base portalavabo in Silcover, nei colori di gamma Boffi. Piano in Cristalplant® bianco, spessore a vista 5 mm. (spessore totale 15 mm). Lavabo integrato Universal piccolo WRUNAB03. L. 900 H. 605 prof. 500 mm. WRQTMB01 S-D.

/ Base unit for washbasin in Silcover, colours of Boffi range. Top in white Cristalplant®, visible thickness: 5 mm. (total thickness: 15 mm). Integrated washbasin: Universal small WRUNAB03. L. 900 H. 605 d. 500 mm. WRQTMB01 S-D.

/ Base porte-lavabo en Silcover, dans les couleurs de la gamme Boffi. Plan en Cristalplant® blanc, épaisseur apparente 5 mm. (épaisseur totale 15 mm). Lavabo intégré Universal petit WRUNAB03. L. 900 H. 605 P. 500 mm. WRQTMB01 S-D.

/ Unterschrank für Waschbecken aus Silcover, in den Musterfarben Boffi. Waschtischplatte aus Cristalplant® weiß, sichtbare Stärke 5 mm. (Gesamtstärke 15 mm). Kleines integriertes Waschbecken Universal WRUNAB03. L. 900 H. 605 P. 500 mm. WRQTMB01 S-D.

/ Mueble bajo para lavabo en Silcover, en los colores de gama Boffi. Encimera en Cristalplant® blanco, espesor a la vista 5 mm. (espesor total 15 mm). Lavabo integrado Universal pequeño WRUNAB03. L. 900 H. 605 P. 500 mm. WRQTMB01 S-D.

/ Lavabo a parete in Silcover, nei colori di gamma Boffi. Piano in Cristalplant® bianco, spessore a vista 5 mm. (spessore totale 15 mm). Lavabo integrato Universal grande WRUNAB03. L. 900 H. 605 prof. 500 mm. WRQTMB01 S-D.

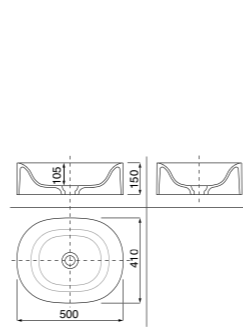

### Sabbia 3

/ Lavabo da appoggio in Cristalplant® color bianco, senza troppopieno. L. 500 P. 410 H. 150 mm. Versione tutto bianco WRSBAC01. Versione bianco con rivestimento esterno in vernice grigio antracite WSSBAC01.

/ Top-mounted washbasin in white Cristalplant®, without overflow. L. 500 P. 410 H. 150 mm. Totally white WRSBAC01. White + coating made of anthracite grey paint WSSBAC01.

/ Lavabo d'appui en Cristalplant® blanc, sans trop-plein. L. 500 P. 410 H. 150 mm. Tout blanc WRSBAC01. Blanc + revêtement externe avec peinture gris anthracite WSSBAC01.

/ Aufgebautes Waschbecken aus Cristalplant® weiß, ohne Überlauf. L. 500 P. 410 H. 150 mm. Vollständig weiß WRSBAC01. Weiß + Außenlackierung anthrazitgrau WSSBAC01.

/ Lavabo apoyado en Cristalplant®, sin rebosadero. L. 500 P. 410 H. 150 mm. Versiones: todo blanco WRSBAC01. Blanco + revestimiento exterior con pintura gris antracita WSSBAC01.

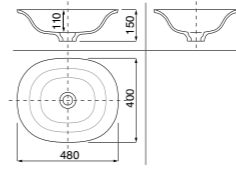

### Sabbia 1

/ Lavabo filopiano in Cristalplant® color bianco, senza troppopieno. Da utilizzare solo con piani in Cristalplant® sp. 15 mm. Lavabo e lavorazione di stampaggio inclusi. L. 480 P. 400 H. 105 mm. WRSBAB01.

/ Flush-mounted washbasin in white Cristalplant®, without overflow. To be used only with tops in Cristalplant® th. 15 mm. The washbasin and the moulding process are included. L. 480 P. 400 H. 105 mm. WRSBAB01.

/ Lavabo affleurant en Cristalplant®, sans trop-plein. Compatible seulement avec plans en Cristalplant® épaisseur 15 mm. Prix comprenant lavabo et usinage pour moulage. L. 480 P. 400 H. 105 mm. WRSBAB01.

/ Flächenbundiges Waschbecken aus Cristalplant®, ohne Überlauf. Nur kompatibel mit Waschtischplatten aus Cristalplant® Stärke 15 mm. Waschbecken und Pressform-Bearbeitung inkl. L. 480, P. 400, H. 105 mm. WRSBAB01.

/ Lavabo a ras de la encimera en Cristalplant®, sin rebosadero. Compatible solo con encimeras en Cristalplant® de 15 mm. de espesor. El precio incluye lavabo y proceso de moldeo. L. 480 P. 400 H. 105 mm. WRSBAB01.

/ Lavabo a parete in Cristalplant® color bianco, senza troppopieno. Da utilizzare solo con piani in Cristalplant® sp. 15 mm. Lavabo e lavorazione di stampaggio inclusi. L. 600 P. 400 H. 105 mm. WRSBAB02.

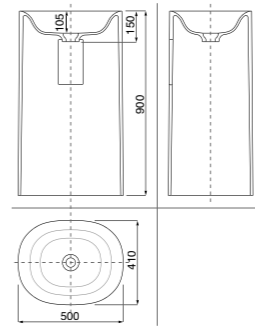

### Sabbia 4

/ Lavabo in Cristalplant® color bianco, senza troppopieno. L. 500 P. 410 H. 900 mm. Versione a parete WRSBAG02. Versione bianco con rivestimento esterno in vernice grigio antracite WSSBAG02.

/ Washbasin in white Cristalplant®, without overflow. L. 500 P. 410 H. 900 mm. Wall-mounted version WRSBAG02. White + coating made of anthracite grey paint WSSBAG02.

/ Lavabo en Cristalplant® blanc sans trop plein. L. 500 P. 410 H. 900 mm. Installation murale WRSBAG02. Blanc + revêtement externe avec peinture gris anthracite WSSBAG02.

/ Aufgebautes Waschbecken aus weißem Cristalplant®, ohne Überlauf. L. 500 P. 410 H. 900 mm. Wandversion WRSBAG02. Weiß + Außenlackierung anthrazitgrau WSSBAG02.

/ Lavabo en Cristalplant®, sin rebosadero. L. 500 P. 410 H. 900 mm. De pared WRSBAG02. Blanco + revestimiento exterior con pintura gris antracita WSSBAG02.

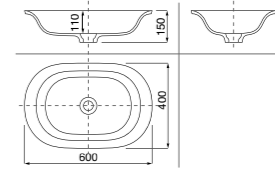

### Sabbia 2

/ Lavabo filopiano in Cristalplant® color bianco, senza troppopieno. Da utilizzare solo con piani in Cristalplant® sp. 15 mm. Lavabo e lavorazione di stampaggio inclusi. L. 600 P. 400 H. 105 mm. WRSBAB02.

/ Flush-mounted washbasin in white Cristalplant®, without overflow. To be used only with tops in Cristalplant® th. 15 mm. The washbasin and the moulding process are included. L. 600 P. 400 H. 105 mm. WRSBAB02.

/ Lavabo affleurant en Cristalplant®, sans trop-plein. Compatible seulement avec plans en Cristalplant® épaisseur 15 mm. Prix comprenant lavabo et usinage pour moulage. L. 600 P. 400 H. 105 mm. WRSBAB02.

/ Flächenbundiges Waschbecken aus Cristalplant®, ohne Überlauf. Nur kompatibel mit Waschtischplatten aus Cristalplant® Stärke 15 mm. Waschbecken und Pressform-Bearbeitung inkl. L. 600 P. 400 H. 105 mm. WRSBAB02.

/ Lavabo a ras de la encimera en Cristalplant®, sin rebosadero. Compatible solo con encimeras en Cristalplant® de 15 mm. de espesor. El precio incluye lavabo y proceso de moldeo. L. 600 P. 400 H. 105 mm. WRSBAB02.

/ Lavabo a parete in Cristalplant® color bianco, senza troppopieno. Da utilizzare solo con piani in Cristalplant® sp. 15 mm. Lavabo e lavorazione di stampaggio inclusi. L. 600 P. 400 H. 105 mm. WRSBAB02.

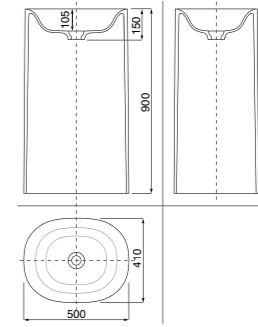

### Sabbia 5

/ Lavabo in Cristalplant® color bianco, senza troppopieno. L. 500 P. 410 H. 900 mm. Versione centro stanza. Versione tutto bianco WRSBAG01. Versione bianco con rivestimento esterno in vernice grigio antracite WSSBAG01.

/ Washbasin in white Cristalplant®, without overflow. L. 500 P. 410 H. 900 mm. Freestanding version. Totally white WRSBAG01. White + coating made of anthracite grey paint WSSBAG01.

/ Lavabo en Cristalplant® blanc sans trop plein. L. 500 P. 410 H. 900 mm. Installation au centre de la pièce. Tout blanc WRSBAG01. Blanc + revêtement externe avec peinture gris anthracite WSSBAG01.

/ Waschbecken aus weißem Cristalplant®, ohne Überlauf. L. 500 P. 410 H. 900 mm. Freistehendes Version. Vollständig weiß WRSBAG01. Weiß + Außenlackierung anthrazitgrau WSSBAG01.

/ Lavabo en Cristalplant®, sin rebosadero. L. 500 P. 410 H. 900 mm. Instalación en el centro del cuarto. Versiones: todo blanco WRSBAG01 / blanco + revestimiento exterior con pintura gris antracita WSSBAG01.

## Lavabi Washbasins

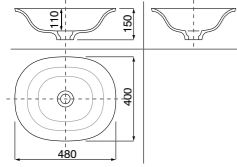

### Sabbia 6

/ Lavabo filopiano termoformato in Corian® color bianco, senza troppopieno. Da utilizzare solo con piani in Corian® Pianura, Flyer e Fiumi ST. Lavabo e lavorazione di termoformatura inclusi. L. 480 P. 400 H. 105 mm. ZTRBK01.

/ Flush-mounted thermoformed washbasin in white Corian®, without overflow. To be used only with tops in Corian® Pianura, Flyer and Fiumi ST. The washbasin and the thermoforming process are included. L. 480 P. 400 H. 105 mm. ZTRBK01.

/ Lavabo affleurant thermoformé en Corian®, sans trop-plein. Compatible seulement avec plans en Corian® Pianura, Flyer et Fiumi ST. Prix comprenant lavabo et pour thermoformage. L. 480 P. 400 H. 105 mm. ZTRBK01.

/ Flächenbundiges thermogeformtes Waschbecken aus Corian®, ohne Überlauf. Nur kompatibel mit Waschtischplatten aus Corian® Pianura, Flyer und Fiumi ST. Waschbecken und Thermo-Bearbeitung inkl. L. 480 P. 400 H. 105 mm. ZTRBK01.

/ Lavabo termoformato a ras de la encimera en Corian®, sin rebosadero. Compatible solo con encimeras en Corian® Pianura, Flyer e Fiumi ST. El precio incluye lavabo y proceso de termoformato. L. 480 P. 400 H. 105 mm. ZTRBK01.

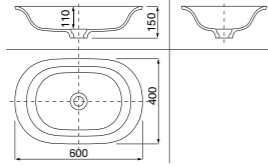

### Sabbia 7

/ Lavabo filopiano termoformato in Corian® color bianco, senza troppopieno. Da utilizzare solo con piani in Corian® Pianura, Flyer e Fiumi ST. Lavabo e lavorazione di termoformatura inclusi. L. 600 P. 400 H. 105 mm. ZTRBK02.

/ Flush-mounted thermoformed washbasin in white Corian®, without overflow. To be used only with tops in Corian® Pianura, Flyer and Fiumi ST. The washbasin and the thermoforming process are included. L. 600 P. 400 H. 105 mm. ZTRBK02.

/ Lavabo affleurant thermoformé en Corian®, sans trop-plein. Compatible seulement avec plans en Corian® Pianura, Flyer et Fiumi ST. Prix comprenant lavabo et pour thermoformage. L. 600 P. 400 H. 105 mm. ZTRBK02.

/ Flächenbundiges thermogeformtes Waschbecken aus Corian®, ohne Überlauf. Nur kompatibel mit Waschtischplatten aus Corian® Pianura, Flyer und Fiumi ST. Waschbecken und Thermo-Bearbeitung inkl. L. 600 P. 400 H. 105 mm. ZTRBK02.

/ Lavabo termoformato a ras de la encimera en Corian®, sin rebosadero. Compatible solo con encimeras en Corian® Pianura, Flyer e Fiumi ST. El precio incluye lavabo y proceso de termoformato. L. 600 P. 400 H. 105 mm. ZTRBK02.

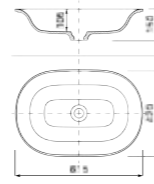

### Sabbia Btm

/ Lavabo soprapiano da incasso in Cristalplant®, senza troppopieno. L. 615 P. 420 H. 150 mm, cod. WRSBAF01.

/ Built-in, top-mounted washbasin in Cristalplant®, without overflow. L. 615 P. 420 H. 150 mm, cod. WRSBAF01.

/ Lavabo sur plan en Cristalplant®, sans trop plein. L. 615 P. 420 H. 150 mm, cod. WRSBAF01.

/ Aufsatz-Waschbecken aus Cristalplant®, ohne Überlauf. L. 615 P. 420 H. 150 mm, cod. WRSBAF01.

/ Lavabo sobre encimera de Cristalplant®, sin rebosadero. L. 615 P. 420 H. 150 mm, cod. WRSBAF01.

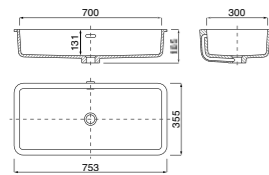

### Universal Grande

/ Lavabo sottopiano in Cristalplant®, con troppopieno, completo di piletta e sifone cromato. L. 700 P. 300 H. 131 mm. WRUNAB02.

/ Under-mounted washbasin in Cristalplant®, with overflow, provided with chromium-plated waste-drain and siphon. L. 700 P. 300 H. 131 mm. WRUNAB02.

/ Lavabo sous-plan en Cristalplant®, avec trop-plein, avec bonde et siphon chromés. L. 700 P. 300 H. 131 mm. WRUNAB02.

/ Untergebautes Waschbecken aus Cristalplant®, mit Überlauf, komplett mit verchromtem Ablauf und Siphon. L. 700 P. 300 H. 131 mm. WRUNAB02.

/ Lavabo en Cristalplant®, con rebosadero, válvula + sifón cromo. L. 700 P. 300 H. 131 mm. WRUNAB02.

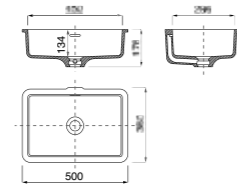

### Universal Piccolo

/ Lavabo sottopiano in Cristalplant®, con troppopieno, completo di piletta e sifone cromato. L. 450 P. 296 H. 133 mm. WRUNAB03.

/ Under-mounted washbasin in Cristalplant®, with overflow, provided with chromium-plated waste-drain and siphon. L. 450 P. 296 H. 133 mm. WRUNAB03.

/ Lavabo sous-plan en Cristalplant®, avec trop-plein, avec bonde et siphon chromés. L. 450 P. 296 H. 133 mm. WRUNAB03.

/ Untergebautes Waschbecken aus Cristalplant®, mit Überlauf, komplett mit verchromtem Ablauf und Siphon. L. 450 P. 296 H. 133 mm. WRUNAB03.

/ Lavabo en Cristalplant®, con rebosadero, válvula + sifón cromo. L. 450 P. 296 H. 133 mm. WRUNAB03.

## Vasche Bathtubs

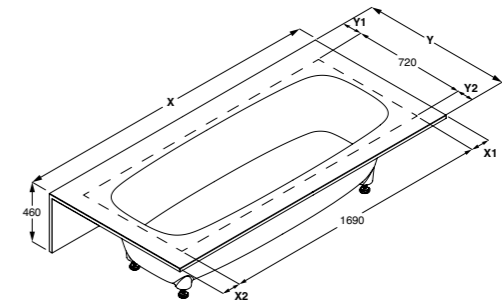
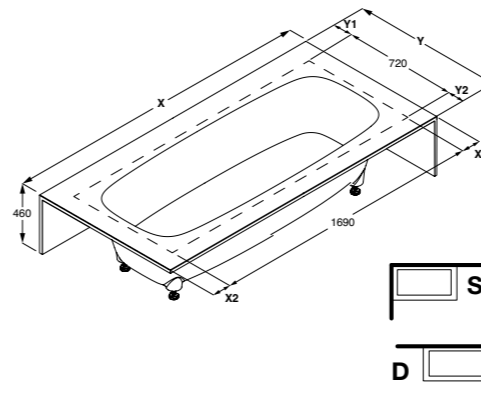
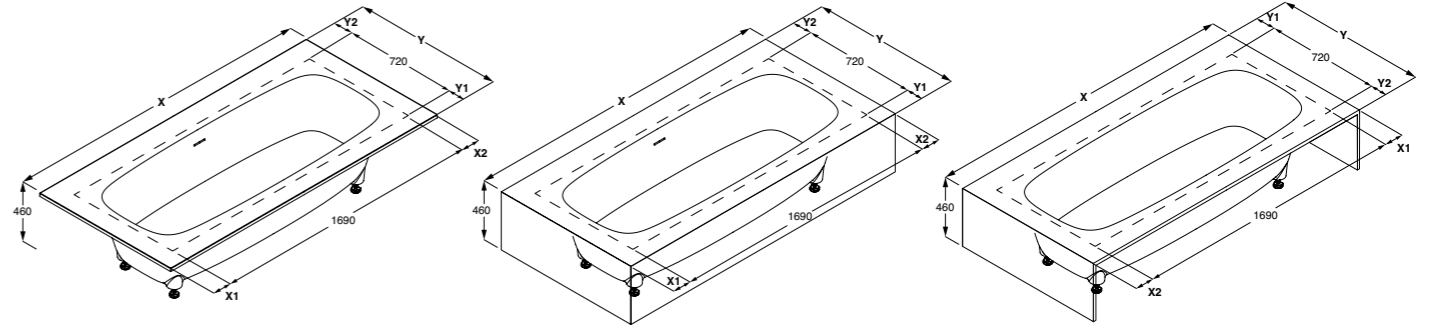

### Ark

/ Vasca da bagno a misura Cliente in Cristalplant® con doppio schienale. Dimensioni: L. 1690+1910 mm / P. 720+910 mm / H. 460 mm. Vasca da INCASSO a misura Cliente, bianco cod. QAKSSR01. Vasca PANNELLATA AD ISOLA a misura Cliente, versione tutto bianco cod. QAKISR01 - versione bianco con rivestimento esterno in vernice grigio antracite cod. QAKISS01. Vasca PANNELLATA A PENISOLA a misura Cliente, versione tutto bianco cod. QAKPER01 - versione bianco con rivestimento esterno in vernice grigio antracite cod. QAKPES01. Vasca PANNELLATA AD ANGOLO a misura Cliente, versione tutto bianco cod. QAKANR01 S-D - versione bianco con rivestimento esterno in vernice grigio antracite cod. QAKANS01 S-D. Vasca PANNELLATA IN NICCHIA a misura Cliente, versione tutto bianco cod. QAKICR01 - versione bianco con rivestimento esterno in vernice grigio antracite cod. QAKICS01.

/ Customised bathtub in Cristalplant® with double backrest slope. Dimensions: L. 1690+1910 mm / P. 720+910 mm / H. 460 mm. Customised BUILT-IN bathtub, white cod. QAKSSR01. Customised FREE-STANDING bathtub WITH PANELS, totally white cod. QAKISR01 - white + coating made of anthracite grey paint cod. QAKISS01. Customised PENINSULA bathtub WITH PANELS, totally white cod. QAKPER01 - white + coating made of anthracite grey paint cod. QAKPES01. Customised CORNER bathtub WITH PANELS, totally white cod. QAKANR01 S-D - white + coating made of anthracite grey paint cod. QAKANS01 S-D. Customised NICHE bathtub WITH PANELS, totally white cod. QAKICR01 - white + coating made of anthracite grey paint cod. QAKICS01.

/ Baignoire à mesure Client en Cristalplant® avec double appuie-dos. Dimensions: L. 1690+1910 mm / P. 720+910 mm / H. 460 mm. Baignoire A ENCASTREMENT sur mesure Client, blanc cod. QAKSSR01. Baignoire REVETUE DE PANNEAUX EN ÎLOT sur mesure Client, tout blanc cod. QAKISR01 - Blanc + revêtement externe avec peinture gris anthracite cod. QAKISS01. Baignoire REVETUE DE PANNEAUX EN PENINSULE sur mesure Client, tout blanc cod. QAKPER01 - Blanc + revêtement externe avec peinture gris anthracite cod. QAKPES01. Baignoire REVETUE DE PANNEAUX D'ANGLE sur mesure Client, tout blanc cod. QAKANR01 S-D - Blanc + revêtement externe avec peinture gris anthracite cod. QAKANS01 S-D. Baignoire REVETUE DE PANNEAUX EN NICHE sur mesure Client, tout blanc cod. QAKICR01 - Blanc + revêtement externe avec peinture gris anthracite cod. QAKICS01.

/ Badewanne nach Kundenmaß aus Cristalplant® mit zwei Innenschrägen. Abmessungen: L. 1690+1910 mm / P. 720+910 mm / H. 460 mm. EINBAU-Badewanne nach Kundenmaß, weiß Cod. QAKSSR01. INSEL-Badewanne MIT PANEELVERKLEIDUNG nach Kundenmaß, vollständig weiß Cod. QAKISR01 - Weiß + Außenlackierung anthrazitgrau Cod. QAKISS01. HALBINSEL-Badewanne MIT PANEELVERKLEIDUNG nach Kundenmaß, vollständig weiß Cod. QAKPER01 - Weiß + Außenlackierung anthrazitgrau Cod. QAKPES01. ECK-Badewanne MIT PANEELVERKLEIDUNG nach Kundenmaß, vollständig weiß Cod. QAKANR01 S-D - Weiß + Außenlackierung anthrazitgrau Cod. QAKANS01 S-D. NISCHEN-Badewanne MIT PANEELVERKLEIDUNG nach Kundenmaß, vollständig weiß Cod. QAKICR01 - Weiß + Außenlackierung anthrazitgrau Cod. QAKICS01.

/ Bañera a medida cliente en Cristalplant® con doble panel trasero. Dimensiones: L. 1690+1910 mm / P. 720+910 mm / H. 460 mm. Bañera EMPOTRABLE a medida cliente, blanco cod. QAKSSR01. Bañera CON PANELES DE ISLA a medida cliente, todo blanco cod. QAKISR01 - blanco + revestimiento exterior con pintura gris antracita cod. QAKISS01. Bañera CON PANELES DE PENINSULA a medida cliente, todo blanco cod. QAKPER01 - blanco + revestimiento exterior con pintura gris antracita cod. QAKPES01. Bañera CON PANELES DE ESQUINA a medida cliente, todo blanco cod. QAKANR01 S-D - blanco + revestimiento exterior con pintura gris antracita cod. QAKANS01 S-D. Bañera CON PANELES DE NICHOS a medida cliente, todo blanco cod. QAKICR01 - blanco + revestimiento exterior con pintura gris antracita cod. QAKICS01.

## Vasche Bathtubs

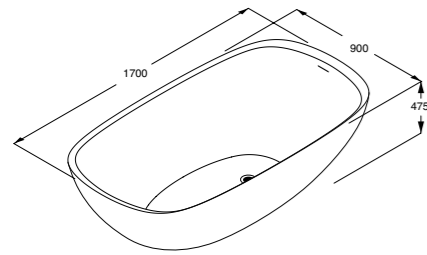

### Faroe

/ Vasca monoblocco in Cristalplant® bianco. Completa di piletta cromo, sifone e troppopieno. L. 1700 P. 900 H. 475 mm. Versione tutto bianco cod. QAEISR01. Versione bianco con rivestimento esterno in vernice grigio antracite cod. QAEISS01.

/ Monobloc bathtub in white Cristalplant®. Equipped with chromium-plated waste drain, siphon and overflow. L. 1700 P. 900 H. 475 mm. Totally white cod. QAEISR01. White + coating made of anthracite grey paint cod. QAEISS01.

/ Baignoire monobloc en Cristalplant® blanc. Munie de bonde chromée, siphon et trop-plein. L. 1700 P. 900 H. 475 mm. Tout blanc cod. QAEISR01. Blanc + revêtement externe avec peinture gris anthracite cod. QAEISS01.

/ Blockbadewanne aus Cristalplant® weiß. Mit verchromter Ablaufgarnitur, Siphon und Überlauf. L. 1700 P. 900 H. 475 mm. Vollständig weiß Cod. QAEISR01. Weiß + Außenlackierung anthrazitgrau Cod. QAEISS01.

/ Bañera monobloque en Cristalplant® blanco. Dotada de válvula cromada, sifón y rebosadero. L. 1700 P. 900 H. 475 mm. Versiones: todo blanco cod. QAEISR01; blanco + revestimiento exterior con pintura gris antracita cod. QAEISS01.

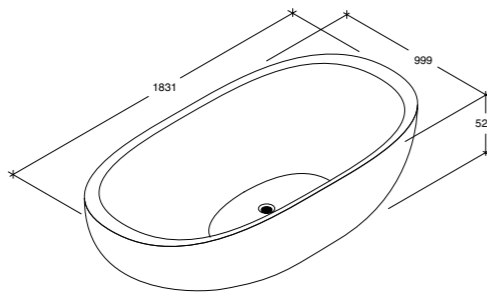

### Fisher Island Stone

/ Vasca monoblocco in massello di pietra naturale (marmo bianco Carrara/pietra Serena/marmo Emperador Dark). L. 1831 P. 999 H. 527 mm. Cod. QAFISM01.

/ Monobloc bathtub in solid natural stone (marble white Carrara/Serena stone/marble Emperador Dark). L. 1831 P. 999 H. 527 mm. Cod. QAFISM01.

/ Baignoire en un seul bloc en massif de pierre naturelle (marbre blanc Carrara/pierre Serena/marbre Emperador Dark). L. 1831 P. 999 H. 527 mm. Cod. QAFISM01.

/ Blockbadewanne aus massivem Naturstein (weiß Carrara-Marmor/Stein Serena/Marmor Emperador Dark). L. 1831 P. 999 H. 527 mm. Cod. QAFISM01.

/ Bañera monobloque en piedra natural (mármol blanco Carrara/piedra Serena/mármol Emperador Dark). L. 1831 P. 999 H. 527 mm. Cod. QAFISM01.

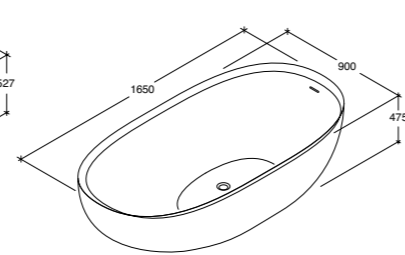

### Fisher Island

/ Vasca monoblocco in Ceramilux® bianco opaco. Completa di piletta cromo, sifone e troppopieno. L. 1650, P. 900, H. 475 mm. Versione tutto bianco cod. QAFISX02. Versione bianco con rivestimento esterno in vernice grigio antracite cod. QAFISS01.

/ Monobloc bathtub in white Ceramilux®, matt. Equipped with chromium-plated waste drain, siphon and overflow. L. 1650, P. 900, H. 475 mm. Totally white cod. QAFISX02. White + coating made of anthracite grey paint cod. QAFISS01.

/ Baignoire en un seul bloc en Ceramilux® blanc mat. Munie de bonde chromée, siphon et trop-plein. L. 1650, P. 900, H. 475 mm. Tout blanc cod. QAFISX02. Blanc + revêtement externe avec peinture gris anthracite cod. QAFISS01.

/ Blockbadewanne aus Ceramilux® mattweiß. Mit verchromtem Ablauf, Siphon und Überlauf. L. 1650, P. 900, H. 475 mm. Vollständig weiß cod. QAFISX02. Weiß + Außenlackierung anthrazitgrau cod. QAFISS01.

/ Bañera monobloque en Ceramilux® blanco mate. Dotada de válvula cromada, sifón y rebosadero. L. 1650, P. 900, H. 475 mm. Versiones: todo blanco cod. QAFISX02 / blanco + revestimiento exterior con pintura gris antracita cod. QAFISS01.

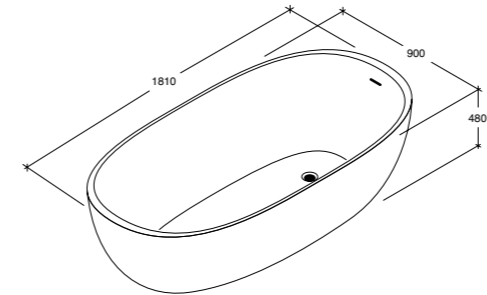

### Iceland

/ Vasca monoblocco in Cristalplant®, completa di piletta, sifone e troppopieno. L. 1810 P. 900 H. 480 mm. Versione tutto bianco QAIISR01. Versione bianco con rivestimento esterno in vernice grigio antracite QAIISS01.

/ Monobloc bathtub in Cristalplant®, with waste-drain, siphon and overflow. L. 1810 P. 900 H. 480 mm. Totally white QAIISR01. White + coating made of anthracite grey paint QAIISS01.

/ Baignoire en un seul bloc en Cristalplant®, y compris le vidange, siphon e trop-plein. L. 1810 P. 900 H. 480 mm. Tout blanc QAIISR01. Blanc + revêtement externe avec peinture gris anthracite QAIISS01.

/ Blockbadewanne aus Cristalplant®, mit Ablauf, Überlauf und Siphon. L. 1810 P. 900 H. 480 mm. Vollständig weiß QAIISR01. Weiß + Außenlackierung anthrazitgrau QAIISS01.

/ Bañera monobloque en Cristalplant®, dotada de válvula acabado inox, sifón y rebosadero. L. 1810 P. 900 H. 480 mm. Versiones: todo blanco QAIISR01 / blanco + revestimiento exterior con pintura gris antracita QAIISS01.

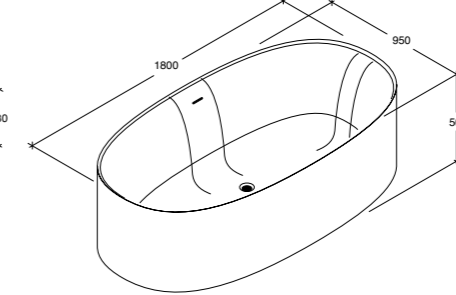

### Sabbia

/ Vasca monoblocco in Cristalplant®, completa di piletta, sifone e troppopieno. L. 1800 P. 950 H. 500 mm. QAYISR01.

/ Monobloc bathtub in white Cristalplant® with waste-drain, siphon and overflow. L. 1800 P. 950 H. 500 mm. QAYISR01.

/ Baignoire en un seul bloc en Cristalplant®, y compris le vidange, siphon e trop-plein. L. 1800 P. 950 H. 500 mm. QAYISR01.

/ Blockbadewanne aus Cristalplant®, mit Ablauf, Überlauf und Siphon. L. 1800 P. 950 H. 500 mm. QAYISR01.

/ Bañera monobloque en Cristalplant®, dotada de válvula, sifón y rebosadero. L. 1800 P. 950 H. 500 mm. QAYISR01.

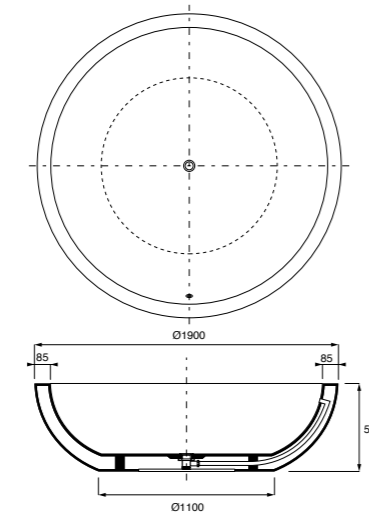
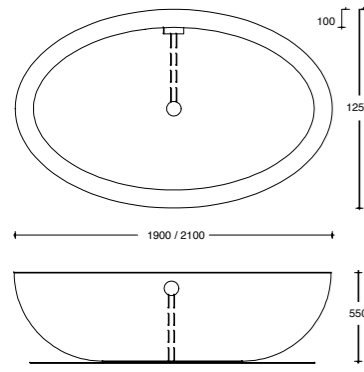

### I Fiumi: Po

/ Vasca realizzata in massello di pietra naturale o Corian® termoformato, completa di tappo, sifone e troppopieno. L. 1900 P. 1250 H. 550 mm in pietra Serena cod. QAPISM04. L. 2100 P. 1250 H. 550 mm in pietra Serena cod. QAPISM05. L. 1910 P. 1260 H. 550 mm in Corian®, cod. QAPISP03.

/ Bathtub in solid natural stone or thermoformed Corian®, with plug, waste-drain and overflow. L. 1900 P. 1250 H. 550 mm in Serena stone cod. QAPISM04. L. 2100 P. 1250 H. 550 mm in Serena stone cod. QAPISM05. L. 1910 P. 1260 H. 550 mm in Corian®, cod. QAPISP03.

/ Baignoire en pierre naturelle ou Corian® thermoformé muni de bouchon, bonde et trop-plein. L. 1900 P. 1250 H. 550 mm pierre Serena cod. QAPISM04. L. 2100 P. 1250 H. 550 mm pierre Serena cod. QAPISM05. L. 1910 P. 1260 H. 550 mm in Corian®, cod. QAPISP03.

/ Badewanne aus massivem Natur-Stein oder Corian® thermoformiert, mit Stopfen, Ablaufgarnitur und Überlauf. L. 1900 P. 1250 H. 550 mm Serena Stein cod. QAPISM04. L. 2100 P. 1250 H. 550 mm Serena Stein cod. QAPISM05. L. 1910 P. 1260 H. 550 mm aus Corian®, cod. QAPISP03.

/ Bañera monobloque de piedra natural o en Corian® termoformato. Dotada de válvula acabado inox, sifón y rebosadero. L. 1900 P. 1250 H. 550 mm en piedra Serena cod. QAPISM04. L. 2100 P. 1250 H. 550 mm en piedra Serena cod. QAPISM05. L. 1910 P. 1260 H. 550 mm en Corian®, cod. QAPISP03.

### I Fiumi: Tevere

/ Vasca realizzata in Corian® bianco termoformato, sezione rotonda, completa di piletta, troppopieno e sifone. L. 1900 P. 1900 H. 550 mm QAVISPO1.

/ Bathtub in white thermoformed Corian®, round version, provided with waste-drain, overflow and siphon. L. 1900 P. 1900 H. 550 mm QAVISPO1.

/ Baignoire en Corian® blanc thermoformé, en section circulaire, avec bonde, trop-plein et siphon. L. 1900 P. 1900 H. 550 mm QAVISPO1.

/ Badewanne aus weißem Corian® thermoformiert, runde Version, mit Ablauf, Siphon und Überlauf. L. 1900 P. 1900 H. 550 mm QAVISPO1.

/ Bañera monobloque en Corian® blanco termoformato. Dotada de válvula acabado inox, sifón y rebosadero. L. 1900 P. 1900 H. 550 mm QAVISPO1.

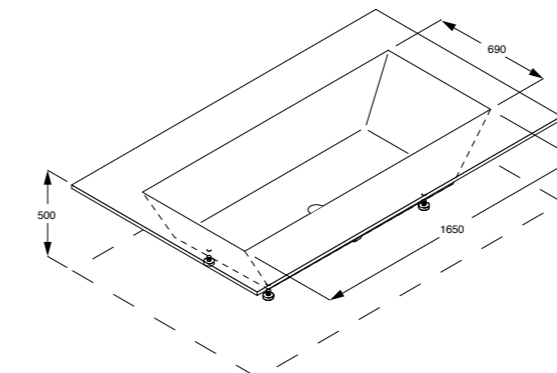

### Swim C

/ Vasca da bagno con doppio schienale interamente realizzata in Cristalplant® bianco, disponibile nelle seguenti versioni: da incasso, pannellata ad isola, pannellata a penisola, pannellata ad angolo, pannellata per nicchia e con vani a giorno. / Bathtubs in white Cristalplant® with double backrest slope, available in following versions: built-in - freestanding with panels - peninsula with panels - corner with panels - niche with panels - with open-faced compartments. / Baignoire en Cristalplant® avec double appuie-dos, disponible dans les versions suivantes: encastrément - revetue de panneaux en îlot - revetue de panneaux en péninsule - revetue de panneaux d'angle - revetue pour niche - avec compartiments ouverts. / Badewannen, mit zwei Innenschrägen, aus Cristalplant® weiß, verfügbar in folgenden Varianten: Einbau - Inselbadewanne mit Verkleidungspaneele - Eckbadewanne mit Verkleidungspaneele - Nischenbadewanne mit Verkleidungspaneele - mit offenen Fächern. / Bañera en Cristalplant® con doble respaldo. Versiones: empotrada - con paneles de isla - con paneles de peninsula - con paneles de esquina - con paneles para nicho - con compartimentos abiertos.

/ Built-in and under-mounted bathtub in white Cristalplant®, wall fixing and covering panels are charged to the customer. They are provided with adjustable feet, chromium-plated waste-drain and siphon. Measures: 1850x790 mm, cod. QAWSSR01. 1950x880 mm, cod. QAWSSR02. 2050x980 mm, cod. QAWSSR03. 2050x1250 mm, cod. QAWSSR04. A misura cliente (misura min. e max. stabilite), cod. QAWSSR05.

/ Bañera empotrable en Cristalplant®, con pies ajustables, válvula cromada y sifón. Para instalación arriba/bajo encimera, con obras de albañilería y revestimiento a cargo del cliente. Medidas: 1850x790 mm, cod. QAWSSR01. 1950x880 mm, cod. QAWSSR02. 2050x980 mm, cod. QAWSSR03. 2050x1250 mm, cod. QAWSSR04. Nach Kundenmaß (min. und max. Dimensionen sind fest), cod. QAWSSR05.

/ Bañera empotrable en Cristalplant®, con pies ajustables, válvula cromada y sifón. Para instalación arriba/bajo encimera, con obras de albañilería y revestimiento a cargo del cliente. Medidas: 1850x790 mm, cod. QAWSSR01. 1950x880 mm, cod. QAWSSR02. 2050x980 mm, cod. QAWSSR03. 2050x1250 mm, cod. QAWSSR04. A medida cliente (con las medidas mínimas y máximas permitidas), cod. QAWSSR05.

/ Bañera empotrable en Cristalplant®, con pies ajustables, válvula cromada y sifón. Para instalación arriba/bajo encimera, con obras de albañilería y revestimiento a cargo del cliente. Medidas: 1850x790 mm, cod. QAWSSR01. 1950x880 mm, cod. QAWSSR02. 2050x980 mm, cod. QAWSSR03. 2050x1250 mm, cod. QAWSSR04. Sur mesure client (min. et max. mesures fixes), cod. QAWSSR05.

## Vasche Bathtubs

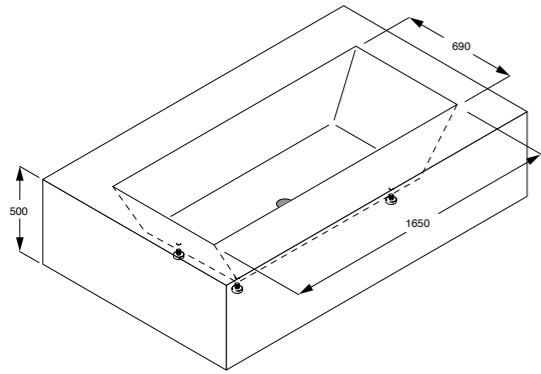

### Swim C

/ Vasca pannellata a isola in Cristalplant® bianco. - Pannelli di rivestimento sui 4 lati - completa di piedini regolabili, piletta cromata e sifone. Misure: 1850 x 830 mm, cod. QAWISR01. 1950 x 880 mm, cod. QAWISR02. 2050 x 980 mm, cod. QAWISR03. 2050 x 1250 mm, cod. QAWISR04. A misura cliente (misure min. e max. stabilite), cod. QAWISR05. / Freestanding bathtub with panels in white Cristalplant® - Covering panels on 4 sides - They are provided with adjustable feet, chromium-plated waste-drain and siphon. Measures: 1850x830 mm, cod. QAWISR01. 1950x880 mm, cod. QAWISR02. 2050x980 mm, cod. QAWISR03. 2050x1250 mm, cod. QAWISR04. Customised (fixed min. and max. sizes), cod. QAWISR05. / Baignoire revêtue de panneaux en îlot en Cristalplant® blanc - Panneaux de revêtement sur les 4 côtés - Dotée de pieds réglables, bonde chromé et siphon. Mesures: 1850x830 mm, cod. QAWISR01. 1950x880 mm, cod. QAWISR02. 2050x980 mm, cod. QAWISR03. 2050x1250 mm, cod. QAWISR04. Sur mesure client (min. et max. mesures fixes), cod. QAWISR05.

/ Insel-Badewanne aus Cristalplant® weiß mit Verkleidungspaneelen - Verkleidungspaneelen auf 4 Seiten - Sie ist ausgestattet mit verstellbaren Füßen, Siphon und Ablaufgarnitur verchromt. Dimensionen: 1850x830 mm, cod. QAWISR01. 1950x880 mm, cod. QAWISR02. 2050x980 mm, cod. QAWISR03. 2050x1250 mm, cod. QAWISR04. Nach Kundenmaß (min. und max. Dimensionen sind fest), cod. QAWISR05. / Bañera con paneles de isla en Cristalplant®, con pies ajustables, válvula cromada y sifón. Paneles de revestimiento en los 4 lados. Medidas: 1850x830 mm, cod. QAWISR01. 1950x880 mm, cod. QAWISR02. 2050x980 mm, cod. QAWISR03. 2050x1250 mm, cod. QAWISR04. A medida cliente (con las medidas mínimas y máximas permitidas), cod. QAWISR05.

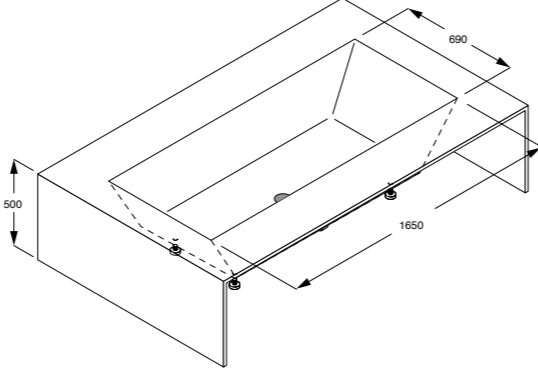

### Swim C

/ Vascapannellata a penisola in Cristalplant® bianco - Pannelli di rivestimento su 3 lati - Completa di piedini regolabili, piletta cromata e sifone. Misure: 1850x790 mm, cod. QAWPER01. 1950x880 mm, cod. QAWPER02. 2050x980 mm, cod. QAWPER03. 2050x1250 mm, cod. QAWPER04. A misura cliente (misure min. e max. stabilite), cod. QAWPER05. / Peninsula bathtub with panels in white Cristalplant® - Covering panels on 3 sides - They are provided with adjustable feet, chromium-plated waste-drain and siphon. Measures: 1850x790 mm, cod. QAWPER01. 1950x880 mm, cod. QAWPER02. 2050x980 mm, cod. QAWPER03. 2050x1250 mm, cod. QAWPER04. Customised (fixed min. and max. sizes), cod. QAWPER05.

/ Baignoire revêtue de panneaux avec péninsule en Cristalplant® blanc - Panneaux de revêtement sur 3 côtés - Dotée de pieds réglables, bonde chromé et siphon. Mesures: 1850x790 mm, cod. QAWPER01. 1950x880 mm, cod. QAWPER02. 2050x980 mm, cod. QAWPER03. 2050x1250 mm, cod. QAWPER04. Sur mesure client (min. et max. mesures fixes), cod. QAWPER05. / Halbinsel-Badewanne aus Cristalplant® weiß mit Verkleidungspaneelen - Verkleidungspaneelen auf 3 Seiten. Sie ist ausgestattet mit verstellbaren Füßen, Siphon und Ablaufgarnitur verchromt. Dimensionen: 1850x790 mm, cod. QAWPER01. 1950x880 mm, cod. QAWPER02. 2050x980 mm, cod. QAWPER03. 2050x1250 mm, cod. QAWPER04. Nach Kundenmaß (min. und max. Dimensionen sind fest), cod. QAWPER05.

/ Bañera con paneles de península, en Cristalplant®, con pies ajustables, válvula cromada y sifón. Paneles de revestimiento en los 3 lados. Medidas: 1850x790 mm, cod. QAWPER01. 1950x880 mm, cod. QAWPER02. 2050x980 mm, cod. QAWPER03. 2050x1250 mm, cod. QAWPER04. A medida cliente (con las medidas mínimas y máximas permitidas), cod. QAWPER05.

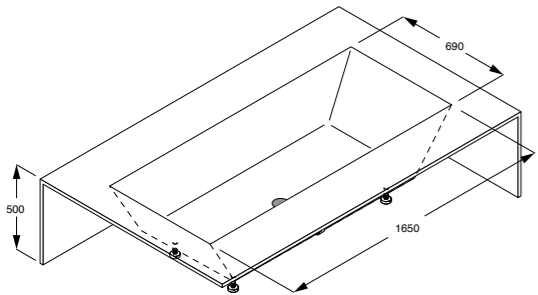

### Swim C

/ Vasca pannellata ad angolo in Cristalplant® bianco - Pannelli di rivestimento su 2 lati - Completa di piedini regolabili, piletta cromata e sifone. Misure: 1850x790 mm, cod. QAWANR01S-D. 1950x880 mm, cod. QAWANR02 S-D. 2050x980 mm, cod. QAWANR03 S-D. 2050x1250 mm, cod. QAWANR04 S-D. A misura cliente (misure min. e max. stabilite), cod. QAWANR05 S-D. / Corner bathtub with panels in white Cristalplant® - Covering panels on 2 sides - They are provided with adjustable feet, chromium-plated waste-drain and siphon. Measures: 1850x790 mm, cod. QAWANR01 S-D. 1950x880 mm, cod. QAWANR02 S-D. 2050x980 mm, cod. QAWANR03 S-D. 2050x1250 mm, cod. QAWANR04 S-D. Customised (fixed min. and max. sizes), cod. QAWANR05 S-D. / Baignoire revêtue de panneaux d'angle en Cristalplant® blanc - Panneaux de revêtement sur 2 côtés - Dotée de pieds réglables, bonde chromé et siphon. Mesures: 1850x790 mm, cod. QAWANR01 S-D. 1950x880 mm, cod. QAWANR02 S-D. 2050x980 mm, cod. QAWANR03 S-D. 2050x1250 mm, cod. QAWANR04 S-D. Sur mesure client (min. et max. mesures fixes), cod. QAWANR05 S-D.

/ Eck-Badewanne aus Cristalplant® weiß mit Verkleidungspaneelen - Verkleidungspaneelen auf 2 Seiten. Sie ist ausgestattet mit verstellbaren Füßen, Siphon und Ablaufgarnitur verchromt. Dimensionen: 1850x790 mm, cod. QAWANR01 S-D. 1950x880 mm, cod. QAWANR02 S-D. 2050x980 mm, cod. QAWANR03 S-D. 2050x1250 mm, cod. QAWANR04 S-D. Nach Kundenmaß (min. und max. Dimensionen sind fest), cod. QAWANR05 S-D.

/ Bañera con paneles de esquina en Cristalplant®, con pies ajustables, válvula cromada y sifón. Paneles de revestimiento en los 2 lados. Medidas: 1850x790 mm, cod. QAWANR01 S-D. 1950x880 mm, cod. QAWANR02 S-D. 2050x980 mm, cod. QAWANR03 S-D. 2050x1250 mm, cod. QAWANR04 S-D. A medida cliente (con las medidas mínimas y máximas permitidas), cod. QAWANR05 S-D.

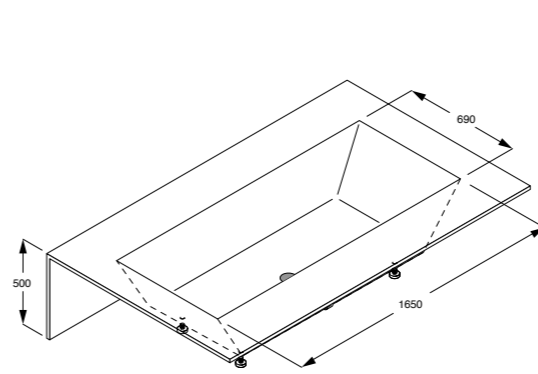

### Swim C

/ Vasca pannellata in nicchia in Cristalplant® bianco - Pannelli di rivestimento su 1 lato - Completa di piedini regolabili, piletta cromata e sifone. Misure: 1850x790 mm, cod. QAWICR01. 1950x880 mm, cod. QAWICR02. 2050x980 mm, cod. QAWICR03. 2050x1250 mm, cod. QAWICR04. A misura cliente (misure min. e max. stabilite), cod. QAWICR05. / Niche bathtub with panels, in white Cristalplant® - Covering panels on 1 side - They are provided with adjustable feet, chromium-plated waste-drain and siphon. Measures: 1850x790 mm, cod. QAWICR01. 1950x880 mm, cod. QAWICR02. 2050x980 mm, cod. QAWICR03. 2050x1250 mm, cod. QAWICR04. Customised (fixed min. and max. sizes), cod. QAWICR05. / Baignoire revêtue de panneaux en niche en Cristalplant® blanc - Panneaux de revêtement sur 1 côté - Dotée de pieds réglables, bonde chromé et siphon. Mesures: 1850x790 mm, cod. QAWICR01. 1950x880 mm, cod. QAWICR02. 2050x980 mm, cod. QAWICR03. 2050x1250 mm, cod. QAWICR04. Sur mesure client (min. et max. mesures fixes), cod. QAWICR05.

/ Nischen-Badewanne aus Cristalplant® weiß mit Verkleidungspaneelen - Verkleidungspaneelen auf 1 Seite. Sie ist ausgestattet mit verstellbaren Füßen, Siphon und Ablaufgarnitur verchromt. Dimensionen: 1850x790 mm, cod. QAWICR01. 1950x880 mm, cod. QAWICR02. 2050x980 mm, cod. QAWICR03. 2050x1250 mm, cod. QAWICR04. Nach Kundenmaß (min. und max. Dimensionen sind fest), cod. QAWICR05. / Bañera con paneles de nicho en Cristalplant®, con pies ajustables, válvula cromada y sifón. Paneles de revestimiento en 1 lado. Medidas: 1850x790 mm, cod. QAWICR01. 1950x880 mm, cod. QAWICR02. 2050x980 mm, cod. QAWICR03. 2050x1250 mm, cod. QAWICR04. A medida cliente (con las medidas mínimas y máximas permitidas), cod. QAWICR05.

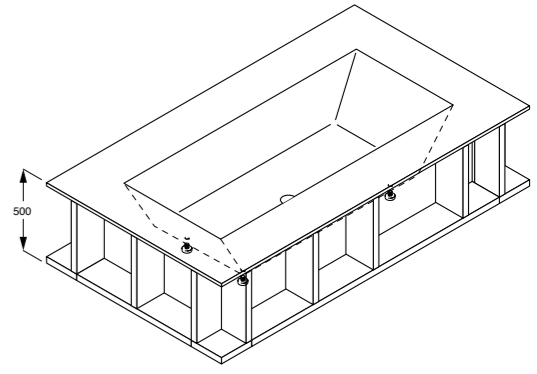

### Swim C

/ Vasca in Cristalplant® bianco con vani a giorno in finitura - Completa di piedini regolabili, piletta cromata e sifone. Vasca per installazione in nicchia/isola, 1 vano a giorno + 3 pannelli fissi, 1800x1050 mm, QAWGNF01 S-D. Vasca per installazione ad angolo/isola sinistra, 2 vani a giorno + 2 pannelli fissi, 2000x1050 mm, QAWGAF01 S-D. Vasca per installazione ad angolo/isola destra, 2 vani a giorno + 2 pannelli fissi, 2000x1050 mm, QAWGAF02 S-D. Vasca per installazione a penisola / isola, 3 vani a giorno + 1 pannello fisso, 2200x1050 mm, QAWGPF01 S-D. Vasca per installazione a isola, 4 vani a giorno, 2200x1250 mm, QAWGIF01. / Bathtub in white Cristalplant® with finished open-faced compartments. They are provided with adjustable feet, chromium-plated waste-drain and siphon. Niche/freestanding bathtub with 1 open-faced compartment + 3 fixed panels, 1800x1050 mm. QAWGNF01 S-D. Left corner/freestanding bathtub with 2 open-faced compartments + 2 fixed panels, 2000x1050 mm. QAWGAF01 S-D. Right corner/freestanding bathtub with 2 open-faced compartments + 2 fixed panels, 2000x1050 mm. QAWGAF02 S-D. Peninsula/freestanding bathtub with 3 open-faced compartments + 1 fixed panel, 2200x1050 mm. QAWGPF01 S-D. Freestanding bathtub with 4 open-faced compartments, 2200x1250 mm. QAWGIF01.

/ Baignoire en Cristalplant® blanc avec compartiments ouverts en finition - Dotée de pieds réglables, bonde chromé et siphon. Baignoire pour installation en niche/îlot, 1 compartiment ouvert + 3 panneaux fixes, 1800x1050 mm. QAWGN01 S-D. Baignoire pour installation d'angle/îlot gauche, 2 compartiments ouverts + 2 panneaux fixes 2000x1050 mm. QAWGAF01 S-D. Baignoire pour installation d'angle/îlot droite, 2 compartiments ouverts + 2 panneaux fixes, 2000x1050 mm. QAWGAF02 S-D. Baignoire pour installation avec péninsule/îlot, 3 compartiments ouverts + 1 panneau fixe, 2200x1050 mm. QAWGPF01 S-D. Baignoire pour installation en îlot, 4 compartiments ouverts, 2200x1250 mm. QAWGIF01.

/ Badewanne aus Cristalplant® weiß mit offenen Fächern in Ausführung. Sie ist ausgestattet mit verstellbaren Füßen, Siphon und Ablaufgarnitur verchromt. Nischen/Insel-Badewanne mit 1 offenem Fach + 3 festen Verkleidungspaneelen, 1800x1050 mm, QAWGNF01 S-D. Eck/Insel-Badewanne links mit 2 offenen Fächern + 2 festen Verkleidungspaneelen 2000x1050 mm, QAWGAF01 S-D. Eck/Insel-Badewanne rechts mit 2 offenen Fächern + 2 festen Verkleidungspaneelen, 2000x1050 mm, QAWGAF02 S-D. Halbinsel/Insel-Badewanne mit 3 offenen Fächern + 1 festem Verkleidungspaneel, 2200x1050 mm, QAWGPF01 S-D. Insel-Badewanne mit 4 offenen Fächern, 2200 x 1250 mm, QAWGIF01.

/ Bañera en Cristalplant® con compartimentos abiertos, con pies ajustables, válvula cromada y sifón. En nicho/isla, 1 compartimento abierto + 3 paneles fijos, 1800x 1050 mm, QAWGNF01 S-D. De esquina/isla izquierda, 2 compartimentos abiertos + 2 paneles fijos, 2000x1050 mm, QAWGAF01 S-D. De esquina/isla derecha, 2 compartimentos abiertos + 2 paneles fijos, 2000 x 1050 mm, QAWGAF02 S-D. DE península/isla, 3 compartimentos abiertos + 1 panel fijo, 2200 x1050 mm, QAWGPF01 S-D. De isla, 4 compartimentos abiertos, 2200x1250 mm, QAWGIF01.

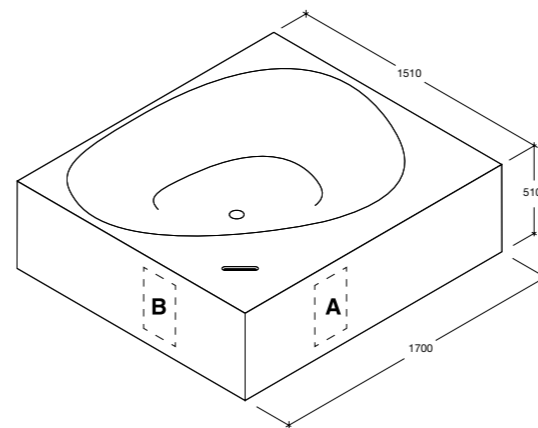

### Terra

/ Vasca monoblocco in Cristalplant®, completa di piletta, sifone e troppopieno, erogazione dal bordo vasca, rubinetteria posizionata a lato. Misure: 1700x1510 x H. 500 mm. Senza predisposizione rubinetteria, QARISR01. Con sportello laterale contenente gruppo vasca, formato da miscelatore, doccia a mano comandato da miscelatore. Posizionamento sportello "A" QARISR04. Posizionamento sportello "B" QARISR05. / Monobloc bathtub in Cristalplant®, Equipped with chromium-plated waste drain, siphon and overflow. Water supply from bathtub edge. Measures: 1700x1510 x H. 500 mm. Without tap arrangement, QARISR01. Bathtub tap on side, composed with: mixer, hand shower controlled by the mixer. With tap arrangement on side A, QARISR04. With tap arrangement on side B, QARISR05.

/ Baignoire monobloc en Cristalplant®, avec bonde, siphon et trop plein, débit du plan baignoire, positionnement batterie robinet à côté. Dimensions: 1700x1510 x H. 500 mm. Sans prédisposition batterie robinet pour baignoire, QARISR01. Petite porte laterale contenant batterie baignoire, composée de: mitigeur, petite douchette à main, commande de mitigeur. Position petite porte "A" QARISR04. Position petite porte "B" QARISR05.

/ Blockbadewanne aus Cristalplant®, mit verchromtem Ablauf, Siphon und Überlauf. Wasserzulauf an Wannenrand. Maße: 1700x1510 x H. 500 mm. Ohne Ausschnitt für Armatur, QARISR01. Hinter seitlicher Klappe Wannenarmatur mit Mischer, Brause mit entsprechendem Mischer. Mit seitlicher Klappe und Armaturen, Position A, QARISR04. Mit seitlicher Klappe und Armaturen, Position B, QARISR05. / Bañera monobloque en Cristalplant® blanco. Dotada de válvula cromada, sifón y rebosadero. Erogación desde borde bañera. Medidas: 1700 x 1510 x H. 500 mm. Versiones: no preparada para grifería / con tapa y grifería inox (incluye mezclador, ducha teléfono con mezclador específico). No preparada para grifería QARISR01. Con tapa lateral y grifería, posición A, QARISR04. Con tapa lateral y grifería, posición B, QARISR05.

## Sanitari Sanitary Fixtures

### Galassia

/ Sanitari Galassia, serie SAO2 in ceramica bianca lucida. / Sanitary fixtures GALASSIA – Model SAO2 – in white polished ceramic. / Sanitaires GALASSIA – Série SAO2 – Céramique blanche polie. / Sanitäranlagen GALASSIA – SAO2 – aus Keramik weiß glänzend. / Sanitarios Galassia SAO2 en cerámica blanco brillante.

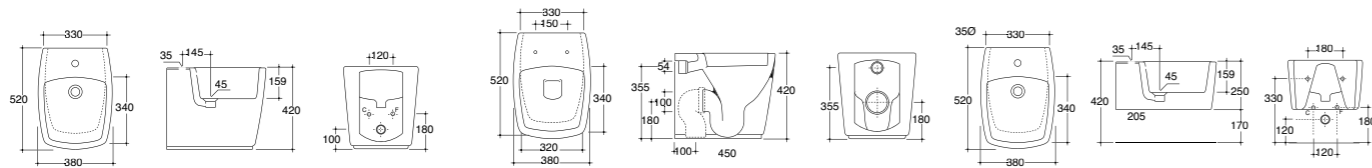

/ Bidet a terra monoforo (peso 27,5 kg). L. 380 P. 520 H. 420 mm. QSSBTC01.  
/ Floor-mounted bidet, with 1 tap hole (weight 27,5 kg). L. 380 P. 520 H. 420 mm. QSSBTC01.  
/ Bidet de sol monotrou (poids 27,5 kg). L. 380 P. 520 H. 420 mm. QSSBTC01.  
/ Stand-Blockbidet, Einloch-Ausschnitt (Gewicht 27,5 kg). L. 380 P. 520 H. 420 mm. QSSBTC01.  
/ Bidé a suelo un agujero (peso 27,5 kg). L. 380 P. 520 H. 420 mm. QSSBTC01.

/ Vaso universale a terra, scarico terra/parete (peso 27,1 kg). L. 380 P. 520 H. 420 mm. QSSVTC01.  
/ Floor-mounted toilet bowl, floor or wall drainage (weight 27,1 kg) L. 380 P. 520 H. 420 mm. QSSVTC01.  
/ WC de sol, évacuation au sol ou murale (poids 27,1 kg) L. 380 P. 520 H. 420 mm. QSSVTC01.  
/ Stand-WC, Boden-/Wand-Abfluss (Gewicht 27,1 kg) L. 380 P. 520 H. 420 mm. QSSVTC01.  
/ Inodoro a suelo, descarga a suelo/pared (peso 27,1 kg). L. 380 P. 520 H. 420 mm. QSSVTC01.

/ Bidet sospeso monoforo (peso 18 kg). L. 380 P. 520 H. 250 mm. QSSBSC01.  
/ Suspended bidet, 1 tap hole (weight 18 kg). L. 380 P. 520 H. 250 mm. QSSBSC01.  
/ Bidet suspendu monotrou (poids 18 kg). L. 380 P. 520 H. 250 mm. QSSBSC01.  
/ Wand-Bidet, Einloch-Ausschnitt (Gewicht 18 kg). L. 380 P. 520 H. 250 mm. QSSBSC01.  
/ Bidé suspendido un agujero (peso 18 kg). L. 380 P. 520 H. 250 mm. QSSBSC01.

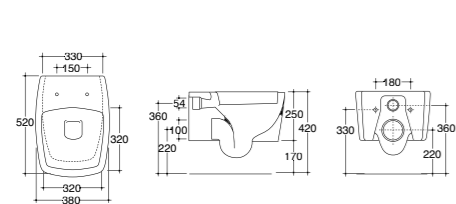

/ Vaso sospeso (peso 22,7 kg). L. 380 P. 520 H. 250 mm. QSSVSC01.  
/ Suspended toilet bowl (weight 22,7 kg). L. 380 P. 520 H. 250 mm. QSSVSC01.  
/ WC suspendu (poids 22,7 kg). L. 380 P. 520 H. 250 mm. QSSVSC01.  
/ Wand-WC (Gewicht 22,7 kg). L. 380 P. 520 H. 250 mm. QSSVSC01.  
/ Inodoro suspendido (peso 22,7 kg). L. 380 P. 520 H. 250 mm. QSSVSC01.

/ Vaso monoblocco universale, scarico terra/parete (peso 34 kg). L. 380 P. 640 H. 420 mm. QSSVTC02. Cassetta in ceramica completa di batteria di scarico a doppio flusso. AVHB001. Copriwater in resina termoindurente, cerniera con dispositivo di caduta rallentata. AVHA001. Staffe per fissaggio per bidet o vaso sospesi. AVBF003.  
/ Monobloc toilet bowl, floor/wall drainage (weight 34 kg). L. 380 P. 640 H. 420 mm. QSSVTC02. Ceramic cistern equipped with double-flow drainage mechanism. AVHB001. Tapa para inodoro en resina termoindurecida, bisagra con dispositivo de caída amortiguada. AVHA001. Estribos de fijación para bidé o inodoro suspendidos. AVBF003.  
/ WC monobloc universel, évacuation au sol ou murale (poids 34 kg). L. 380 P. 640 H. 420 mm. QSSVTC02. Cassette en céramique avec batterie d'évacuation à double flux AVHB001. Couvercle en matériau thermoudrécissable, charnière avec mécanisme de retombée ralentie AVHA001. Etriers pour fixation bidet ou WC suspendu. AVBF003.

/ Block-WC, mit Wand- oder Bodenabfluss (Gewicht 34 kg) L. 380 P. 640 H. 420 mm. QSSVTC02. Spülkasten aus Keramik, mit 2-Mengen-Spültechnik. AVHB001. WC-Sitz aus Duroplast, Scharnier mit Absenkautomatik. AVHA001. Halterungsbügel für Wand-Bidet oder Wand-WC. AVBF003.  
/ Inodoro monobloque. Descarga a suelo/pared. (peso 34 kg). L. 380 P. 640 H. 420 mm. QSSVTC02. Cisterna dotada de mecanismo de descarga de doble flujo. AVHB001. Tapa para inodoro en resina termoindurecida, bisagra con dispositivo de caída amortiguada. AVHA001. Estribos de fijación para bidé o inodoro suspendidos. AVBF003.

### Galassia

/ Sanitari Galassia, serie XES in ceramica bianca lucida. / Sanitary fixtures GALASSIA – Model XES – in white polished ceramic. / Sanitaires GALASSIA – Série XES – Céramique blanche polie. / Sanitäranlagen GALASSIA – XES – aus Keramik weiß glänzend. / Sanitarios Galassia XES en cerámica blanco brillante.

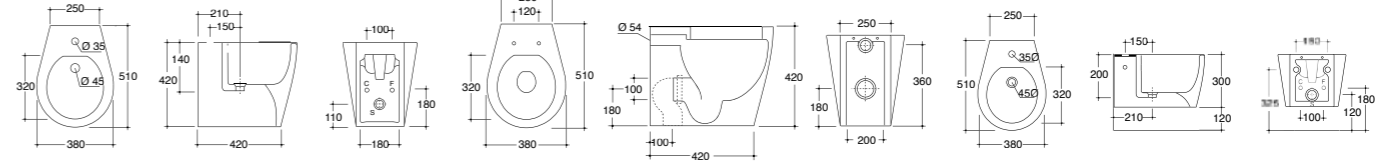

/ Bidet a terra monoforo (peso 23 kg). L. 380 P. 510 H. 420 mm. QSSBTC01.  
/ Floor-mounted bidet, with 1 tap hole (weight 23 kg). L. 380 P. 510 H. 420 mm. QSSBTC01.  
/ Bidet de sol monotrou (poids 23 kg). L. 380 P. 510 H. 420 mm. QSSBTC01.  
/ Stand-Blockbidet, Einloch-Ausschnitt (Gewicht 23 kg). L. 380 P. 510 H. 420 mm. QSSBTC01.  
/ Bidé a suelo un agujero (peso 23 kg). L. 380 P. 510 H. 420 mm. QSSBTC01.

/ Vaso universale a terra, scarico terra/parete (peso 26 kg). L. 380 P. 510 H. 420 mm. QSSVTC01.  
/ Floor-mounted toilet bowl, floor or wall drainage (weight 26 kg) L. 380 P. 510 H. 420 mm. QSSVTC01.  
/ WC de sol, évacuation au sol ou murale (poids 26 kg) L. 380 P. 510 H. 420 mm. QSSVTC01.  
/ Stand-WC, Boden/Wand-Abfluss (Gewicht 26 kg) L. 380 P. 510 H. 420 mm. QSSVTC01.  
/ Inodoro a suelo, descarga a suelo/pared (peso 26 kg). L. 380 P. 510 H. 420 mm. QSSVTC01.

/ Bidet sospeso monoforo (peso 17 kg). L. 380 P. 510 H. 300 mm. QSSBSC01.  
/ Suspended bidet, 1 tap hole (weight 17 kg). L. 380 P. 510 H. 300 mm. QSSBSC01.  
/ Bidet suspendu monotrou (poids 17 kg). L. 380 P. 510 H. 300 mm. QSSBSC01.  
/ Wand-Bidet, Einloch-Ausschnitt (Gewicht 17 kg). L. 380 P. 510 H. 300 mm. QSSBSC01.  
/ Bidé suspendido un agujero (peso 17 kg). L. 380 P. 510 H. 300 mm. QSSBSC01.

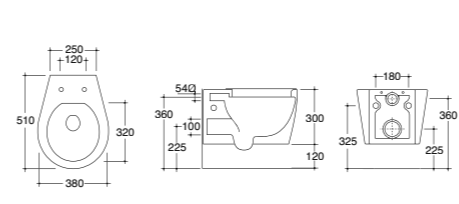

/ Vaso sospeso (peso 22 kg). L. 380 P. 510 H. 300 mm. QSSVSC01.  
/ Suspended toilet bowl (weight 22 kg). L. 380 P. 510 H. 300 mm. QSSVSC01.  
/ WC suspendu (poids 22 kg). L. 380 P. 510 H. 300 mm. QSSVSC01.  
/ Wand-WC (Gewicht 22 kg). L. 380 P. 510 H. 300 mm. QSSVSC01.  
/ Inodoro suspendido (peso 22 kg). L. 380 P. 510 H. 300 mm. QSSVSC01.

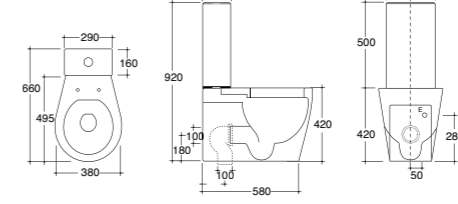

/ Vaso monoblocco universale, scarico terra / parete. L. 380 P. 660 H. 420 mm. QSSVTC02. Cassetta in ceramica completa di batteria di scarico a doppio flusso. AVHB003. Copriwater in resina termoindurente, cerniera con dispositivo di caduta rallentata. AVHA002. Staffe per fissaggio per bidet o vaso sospesi. AVBF003.  
/ Monobloc toilet bowl, floor/wall drainage. L. 380 P. 660 H. 420 mm. QSSVTC02. Ceramic cistern equipped with double-flow drainage mechanism. AVHB003. Toilet seal in thermosetting resin, hinge with soft-closing mechanism AVHA002. Fixing brackets for suspended bidet or toilet bowl. AVBF003. WC monobloc universel, évacuation au sol ou murale. L. 380 P. 660 H. 420 mm. QSSVTC02.  
/ Cassette en céramique avec batterie d'évacuation à double flux. AVHB003. Couvercle en matériau thermoudrécissable, charnière avec mécanisme de retombée ralentie AVHA002. Etriers pour fixation bidet ou WC suspendu. AVBF003.

/ Block-WC, mit Wand- oder Bodenabfluss. L. 380 P. 640 H. 420 mm. QSSVTC02. Spülkasten aus Keramik, mit 2-Mengen-Spültechnik. AVHB003. WC-Sitz aus Duroplast, Scharnier mit Absenkautomatik. AVHA002. Halterungsbügel für Wand-Bidet oder Wand-WC. AVBF003.  
/ Inodoro monobloque. Descarga a suelo/pared. L. 380 P. 640 H. 420 mm. QSSVTC02. Cisterna dotada de mecanismo de descarga de doble flujo. AVHB003. Tapa para inodoro en resina termoindurecida, bisagra con dispositivo de caída amortiguada. AVHA002. Estribos de fijación para bidé o inodoro suspendidos. AVBF003.

### XY

/ Sanitari XY in ceramica bianca lucida o opaca. / Sanitary fixtures XY in white polished or matt ceramic. / Sanitaires XY céramique blanc brillant ou mat. / Sanitäranlagen XY aus Keramik weiß glänzend oder matt. / Sanitarios XY en cerámica blanco brillante o mate

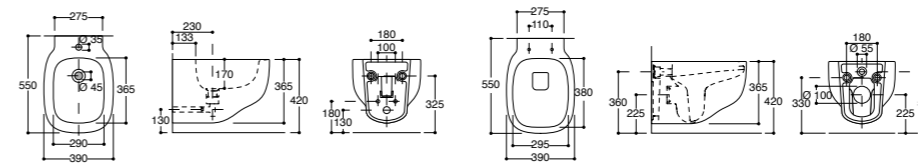

/ Bidet sospeso monoforo (peso 23 kg). L. 390 P. 550 H. 365 mm. Bianco lucido QSYBSC01; bianco opaco QSYBSB01.  
/ Suspended bidet, 1 tap hole (weight 23 kg). L. 390 P. 550 H. 365 mm. Polished white QSYBSC01; matt white QSYBSB01.  
/ Bidet suspendu monotrou (poids 23 kg). L. 390 P. 550 H. 365 mm. Blanc brillant QSYBSC01; blanc mat QSYBSB01.  
/ Wand-Bidet, Einloch-Ausschnitt (Gewicht 23 kg). L. 390 P. 550 H. 365 mm. Weiß glänzend QSYBSC01; weiß matt QSYBSB01.  
/ Bidé suspendido un agujero (peso 23 kg). L. 390 P. 550 H. 365 mm. Blanco brillante QSYBSC01; blanco mate QSYBSB01.

/ Vaso sospeso (peso 23 kg). L. 390 P. 550 H. 365 mm. Bianco lucido QSYVSC01; bianco opaco QSYVSB01. Copriwater in resina termoindurente, cerniera con dispositivo di caduta rallentata. Bianco lucido AVHA003, bianco opaco AVHA004.  
/ Suspended toilet bowl (weight 23 kg). L. 390 P. 550 H. 365 mm. Polished white QSYVSC01; matt white QSYVSB01. Toilet seal in thermosetting resin, hinge with soft-closing mechanism. Polished white AVHA003; matt white AVHA004.  
/ WC suspendu (poids 23 kg). L. 390 P. 550 H. 365 mm. Blanc brillant QSYVSC01; blanc mat QSYVSB01. Couvercle en matériau thermoudrécissable, charnière avec mécanisme de retombée ralentie. Blanc brillant AVHA003; blanc mat AVHA004.

/ Wand-WC (Gewicht 23 kg). L. 390 P. 550 H. 365 mm. Weiß glänzend QSYVSC01; weiß matt QSYVSB01. WC-Sitz aus Duroplast, Scharnier mit Absenkautomatik. Weiß glänzend AVHA003; weiß matt AVHA004.  
/ Inodoro suspendido (peso 23 kg). L. 390 P. 550 H. 365 mm. Blanco brillante QSYVSC01; blanco mate QSYVSB01. Tapa para inodoro en resina termoindurecida, bisagra con dispositivo de caída amortiguada. Blanco brillante AVHA003; blanco mate AVHA004.

**Piatti, Cabine Doccia**  
Shower Trays, Shower Boxes

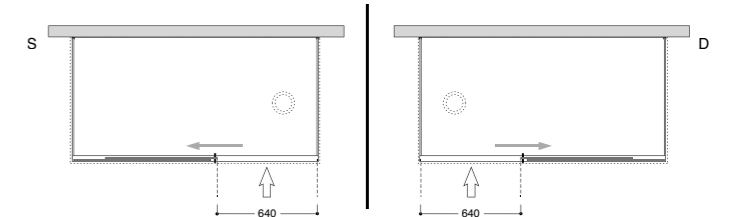
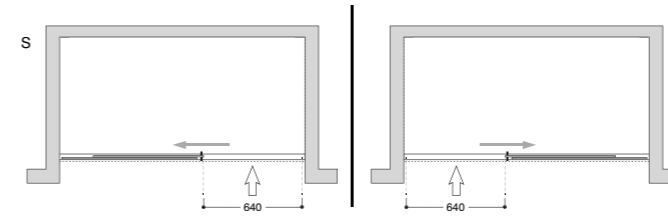
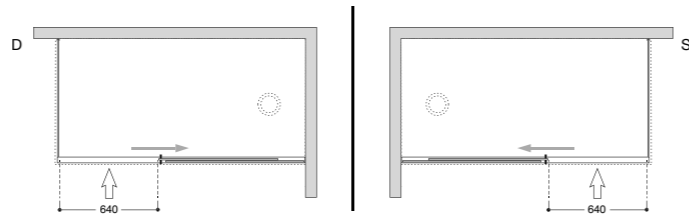
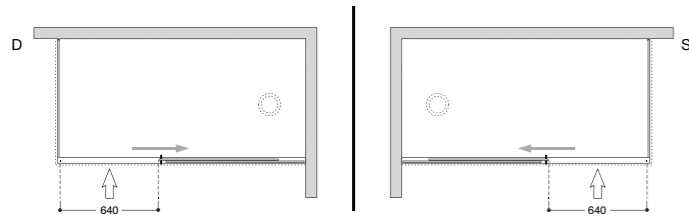
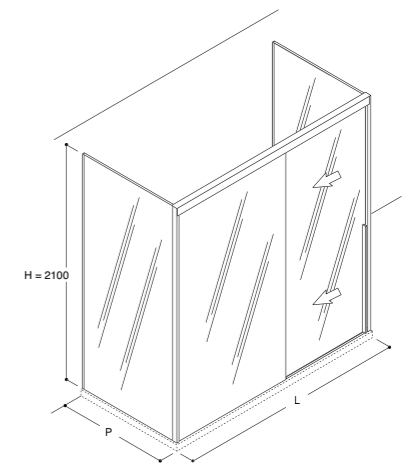
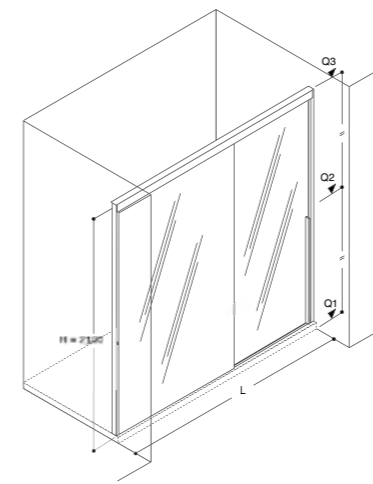
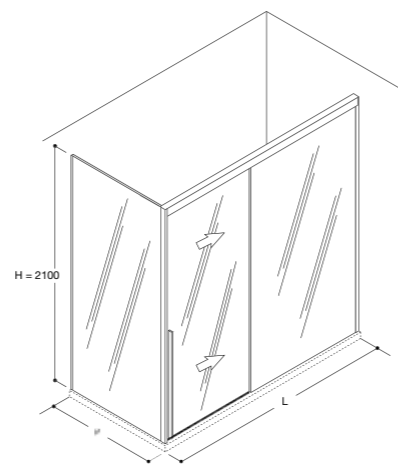
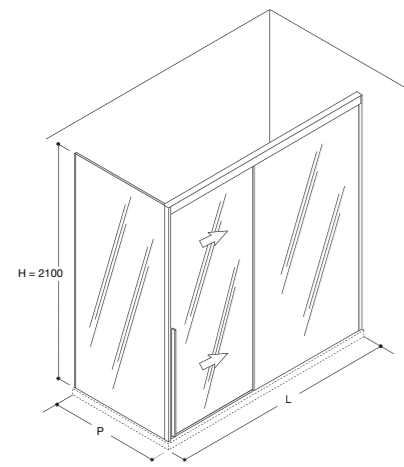

**Sliding**

/ Box doccia a misura cliente in vetro temperato, spessore 8 mm. Trattamento antigoccia. Profili e maniglia in alluminio anodizzato disponibile nelle varianti di finitura nero o inox. Varie configurazioni disponibili.  
/ Customised shower box in 8 mm. thick tempered glass. Crystal clear treatment (anti-drop treatment). Profiles and handle in anodised aluminium, available in black or stainless steel finishes. Different configurations available.  
/ Cabine de douche sur mesure Client en verre trempé, épaisseur 8 mm. Traitement anti-gouttes. Profils et poignée en aluminium anodisé disponible dans les variantes de finition noir ou inox. Différentes configurations disponibles.  
/ Duschkabine nach Kundenmaß aus gehärtetem Glas, Stärke 8 mm. Perleffekt-Beschichtung. Profile und Griff aus eloxiertem Aluminium verfügbar in den Ausführungen schwarz oder Edelstahl. Verschiedene Konfigurationen möglich.  
/ Cabina ducha a medida cliente en vidrio templado, de 8 mm de espesor. Tratamiento antical. Perfiles y tirador de aluminio anodizado disponible en las variantes de acabado negro o inox. Varias configuraciones disponibles.

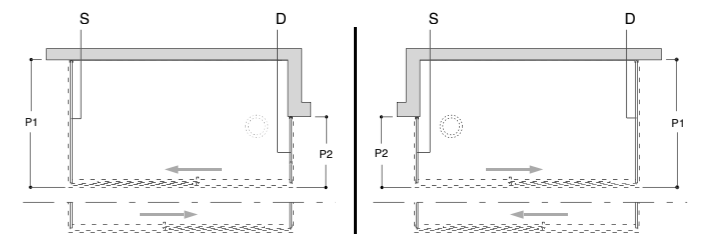
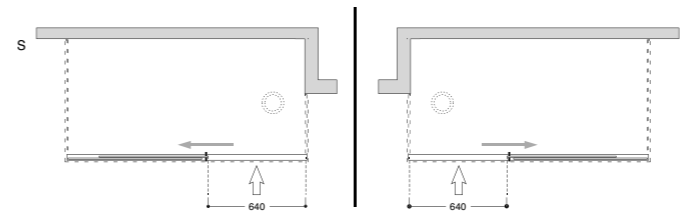
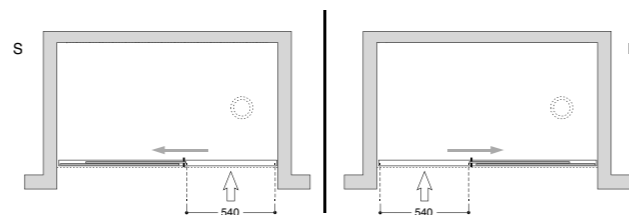
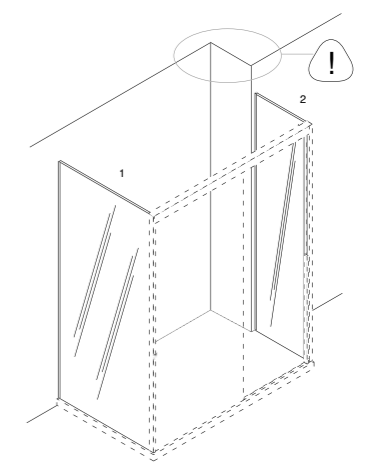
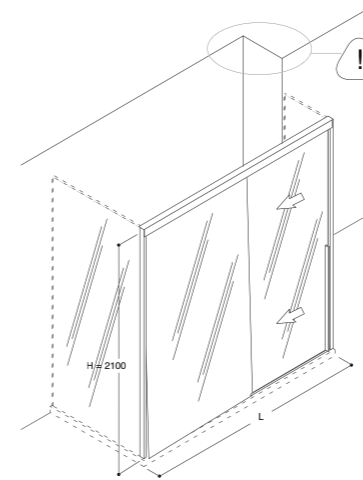
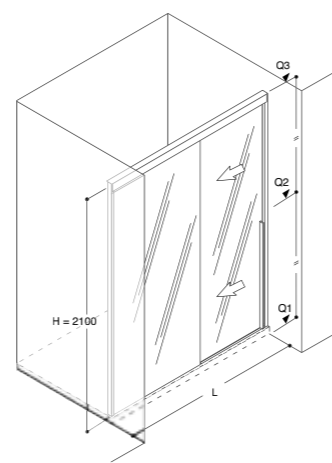

**Piatti, Cabine Doccia**  
Shower Trays, Shower Boxes

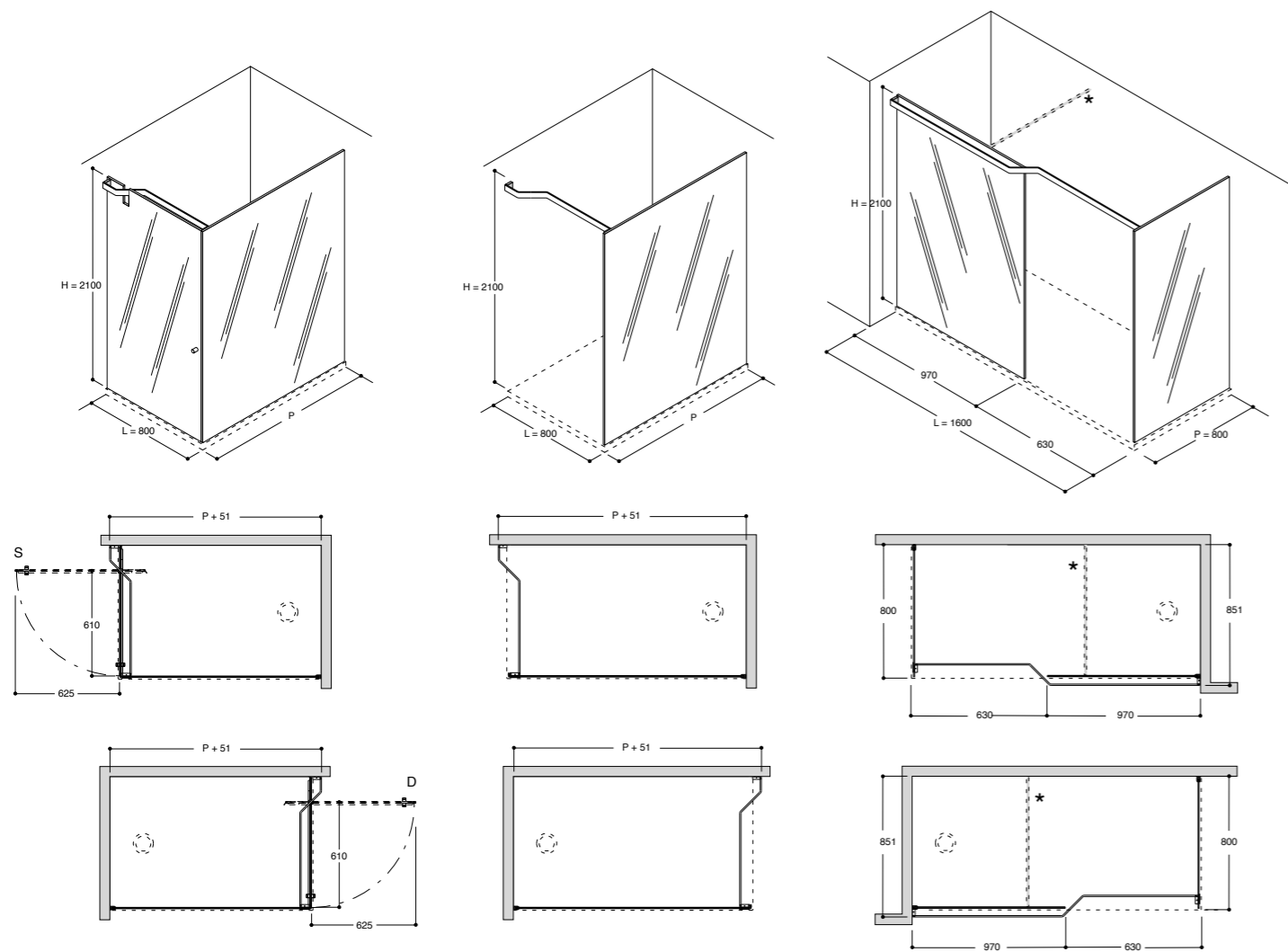

**Tape**

/ Piatto doccia in Ceramilux® bianco opaco, completo di piletta sifonata. A misura fissa (L. 800 / 900 - P. 800 / 1000 / 1200 / 1400 / 1600, H. 50 mm) o a misura cliente (L. 800 / 900, H. 50 mm, P. min. 800, max 1600 mm). Box doccia in vetro Extralight trasparente temperato, spessore 8 mm. Trattamento antigoccia. Barra sagomata di fissaggio in acciaio inox satinato. Varie configurazioni disponibili.

/ Shower tray made of matt white Ceramilux®, waste trap included. Fix-sized (L. 800 / 900 - P. 800 / 1000 / 1200 / 1400 / 1600, H. 50 mm) or customised shower trays (L. 800 / 900, H. 50 mm, P. min. 800, max 1600 mm). Shower box in 8 mm. thick Extralight transparent tempered glass. Crystal clear treatment (anti-drop treatment). Shaped fixed beam in satin stainless steel. Different configurations available.

/ Receveurs douche réalisé en Ceramilux® blanc mat. Muni de bonde avec siphon. Receveur de douche sur mesure fixe (L. 800 / 900 - P. 800 / 1000 / 1200 / 1400 / 1600, H. 50 mm) ou sur mesure client (L. 800 / 900, H. 50 mm, P. min. 800, max 1600 mm). Cabine de douche en verre Extralight transparent trempé, épaisseur 8 mm. Traitement anti-gouttes. Barre gabariée de fixation en acier inox satiné. Différentes configurations disponibles.

/ Duschwannen aus Ceramilux® mattweiß. Mit Ablaufventil und Syphon. Duschwanne mit Festmass (L. 800 / 900 - P. 800 / 1000 / 1200 / 1400 / 1600, H. 50 mm) oder nach Kundenmass (L. 800 / 900, H. 50 mm, P. mind. 800, max 1600 mm). Duschkabinen aus Extralight transparentem Hartglas, Stärke 8 mm. Perleffekt-Beschichtung Formgeschlittene Befestigungsstange. Verschiedene Konfigurationen möglich.

/ Plato de ducha realizado en Ceramilux® blanco mate. Equipado con válvula sifónica. Platos de ducha de medida fija (L. 800 / 900 - P. 800 / 1000 / 1200 / 1400 / 1600, H. 50 mm) o a medida cliente (L. 800 / 900, H. 50 mm, P. min. 800, max 1600 mm). Cabina de ducha en vidrio Extralight transparente templado, de 8 mm. de espesor. Tratamiento antical. Barra perfilada de fijación de acero inoxidable satinado. Varias configuraciones disponibles.

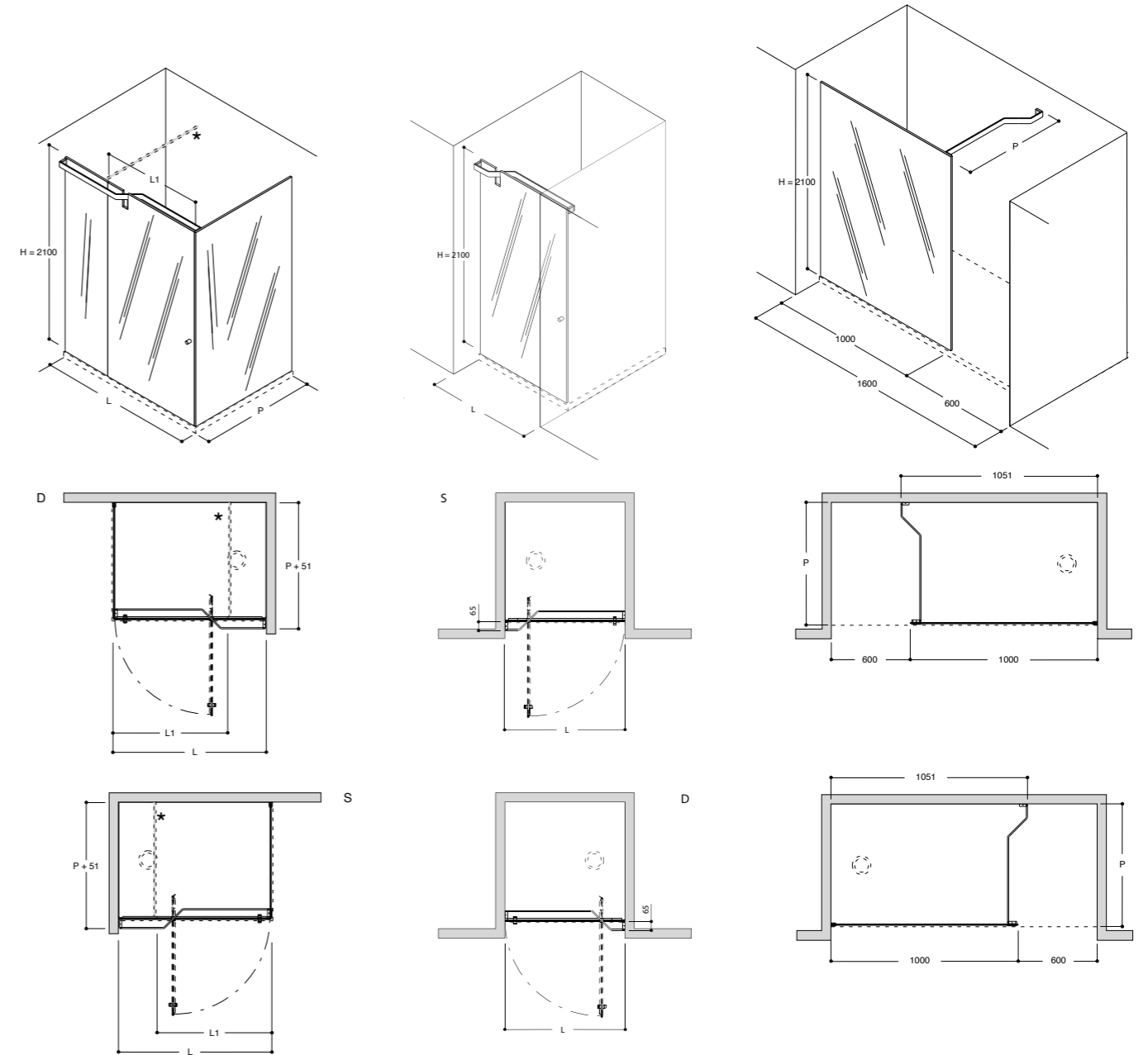

## Piatti, Cabine Doccia Shower Trays, Shower Boxes

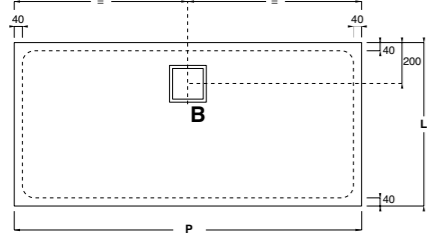
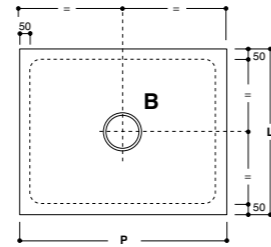
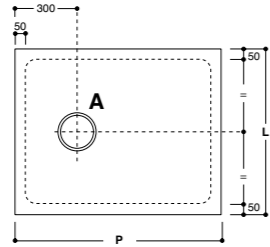
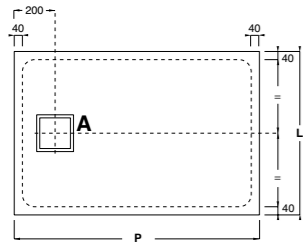

### Tape 18

/ Piatto doccia in Corian® bianco opaco, completo di piletta sifonata con copriscarico in Corian® bianco. E' possibile installare il piatto a filo pavimento. Scarico laterale o centrale. A misura fissa (L. 800/900 - P. 800/1000/1200/1400/1600, H. 50 mm) o a misura cliente (L. 800/900, H. 50 mm, P. min. 800, max 2500 mm). Piatto doccia in Ceramilux® finitura cemento (colori: bianco/nero). Completo di piletta sifonata (scarico continuo) con copriscarico in Ceramilux® finitura cemento (colori: bianco/nero). E' possibile installare il piatto a filo pavimento. Scarico laterale o centrale. A misura fissa (L. 800/900 - P. 800/1000/1200/1400/1600/1700/1800, H. 40 mm).

/ Shower tray made of matt white Corian®, waste trap included (free-flow), with cover in white Corian®. The shower tray can be installed flush with the floor. Drain laterally or central positioned. Fix-sized (L. 800/900 - P. 800/1000/1200/1400/1600, H. 50 mm) or customised shower trays (L. 800/900, H. 50 mm, P. min. 800, max 2500 mm).

Shower tray made of Ceramilux®, concrete finish (colours: white/black). Waste trap included (free-flow), with cover in Ceramilux®, concrete finish (colours: white/black). The shower tray can be installed flush with the floor. Drain laterally or central positioned. Fix-sized (L. 800/900 - P. 800/1000/1200/1400/1600/1700/1800, H. 40 mm).

/ Receveurs douche réalisé en Corian® blanc mat. Muni de siphon (écoulement continu) avec couverture en Corian® blanc. Il est possible d'installer le receveur au ras du sol. Ecoulement latéral ou central. Receveur de douche sur mesure fixe (L. 800/900 - P. 800/1000/1200/1400/1600, H. 50 mm) ou sur mesure client (L. 800/900, H. 50 mm, P. min. 800, max 2500 mm). Receveurs douche réalisé en Ceramilux® fini ciment (couleurs: blanc/noir). Muni de siphon (écoulement continu) avec couverture en fini ciment (couleurs: blanc/noir). Il est possible d'installer le receveur au ras du sol. Ecoulement latéral ou central. Receveur de douche sur mesure fixe (L. 800/900 - P. 800/1000/1200/1400/1600/1700/1800 H. 40 mm).

Receveur de douche sur mesure fixe (L. 800/900 - P. 800/1000/1200/1400/1600, H. 50 mm) ou sur mesure client (L. 800/900, H. 50 mm, P. min. 800, max 2500 mm). Receveurs douche réalisé en Ceramilux® fini ciment (couleurs: blanc/noir). Muni de siphon (écoulement continu) avec couverture en fini ciment (couleurs: blanc/noir). Il est possible d'installer le receveur au ras du sol. Ecoulement latéral ou central. Receveur de douche sur mesure fixe (L. 800/900 - P. 800/1000/1200/1400/1600/1700/1800 H. 40 mm).

/ Duschwannen aus Corian® mattweiß. Mit Ablaufgarnitur und Siphon (freilaufenden Ablauf), Abdeckung aus Corian® weiß. Die Duschwanne kann mit dem Boden flächenbündig installiert werden. Wasserablauf seitlich oder mittig. Duschwanne mit Festmass (L. 800/900 - P. 800/1000/1200/1400/1600, H. 50 mm) oder nach Kundenmass (L. 800/900, H. 50 mm, P. mind. 800, max 2500 mm). Duschwannen aus Ceramilux®, Ausführung Zement (Farben: weiß/schwarz). Mit Ablaufgarnitur und Siphon (freilaufenden Ablauf), Abdeckung aus Ceramilux®, Zement Ausführung (Farben: weiß / schwarz). Die Duschwanne kann mit dem Boden flächenbündig installiert werden. Wasserablauf seitlich oder mittig. Duschwanne mit Festmass (L. 800/900 - P. 800/1000/1200/1400/1600/1700/1800, H. 40 mm).

/ Plato de ducha realizado en Corian® blanco mate. Equipado con válvula sifónica (desagüe continuo) con cubre desagüe de Corian® blanco. Es posible instalar el plato a ras del suelo. Corte lateral o central. Platos de ducha de medida fija (L. 800/900 - P. 800/1000/1200/1400/1600, H. 50 mm) o a medida cliente (L. 800/900, H. 50 mm, P. min. 800, max 2500 mm). Plato de ducha realizado en Ceramilux® acabado cemento (colores: blanco/negro). Equipado con válvula sifónica (desagüe continuo) con cubre desagüe de Ceramilux® acabado cemento (colores: blanco/negro). Es posible instalar el plato a ras del suelo. Corte lateral o central. Platos de ducha de medida fija (L. 800/900 - P. 800/1000/1200/1400/1600/1700/1800, H. 40 mm).

## Rubinetti Taps

### Cut

/ Miscelatori in acciaio inox AISI 304, finitura satinata, con cartuccia ceramica progressiva. Portata d'acqua costante e temperatura regolabile. / Mixers in stainless steel AISI 304, satin finish, with progressive ceramic cartridge. Invariable water capacity and adjustable temperature. / Mélangeurs mitigeurs en acier inox AISI 304, finition satinée, avec cartouche en céramique progressive. Portée d'eau constante et température réglable. / Mischer aus Edelstahl AISI 304 satiniert, mit stufenregulierbarer Patrone aus Keramik, gleichbleibender Wasserzulauf und regulierbare Temperatur. / Griferia de acero inoxidable AISI 304 satinado, con cartucho cerámico progresivo. Caudal de agua constante y temperatura ajustable.

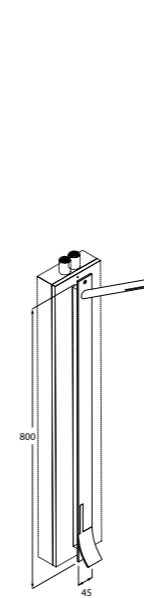

### Cut

/ Gruppo doccia, da incasso, montaggio verticale H. 800 mm, RECT05.  
/ Built-in shower tap, vertically assembled H. 800 mm, RECT05.  
/ Batterie de douche, à encastrer, montage vertical H. 800 mm, RECT05.  
/ Eingebaute Wandduschbrausebatterie, vertikale Montage H. 800 mm, RECT05.  
/ Mezclador ducha, empotrado a la pared H. 800 mm, RECT05.

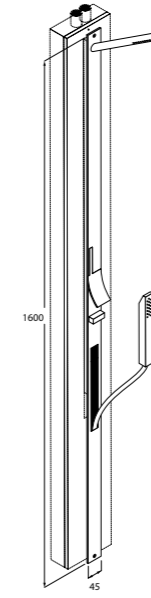

### Cut

/ Gruppo doccia e doccia da incasso con deviatore, montaggio verticale H. 1600 mm, RECT06.  
/ Built-in shower tap and hand-shower with diverter, vertically assembled H. 1600 mm, RECT06.  
/ Batterie douche et douchette à encastrer avec inverseur, montage vertical H. 1600 mm, RECT06.  
/ Eingebaute Wandduschbrausebatterie mit Handdusche und Wasserleitungsregler, vertikale Montage H. 1600 mm, RECT06.  
/ Grupo ducha, empotrado a la pared, compuesto por mezclador, boca, teleducha y desviador, H. 1600 mm, RECT06.

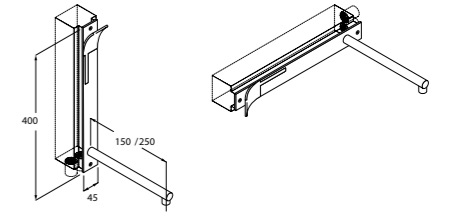

### Cut

/ Gruppo lavabo, da incasso, con bocca L. 150 mm, RECT01 / L. 250 mm, RECT02, montaggio orizzontale o verticale.  
/ Built-in tap system for washbasins, with spout L. 150 mm, RECT01 / L. 250 mm, RECT02, horizontally or vertically assembled.  
/ Batterie lavabo, à encastrer, avec bec L. 150 mm, RECT01 / L. 250 mm, RECT02, montage horizontal ou vertical.  
/ Wandeingebaute-Mischerbatterie für Waschbecken, mit Wasserhahn L. 150 mm, RECT01 / L. 250 mm, RECT02, horizontal oder vertikal montierbar.  
/ Mezclador lavabo, empotrado a la pared, boca L. 150 mm, RECT01 / L. 250 mm, RECT02, montaje horizontal o vertical.

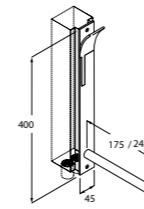

### Cut

/ Gruppo bidet, da incasso, con bocca L. 175 mm, RECT03 / L. 245 mm, RECT04, montaggio orizzontale o verticale.  
/ Built-in tap system for bidet, with spout L. 175 mm, RECT03 / L. 245 mm, RECT04, horizontally or vertically assembled.  
/ Batterie bidet, à encastrer, avec bec L. 175 mm, RECT03 / L. 245 mm, RECT04, montage horizontal ou vertical.  
/ Wandeingebaute-Mischerbatterie für Bidet, mit Wasserhahn L. 175 mm, RECT03 / L. 245 mm, RECT04, horizontal oder vertikal montierbar.  
/ Mezclador bidet, empotrado a la pared, boca L. 175 mm, RECT03 / L. 245 mm, RECT04, montaje horizontal o vertical.

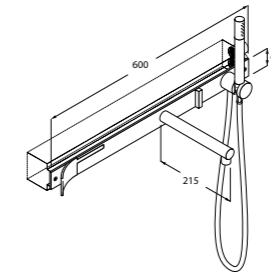
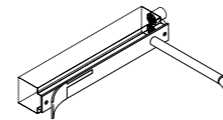

### Cut

/ Gruppo vasca, da incasso parete, composto da miscelatore, bocca, doccia e deviatore. RECT08.  
/ Built-in bathtub tap set consisting of spout + mixer + hand-shower + diverter. RECT08.  
/ Batterie baignoire, à installation murale, composée de mitigeur, bec, douchette et inverseur. RECT08.  
/ Wand-Armaturengruppe für Badewanne. Bestehend aus: Mischer, Wasserhahn, Brausekopf und Wasserlaufregler, RECT08.  
/ Grupo bañera, empotrado a la pared, compuesto por: mezclador, boca, teleducha y desviador. RECT08.

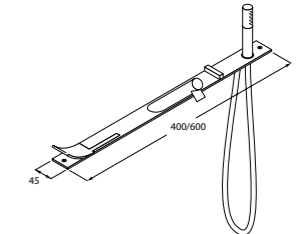

### Cut

/ Gruppo bordo vasca, composto da miscelatore, bocca, doccia e deviatore, L. 600 mm, RECT07. Gruppo bordo vasca erogazione al troppo pieno composto da miscelatore, doccia e deviatore L. 400 mm, RECT10.  
/ Deck-mounted spout + mixer + hand shower + diverter, L. 600 mm, RECT07. Deck-mounted mixer + handshower + diverter, with overflow-spout, L. 400 mm, RECT10.  
/ Batterie sur plage baignoire, composée de mitigeur, bec, douchette et inverseur, L. 600 mm, RECT07. Batterie sur plage baignoire avec débit au trop-plein composée de mitigeur, douchette, inverseur L. 400 mm, RECT10.  
/ Wannenrand-Armaturengruppe, bestehend aus: Mischer, Wasserhahn, Brausekopf und Wasserlaufregler, L. 600 mm, RECT07. Wannenrand-Armaturengruppe ohne Wasserhahn Spende am Überlauf bestehend aus: Mischer, Wasserhahn, Brausekopf und Wasserlaufregler L. 400 mm, RECT10.  
/ Grupo bañera, empotrado borde bañera, compuesto por: mezclador, boca, teleducha y desviador, L. 600 mm, RECT07. Grupo bañera, empotrado borde bañera. Sin boca, compuesto por: mezclador, boca, teleducha y desviador, L. 400 mm, RECT10.



## Rubinetti Taps

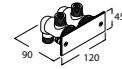

### Cut

/ Rubinetto d'arresto acqua calda e fredda, con filtri e valvole antiriflusso, RECT09.  
/ Shut-off valve for cold and hot water, with anti-water-reflux filters and valves, RECT09.  
/ Robinet d'arrêt eau chaude et froide, avec filtres et clapets de non-retour, RECT09.  
/ Warm-/Kaltwasser-Sperrventil, mit Filter und Rücklaufsperrventile, RECT09.  
/ Grifo de parada agua caliente y fría, equipado con filtros y válvulas antirretorno, RECT09.

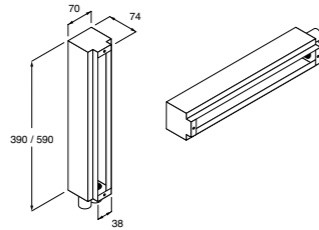

### Cut

/ Cassetta da incasso a muro, L. 400 mm, attacchi 1/2" per cod. RECT01/02/03/04, RRCT01, L. 600 mm. per RECT08, RRCT02.  
/ Recessed wall container for tap, L. 400 mm, 1/2" connection, for codes RECT01/02/03/04, - RRCT01, L. 600 for RECT08, RRCT02.  
/ Corps encastré mural, L. 400 mm, branchements 1/2" pour cod. RECT 01/02/03/04, RRCT01, L. 600 mm. pour cod. RECT08, RRCT02.  
/ Wand-Einbaukasten, L. 400 mm, Anschluß 1/2" für Code RECT01/02/03/04, RRCT01, L. 600 mm. für Code RECT08, RRCT02.  
/ Caja de empotrar a la pared, L. 400 mm, racores 1/2" para cod. RECT01/02/03/04, RRCT01, L. 600 mm. para cod. RECT08, RRCT02.

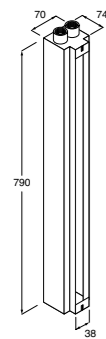

### Cut

/ Cassetta da incasso a muro, L. 1600 mm, attacchi 1/2" per cod. RECT06, caldo dx, freddo sx. RRCT04.  
/ Recessed wall container for tap, L. 1600 mm, 1/2" connection, for code RECT06, hot water on the right, cold water on the left. RRCT04.  
/ Corps encastré mural, L. 1600 mm, branchements 1/2" pour cod. RECT06, chaud droite, froid gauche. RRCT04.  
/ Wand-Einbaukasten, L. 1600 mm, Anschluß 1/2" für Code RECT06, warmes Wasser rechts und kaltes links. RRCT04.  
/ Caja de empotrar a la pared, L. 1600 mm, racores 1/2" para cod. RECT06, RRCT04.

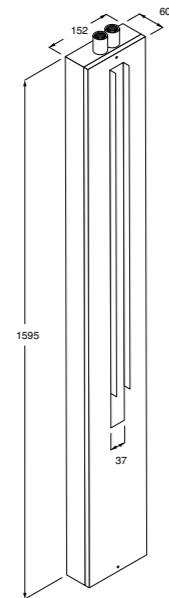

### Cut

/ Cassetta da incasso a muro, L. 800 mm, attacchi 1/2" per cod. RECT05, caldo dx, freddo sx. RRCT03.  
/ Recessed wall container for tap, L. 800 mm, 1/2" connection, for code RECT05, hot water on the right, cold water on the left. RRCT03.  
/ Corps encastré mural, L. 800 mm, branchements 1/2" pour cod. RECT05, chaud droite, froid gauche. RRCT03.  
/ Wand-Einbaukasten, L. 800 mm, Anschluß 1/2" für Code RECT05, warmes Wasser rechts und kaltes links. RRCT03.  
/ Caja de empotrar a la pared, L. 800 mm, racores 1/2" para cod. RECT05, RRCT03.

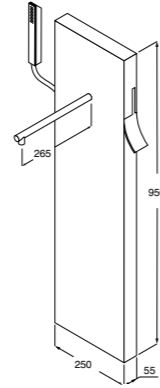

### Cut

/ Colonna pavimento per vasca, composta da miscelatore, deviatore, doccia manuale e bocca di erogazione L. 265 mm. RGCT01.  
/ Floor-mounted unit for bathtub, consisting of mixer, diverter, hand-shower, spout L. 265 mm. RGCT01.  
/ Colonne de sol pour baignoire, composée de un mitigeur, inverseur, et douchette à main et bec déverseur L. 265 mm. RGCT01.  
/ Bodenstand-Armaturengruppe für Badewannen, bestehend aus: Mischer, Wasserhahn, Brausekopf und Wasserlaufregler, L. 265 mm. RGCT01.  
/ Grupo bañera, de suelo, compuesto por: mezclador, boca, teleducha y desviador, L. 265 mm, RGCT01.

## Eclipse

/ Rubinetteria in acciaio inox AISI 304. Finitura satinata o grigio PVD. / Taps in stainless steel AISI 304. Finishes: satin or grey PVD. / Robinetterie en acier inox AISI 304. Finition: satinée ou gris PVD/ Armaturen aus Edelstahl AISI 304. Ausführungen: satiniert oder grau PVD/ Griferia de acero inoxidable AISI 304. Acabado: satinado o gris PVD.

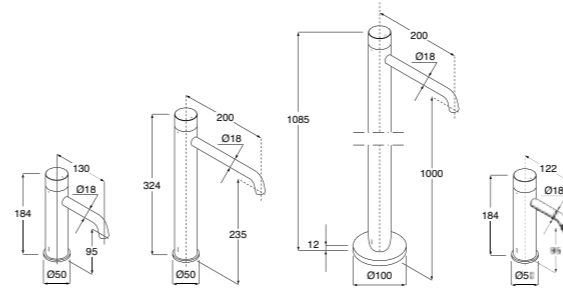

### Eclipse

/ Miscelatore lavabo, portata 5,7 l/min (3 bar), basso H.180 mm, inox satinato cod. RERX01, grigio PVD cod. RERX11. Alto H. 320 mm, inox satinato cod. RERX02, grigio PVD cod. RERX12. A pavimento H.1034 mm, inox satinato cod. RERX03, grigio PVD cod. RERX13.  
/ Mixer tap for washbasin, flow rate: 5,7 l/min (3 bar), short H.180 mm, satin stainless steel cod. RERX01, PVD grey cod. RERX11. Tall H. 320 mm, satin stainless steel cod. RERX02, PVD grey cod. RERX12. Free standing floor-mounted H. 1034 mm, satin stainless steel cod. RERX03, PVD grey cod. RERX13.  
/ Mitigeur lavabo, débit : 5,7 l/min (3 bars), bas H.180 mm, inox satiné cod. RERX01, gris PVD cod. RERX11. Haut H. 320 mm, inox satiné cod. RERX02, gris PVD cod. RERX12. Au sol H. 1034 mm, inox satiné cod. RERX03, gris PVD cod. RERX13.  
/ Mischer für Waschbecken, Durchflussmenge: 5,7 l/min (3 Bar), niedrig H.180 mm, Edelstahl satiniert Cod. RERX01, grau PVD Cod. RERX11. Hoch H. 320 mm, Edelstahl satiniert Cod. RERX02, grau PVD Cod. RERX12. Bodenstand H. 1034 mm, Edelstahl satiniert Cod. RERX03, grau PVD Cod. RERX13.  
/ Mezclador lavabo, caudal: 5,7 l/min (3 bar), bajo H.180 mm, inox satinado cod. RERX01, gris PVD cod. RERX11. Alto H. 320 mm, inox satinado cod. RERX02, gris PVD cod. RERX12. De suelo H. 1034 mm, inox satinado cod. RERX03, gris PVD cod. RERX13.

### Eclipse

/ Miscelatore bidet, portata 5,7 l/min (3 bar), H. 180 mm, inox satinato cod. RERX04, grigio PVD cod. RERX14.  
/ Mixer tap for bidet, flow rate: 5,7 l/min (3 bar), H. 180 mm, satin stainless steel cod. RERX04, PVD grey cod. RERX14.  
/ Mitigeur bidet, débit : 5,7 l/min (3 bars), H. 180 mm, inox satiné cod. RERX04, gris PVD cod. RERX14.  
/ Mischer für Bidet, Durchflussmenge: 5,7 l/min (3 Bar), H. 180 mm, Edelstahl satiniert Cod. RERX04, grau PVD Cod. RERX14.  
/ Mezclador bidé, caudal: 5,7 l/min (3 bar), H. 180 mm, inox satinado cod. RERX04, gris PVD cod. RERX14.

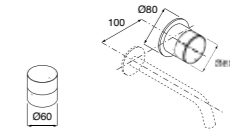

### Eclipse

/ Miscelatore lavabo, da piano, inox satinato cod. RERX05, grigio PVD cod. RERX15. A parete, inox satinato cod. RERX06, grigio PVD cod. RERX16.  
/ Top-mounted mixer tap for washbasin, satin stainless steel cod. RERX05, PVD grey cod. RERX15. Wall-mounted, satin stainless steel cod. RERX06, PVD grey cod. RERX16.  
/ Mitigeur lavabo, sur plan, inox satiné cod. RERX05, gris PVD cod. RERX15. Mural, inox satiné cod. RERX06, gris PVD cod. RERX16.  
/ Waschtisch-Mischer, Edelstahl satiniert Cod. RERX05, grau PVD Cod. RERX15. Wand-Mischer, Edelstahl satiniert Cod. RERX06, grau PVD Cod. RERX16.  
/ Mezclador lavabo, de encimera, inox satinado cod. RERX05, gris PVD cod. RERX15. De pared, inox satinado cod. RERX06, gris PVD cod. RERX16.

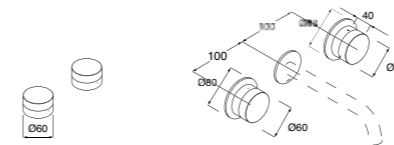

### Eclipse

/ Coppia rubinetti lavabo, da piano, inox satinato cod. RGRX01, grigio PVD cod. RGRX06. Incasso a parete, inox satinato cod. RGRX02, grigio PVD cod. RGRX07.  
/ Top-mounted tap pair for washbasin, satin stainless steel cod. RGRX01, PVD grey cod. RGRX06. Built-in wall-mounted, satin stainless steel cod. RGRX02, PVD grey cod. RGRX07.  
/ Couple robinets lavabo, sur plan, inox satiné cod. RGRX01, gris PVD cod. RGRX06. Encastrement mural, inox satiné cod. RGRX02, gris PVD cod. RGRX07.  
/ Zwei Drehgriffventile für Waschtisch, Edelstahl satiniert Cod. RGRX01, grau PVD Cod. RGRX06. Zwei Wand-Armaturen für Waschbecken, Cod. RGRX02, grau PVD Cod. RGRX07.  
/ Par de grifos lavabo, de encimera, inox satinado cod. RGRX01, gris PVD cod. RGRX06. Empotrados a la pared, inox satinado cod. RGRX02, gris PVD cod. RGRX07.

### Eclipse

/ Bocca lavabo, a parete, portata: 5,7 l/min (3 bar), P. 160 mm, inox satinato cod. RIRX01, grigio PVD cod. RIRX07. P. 230 mm, inox satinato cod. RIRX02, grigio PVD cod. RIRX08. Da piano, H. 170 mm, inox satinato cod. RIRX03, grigio PVD cod. RIRX09. H. 280 mm, inox satinato cod. RIRX04, grigio PVD cod. RIRX10.  
/ Wall-mounted spout for washbasin, flow rate: 5,7 l/min (3 bar), P. 160 mm, satin stainless steel cod. RIRX01, PVD grey cod. RIRX07. P. 230 mm, satin stainless steel cod. RIRX02, PVD grey cod. RIRX08. Top-mounted, H. 170 mm, satin stainless steel cod. RIRX03, PVD grey cod. RIRX09. H. 280 mm, satin stainless steel cod. RIRX04, PVD grey cod. RIRX10.  
/ Bec lavabo, mural, débit : 5,7 l/min (3 bars), P. 160 mm, inox satiné cod. RIRX01, gris PVD cod. RIRX07. P. 230 mm, inox satiné cod. RIRX02, gris PVD cod. RIRX08. Sur plan, H. 170 mm, inox satiné cod. RIRX03, gris PVD cod. RIRX09. H. 280 mm, inox satiné cod. RIRX04, gris PVD cod. RIRX10.  
/ Wand-Wasserhahn für Waschbecken, Durchflussmenge: 5,7 l/min (3 Bar), P. 160 mm, Edelstahl satiniert Cod. RIRX01, grau PVD Cod. RIRX07. P. 230 mm, Edelstahl satiniert Cod. RIRX02, grau PVD Cod. RIRX08. Für Waschtisch, H. 170 mm, Edelstahl satiniert Cod. RIRX03, grau PVD Cod. RIRX09. H. 280 mm, Edelstahl satiniert Cod. RIRX04, grau PVD Cod. RIRX10.  
/ Boca lavabo, de pared, caudal: 5,7 l/min (3 bar), P. 160 mm, inox satinado cod. RIRX01, gris PVD cod. RIRX07. P. 230 mm, inox satinado cod. RIRX02, gris PVD cod. RIRX08. De encimera, H. 170 mm, inox satinado cod. RIRX03, gris PVD cod. RIRX09. H. 280 mm, inox satinado cod. RIRX04, gris PVD cod. RIRX10.

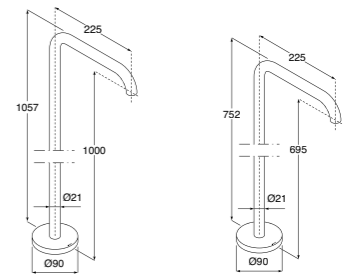

### Eclipse

/ Bocca lavabo, a pavimento, portata: 5,7 l/min (3 bar), H. 1057 mm, inox satinato cod. RIRX05, grigio PVD cod. RIRX11. Per vasca, portata: 24 l/min (3 bar), H. 752 mm, inox satinato cod. RIRX06, grigio PVD cod. RIRX12.  
/ Freestanding floor-mounted spout for washbasin, flow rate: 5,7 l/min (3 bar), H. 1057 mm, satin stainless steel cod. RIRX05, PVD grey cod. RIRX11. For bathtub, flow rate: 24 l/min (3 bar), H. 752 mm, satin stainless steel cod. RIRX06, PVD grey cod. RIRX12.  
/ Bec lavabo au sol, débit : 5,7 l/min (3 bars), H. 1057 mm, inox satiné cod. RIRX05, gris PVD cod. RIRX11. Pour baignoire débit: 24 l/min (3 bars), H. 752 mm, inox satiné cod. RIRX06, gris PVD cod. RIRX12.  
/ Bodenstand-Wasserhahn für Waschbecken, Durchflussmenge: 5,7 l/min (3 Bar), H. 1057 mm, Edelstahl satiniert Cod. RIRX05, grau PVD Cod. RIRX11. Für Badewanne, Durchflussmenge: 24 l/min (3 Bar), H. 752 mm, Edelstahl satiniert Cod. RIRX06, grau PVD Cod. RIRX12.  
/ Boca lavabo de suelo, caudal: 5,7 l/min (3 bar), H. 1057 mm, inox satinado cod. RIRX05, gris PVD cod. RIRX11. Por bañera, caudal: 24 l/min (3 bar), H. 752 mm, inox satinado cod. RIRX06, gris PVD cod. RIRX12.

## Rubineti Taps

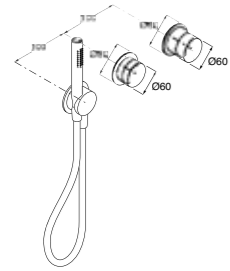

### Eclipse

/ Gruppo doccia/vasca, incasso a parete. Miscelatore monocomando, deviatore 2 vie, doccetta. Uso vasca: erogazione al troppopieno, inox satinato cod. RERX07, grigio PVD cod. RERX17.

/ Built-in wall-mounted shower/bathtub tap set. Single-lever mixer, 2-way diverter, hand shower. Bathtub use: water supply to overflow, satin stainless steel cod. RERX07, PVD grey cod. RERX17.

/ Batterie douche/baignoire, encastrement mural. Mitigeur monocommande, inverseur 3 voies, douchette. Utilisation baignoire : débit au trop-plein, inox satiné cod. RERX07, gris PVD cod. RERX17.

/ Wand-Armaturen für Badewanne und Dusche. Einhebelmischer, 2-Wege-Wasserlaufregler, Brausekopf. Für Badewanne: Wassereinlauf am Überlauf, Edelstahl satiniert Cod. RERX07, grau PVD Cod. RERX17.

/ Grupo ducha/bañera, empotrado a la pared. Mezclador monomando, desviador 2 vías, teleducha. Uso bañera: erogación al rebosadero, inox satinado cod. RERX07, gris PVD cod. RERX17.

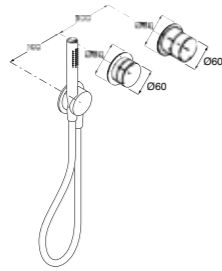

### Eclipse

/ Gruppo doccia, incasso a parete. Miscelatore monocomando, deviatore 3 vie, doccetta. Inox satinato cod. RERX08, grigio PVD cod. RERX18.

/ Built-in wall-mounted shower tap set. Single-lever mixer, 3-way diverter, hand shower. Satin stainless steel cod. RERX08, PVD grey cod. RERX18.

/ Batterie douche encastrement mural. Mitigeur monocommande, inverseur 3 voies, douchette. Inox satiné cod. RERX08, gris PVD cod. RERX18.

/ Wand-Armaturen für Dusche. Einhebelmischer, 3-Wege-Wasserlaufregler, Brausekopf. Edelstahl satiniert Cod. RERX08, grau PVD Cod. RERX18.

/ Grupo ducha, empotrado a la pared. Mezclador monomando, desviador 3 vías, teleducha. Inox satinado cod. RERX08, gris PVD cod. RERX18.

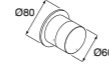

### Eclipse

/ Miscelatore lavabo/doccia, a parete, inox satinato cod. RERX10, grigio PVD cod. RERX20.

/ Wall-mounted mixer tap for washbasin/shower, satin stainless steel cod. RERX10, PVD grey cod. RERX20.

/ Mitigeur lavabo/douche, mural, inox satiné cod. RERX10, gris PVD cod. RERX20.

/ Wand-Mischer für Waschbecken/Dusche, Edelstahl satiniert Cod. RERX10, grau PVD Cod. RERX20.

/ Mezclador lavabo/ducha, de pared, inox satinado cod. RERX10, gris PVD cod. RERX20.

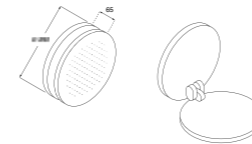

### Eclipse

/ Soffione doccia, a parete. Diametro 250 mm. Inox satinato cod. RRRX01, grigio PVD cod. RRRX03.

/ Wall-mounted shower head. Diameter: 250 mm. Satin stainless steel cod. RRRX01, PVD grey cod. RRRX03.

/ Pomme de douche, murale. Diamètre 250 mm. Inox satiné cod. RRRX01, gris PVD cod. RRRX03.

/ Duschbrausekopf. Durchmesser 250 mm. Edelstahl satiniert Cod. RRRX01, grau PVD Cod. RRRX03.

/ Cabezal de ducha, de pared. Diámetro 250 mm. Inox satinado cod. RRRX01, gris PVD cod. RRRX03.

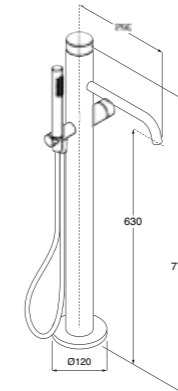

### Eclipse

/ Gruppo vasca, a pavimento. Miscelatore deviatore e doccetta, inox satinato cod. RERX09, grigio PVD cod. RERX19.

/ Freestanding floor-mounted bathtub tap set. Mixer, diverter and hand shower, satin stainless steel cod. RERX09, PVD grey cod. RERX19.

/ Batterie baignoire, au sol. Mitigeur, inverseur et douchette, inox satiné cod. RERX09, gris PVD cod. RERX19.

/ Bodenstand-Armaturengruppe für Badewanne. Mischer, Wasserlaufregler und Brausekopf, Edelstahl satiniert Cod. RERX09, grau PVD Cod. RERX19.

/ Grupo bañera, de suelo. Mezclador, desviador y teleducha, inox satinado cod. RERX09, gris PVD cod. RERX19.

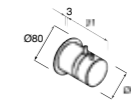

### Eclipse

/ Miscelatore termostatico, inox satinato cod. RHRX03, grigio PVD cod. RHRX07.

/ Thermostatic mixer tap, satin stainless steel cod. RHRX03, PVD grey cod. RHRX07.

/ Mitigeur thermostatique, inox satiné cod. RHRX03, gris PVD cod. RHRX07.

/ Thermostatmischer, Edelstahl satiniert Cod. RHRX03, grau PVD Cod. RHRX07.

/ Mezclador termoestático, inox satinado cod. RHRX03, gris PVD cod. RHRX07.

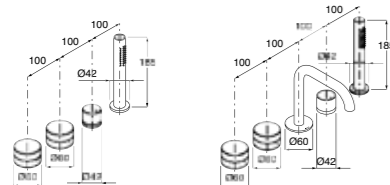

### Eclipse

/ Gruppo bordo vasca, incasso. Senza bocca. Rubineti caldo/freddo, doccetta con miscelatore dedicato, inox satinato cod. RGRX04, grigio PVD cod. RGRX09. Rubineti caldo/freddo, bocca, doccetta con miscelatore dedicato, inox satinato cod. RGRX03, grigio PVD cod. RGRX08.

/ Built-in deck-mounted tap set for bathtub. Without spout. Cold/warm taps, hand-shower with its mixer, satin stainless steel cod. RGRX04, PVD grey cod. RGRX09. Cold/ warm taps, spout, hand-shower with its mixer, satin stainless steel cod. RGRX03, PVD grey cod. RGRX08.

/ Batterie sur plage baignoire, encastrement. Sans bec. Robinets chaud / froid, douchette avec mitigeur dédié, inox satiné cod. RGRX04, gris PVD cod. RGRX09. Robinets chaud / froid, bec, douchette avec mitigeur dédié, inox satiné cod. RGRX03, gris PVD cod. RGRX08.

/ Wannenrand-Armaturen. Ohne Wasserhahn. Armaturen warm/kalt, Brause mit entsprechendem Mischer, Edelstahl satiniert Cod. RGRX04, grau PVD Cod. RGRX09. Armaturen warm/kalt, Wasserhahn, Brause mit entsprechendem Mischer, Edelstahl satiniert Cod. RGRX03, grau PVD Cod. RGRX08.

/ Grupo borde bañera, empotrado. Sin boca. Grifos caliente/frío, teleducha con mezclador específico, inox satinado cod. RGRX04, gris PVD cod. RGRX09. Grifos caliente/frío, boca, teleducha con mezclador específico, inox satinado cod. RGRX03, gris PVD cod. RGRX08.

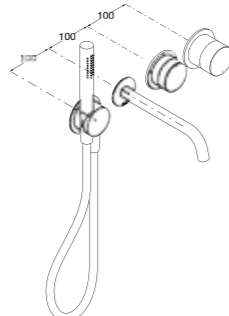

### Eclipse

/ Gruppo vasca, incasso a parete. Miscelatore, bocca, deviatore e doccetta, inox satinato cod. RGRX05, grigio PVD cod. RGRX10.

/ Built-in wall-mounted bathtub tap set. Mixer, spout, diverter and hand shower, satin stainless steel cod. RGRX05, PVD grey cod. RGRX10.

/ Batterie baignoire, encastrement mural. Mitigeur, bec, inverseur et douchette, inox satiné cod. RGRX05, gris PVD cod. RGRX10.

/ Wandarmaturen für Badewanne. Mischer, Wasserhahn, Wasserlaufregler und Brausekopf, Edelstahl satiniert Cod. RGRX05, grau PVD Cod. RGRX10.

/ Grupo bañera, empotrado a la pared. Mezclador, boca, desviador y teleducha, inox satinado cod. RGRX05, gris PVD cod. RGRX10.

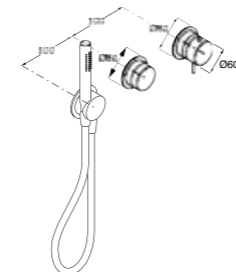

### Eclipse

/ Gruppo termostatico doccia, incasso a parete. Miscelatore termostatico, deviatore 2 vie, doccetta, inox satinato cod. RHRX01, grigio PVD cod. RHRX05. Deviatore 3 vie, inox satinato cod. RHRX02, grigio PVD cod. RHRX06.

/ Built-in wall-mounted shower thermostatic tap set. Thermostatic mixer, 2-way diverter, hand shower, satin stainless steel cod. RHRX01, PVD grey cod. RHRX05. 3-way diverter, satin stainless steel cod. RHRX02, PVD grey cod. RHRX06.

/ Groupe thermostatique douche, encastrement mural. Mitigeur thermostatique, inverseur 2 voies, douchette, inox satiné cod. RHRX01, gris PVD cod. RHRX05. Inverseur 3 voies, inox satiné cod. RHRX02, gris PVD cod. RHRX06.

/ Wand-Thermostatarmatur. Thermostatmischer, 2-Wege-Wasserlaufregler, Brausekopf, Edelstahl satiniert Cod. RHRX01, grau PVD Cod. RHRX05. 3-Wege-Wasserlaufregler, Edelstahl satiniert Cod. RHRX02, grau PVD Cod. RHRX06.

/ Grupo termostático ducha, empotrado a la pared. Mezclador termostático, desviador 2 vías, teleducha, inox satinado cod. RHRX01, gris PVD cod. RHRX05. Desviador 3 vías, inox satinado cod. RHRX02, gris PVD cod. RHRX06.

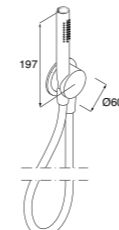

### Eclipse

/ Doccetta a parete, inox satinato cod. RJRX01, grigio PVD cod. RJRX02.

/ Wall-mounted hand-shower, satin stainless steel cod. RJRX01, PVD grey cod. RJRX02.

/ Douchette murale, inox satiné cod. RJRX01, gris PVD cod. RJRX02.

/ Wandbefestigte Handdusche, Edelstahl satiniert Cod. RJRX01, grau PVD Cod. RJRX02.

/ Teleducha de pared, inox satinado cod. RJRX01, gris PVD cod. RJRX02.

## Garden

/ Rubinetteria in acciaio inox AISI 304. Finitura satinata o grigio PVD. / Taps in stainless steel AISI 304. Finishes: satin or grey PVD. / Robinetterie en acier inox AISI 304. Finition: satinée ou gris PVD/ Armaturen aus Edelstahl AISI 304. Ausführungen: satiniert oder grau PVD/ Grifería de acero inoxidable AISI 304. Acabado: satinado o gris PVD.



## Garden

/ Miscelatore lavabo, da piano. Compatibile con tutte le bocche da piano o da parete. Cartuccia ceramica progressiva, apertura 90°. Cod. REGN01.  
/ Top-mounted mixer tap for washbasin. Compatible with all top - or wall-mounted spouts. Progressive ceramic cartridge, 90° opening. Cod. REGN01.  
/ Mitigeur lavabo, sur plan. Compatible avec tous les becs montés sur plan ou muraux. Cartouche céramique progressive, ouverture 90°. Cod. REGN01.  
/ Waschtisch-Mischer. Kompatibel mit allen Waschtisch- und Wandauslässen. Progressive Keramikkartusche, Öffnungswinkel 90°. Cod. REGN01.  
/ Mezclador lavabo, de encimera. Compatible con todas las bocas de encimera o de pared. Cartucho cerámico progresivo, apertura 90°. Cod. REGN01.

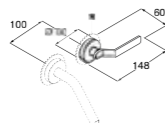

## Garden

/ Miscelatore lavabo, incasso a parete. Compatibile con tutte le bocche da parete. Cartuccia ceramica progressiva, apertura 90°. Parte esterna cod. REGN02E. Parte incasso cod. REGN02I.  
/ Wall-mounted, built-in washbasin mixer tap. Compatible with all wall-mounted spouts. Progressive ceramic cartridge, 90° opening. External part cod. REGN02E. Recessed part cod. REGN02I.  
/ Mitigeur lavabo, à encastrement mural. Compatible avec tous les becs montés muraux. Cartouche céramique progressive, ouverture 90°. Partie externe cod. REGN02E. Partie à encastrer cod. REGN02I.  
/ Wand-Mischer für Waschbecken. Kompatibel mit allen Wandauslässen. Progressive Keramikkartusche, Öffnungswinkel 90°. Außenliegender Teil Cod. REGN02E. Einbauteil Cod. REGN02I.  
/ Mezclador lavabo, empotrado a la pared. Compatible con todas las bocas de pared. Cartucho cerámico progresivo, apertura 90°. Parte exterior cod. REGN02E. Parte empotrado cod. REGN02I.

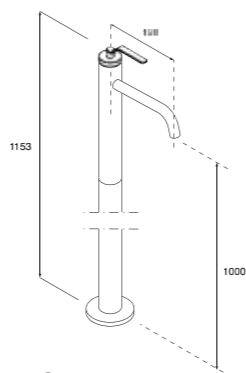

## Garden

/ Miscelatore lavabo, a pavimento. Cartuccia ceramica progressiva, apertura 90°. Cod. REGN03.  
/ Freestanding floor-mounted mixer tap for washbasin. Progressive ceramic cartridge, 90° opening. Cod. REGN03.  
/ Mitigeur lavabo, au sol. Cartouche céramique progressive, ouverture 90°. Cod. REGN03.  
/ Bodenstandmischer für Waschbecken. Progressive Keramikkartusche, Öffnungswinkel 90°. Cod. REGN03.  
/ Mezclador lavabo, de suelo. Cartucho cerámico progresivo, apertura 90°. Cod. REGN03.

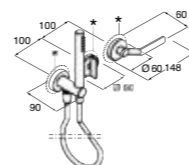

## Garden

/ Gruppo doccia/vasca, incasso a parete. Miscelatore con cartuccia progressiva 90°, deviatore 2 vie, doccia. Uso vasca: erogazione al troppopieno. Parte esterna cod. RGGN03E. Parte incasso cod. RGGN03I.  
/ Wall-mounted, built-in tap set for shower/bathtub. Mixer tap with 90° progressive cartridge, 2-way diverter and hand-shower. Bathtub use: water supply to overflow. External part cod. RGGN03E. Recessed part cod. RGGN03I.  
/ Batterie douche/plage baignoire, à encastrement mural. Mitigeur avec cartouche progressive 90°, inverseur 2 voies, douche. Utilisation baignoire : remplissage par trop-plein. Partie externe cod. RGGN03E. Partie à encastrer cod. RGGN03I.  
/ Wand-Armaturen für Badewanne und Dusche. Mischer mit progressiver Kartusche 90°, 2-Wege-Wasserlaufregler, Handbrause. Für Badewanne: Wassereinlauf am Überlauf. Außenliegender Teil Cod. RGGN03E. Einbauteil Cod. RGGN03I.  
/ Grupo ducha/bañera, empotrado a la pared. Mezclador con cartucho progresivo 90°, desviador 2 vías, teleducha. Uso bañera: erogación al rebosadero. Parte exterior cod. RGGN03E. Parte empotrado cod. RGGN03I.

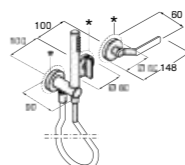

## Garden

/ Gruppo doccia, incasso a parete. Miscelatore con cartuccia progressiva 90°, deviatore 3 vie, doccia. Parte esterna cod. RGGN04E. Parte incasso cod. RGGN04I.  
/ Wall-mounted, built-in tap set for shower. Mixer tap with 90° progressive cartridge, 3-way diverter and hand-shower. External part cod. RGGN04E. Recessed part cod. RGGN04I.  
/ Batterie douche, à encastrement mural. Mitigeur avec cartouche progressive 90°, inverseur 3 voies, douche. Partie externe cod. RGGN04E. Partie à encastrer cod. RGGN04I.  
/ Wand-Armaturen für Dusche. Mischer mit progressiver Kartusche 90°, 3-Wege-Wasserlaufregler, Handbrause. Außenliegender Teil Cod. RGGN04E. Einbauteil Cod. RGGN04I.  
/ Grupo ducha, empotrado a la pared. Mezclador con cartucho progresivo 90°, desviador 3 vías, teleducha. Parte exterior cod. RGGN04E. Parte empotrado cod. RGGN04I.

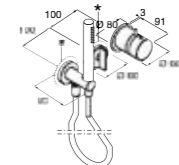

## Garden

/ Gruppo termostatico doccia, incasso a parete. Miscelatore termostatico, deviatore 2 vie, doccia. Parte esterna cod. RHGN02E. Parte incasso cod. RHGN02I. Deviatore 3 vie: parte esterna cod. RHGN03E. Parte incasso cod. RHGN03I.  
/ Wall-mounted, built-in thermostatic tap set for shower. Thermostatic mixer, 2-way diverter, hand-shower. External part cod. RHGN02E. Recessed part cod. RHGN02I. 3-way diverter: external part cod. RHGN03E. Recessed part cod. RHGN03I.  
/ Batterie thermostatique douche, encastrement mural. Mitigeur thermostatique, inverseur 2 voies, douche. Partie externe cod. RHGN02E. Partie à encastrer cod. RHGN02I. Inverseur 3 voies : partie externe cod. RHGN03E. Partie à encastrer cod. RHGN03I.  
/ Wand-Thermostatarmatur für Dusche. Thermostatmischer, 2-Wege-Wasserlaufregler, Handbrause. Außenliegender Teil Cod. RHGN02E. Einbauteil Cod. RHGN02I. 3-Wege-Wasserlaufregler: außenliegender Teil Cod. RHGN03E. Einbauteil Cod. RHGN03I.  
/ Grupo termoestático ducha, empotrado a la pared. Mezclador termoestático, desviador 2 vías, teleducha. Parte exterior cod. RHGN02E. Parte empotrado cod. RHGN02I. Desviador 3 vías: parte exterior cod. RHGN03E. Parte empotrado cod. RHGN03I.

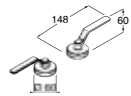

## Garden

/ Coppia rubinetti lavabo, da piano. Compatibile con tutte le bocche da piano o da parete. Vitoni ceramici da 1/2", apertura 90°. Cod. RGGN01. Incasso a parete: parte esterna cod. RGGN02E. Parte incasso cod. RGGN02I.  
/ Top-mounted tap pair for washbasin. Compatible with all top - or wall-mounted spouts. 1/2" ceramic screw disks, 90° opening. Cod. RGGN01. Built-in version: external part cod. RGGN02E. Recessed part cod. RGGN02I.  
/ Paire robinets lavabo, sur plan. Compatible avec tous les becs montés sur plan ou muraux. Vis céramiques de 1/2", ouverture 90°. Cod. RGGN01. A encastrement mural: partie externe cod. RGGN02E. Partie à encastrer cod. RGGN02I.  
/ Zwei Drehgriffventile für Waschtisch. Kompatibel mit allen Waschtisch- und Wandauslässen. Keramik-Drehscheiben 1/2", 90° Öffnung. Cod. RGGN01. Wandversion: Außenliegender Teil Cod. RGGN02E. Einbauteil Cod. RGGN02I.  
/ Par grifos lavabo, de encimera. Compatible con todas las bocas de encimera o de pared. Monturas cerámicas de 1/2", apertura 90°. Empotrados a la pared: parte exterior cod. RGGN02E. Parte empotrado cod. RGGN02I.

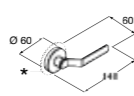

## Garden

/ Miscelatore lavabo/bidet/doccia, incasso a parete. Compatibile con tutte le bocche da piano o da parete. Cartuccia ceramica progressiva, apertura 90°. Parte esterna cod. REGN04E. Parte incasso cod. REGN04I.  
/ Wall-mounted, built-in mixer tap for washbasin/bidet/shower. Compatible with all top - or wall-mounted spouts. Progressive ceramic cartridge, 90° opening. External part cod. REGN04E. Recessed part cod. REGN04I.  
/ Mitigeur lavabo/bidet/douche, à encastrement mural. Compatible avec tous les becs montés sur plan ou muraux. Cartouche céramique progressive, ouverture 90°. Partie externe cod. REGN04E. Partie à encastrer cod. REGN04I.  
/ Wand-Mischer für Waschbecken/Bidet/Dusche. Kompatibel mit allen Waschtisch- und Wandauslässen. Kompatibel mit allen wandmontierten Brauseköpfen und Handbrausen. Progressive Keramikkartusche, Öffnungswinkel 90°. Außenliegender Teil Cod. REGN04E. Einbauteil Cod. REGN04I.  
/ Mezclador lavabo/bidet/ducha, empotrado a la pared. Compatible con todas las bocas de encimera o de pared. Compatible con todos los cabezales y las teleduchas de pared. Cartucho cerámico progresivo, apertura 90°. Parte exterior cod. REGN04E. Parte empotrado cod. REGN04I.

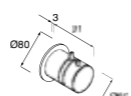

## Garden

/ Miscelatore termostatico, incasso a parete. Parte esterna cod. REGN06E. Parte incasso cod. RHRX03I.  
/ Wall-mounted, built-in thermostatic mixer tap. External part cod. REGN06E. Recessed part cod. RHRX03I.  
/ Mitigeur thermostatique, à encastrement mural. Partie externe cod. REGN06E. Partie à encastrer cod. RHRX03I.  
/ Thermostatmischer für Wandmontage. Außenliegender Teil Cod. REGN06E. Einbauteil Cod. RHRX03I.  
/ Mezclador termostático, empotrado a la pared. Parte exterior cod. REGN06E. Parte empotrado cod. RHRX03I.

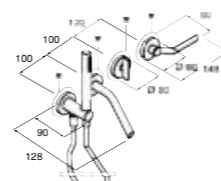

## Garden

/ Gruppo vasca, incasso a parete. Miscelatore con cartuccia progressiva 90°, bocca, deviatore e doccia. Parte esterna cod. RGGN07E. Parte incasso cod. RGGN07I.  
/ Wall-mounted, built-in tap set for bathtub. Mixer tap with 90° progressive cartridge, spout, diverter and hand-shower. External part cod. RGGN07E. Recessed part cod. RGGN07I.  
/ Batterie baignoire, à encastrement mura. Mitigeur avec cartouche progressive 90°, bec, inverseur et douche. Partie externe cod. RGGN07E. Partie à encastrer cod. RGGN07I.  
/ Wand-Armaturen für Badewanne. Mischer mit progressiver Kartusche 90°, Wasserhahn, Wasserlaufregler und Handbrause. Außenliegender Teil Cod. RGGN07E. Einbauteil Cod. RGGN07I.  
/ Grupo bañera, empotrado a la pared. Mezclador con cartucho progresivo 90°, boca, desviador y teleducha. Parte exterior cod. RGGN07E. Parte empotrado cod. RGGN07I.

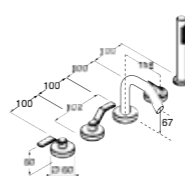

## Garden

/ Gruppo bordo vasca, incasso. Rubinetti freddo/caldo, bocca, doccia con miscelatore dedicato. Vitoni ceramici da 1/2", apertura 90°. Cod. RGGN05. Senza bocca Cod. RGGN06.  
/ Built-in deck-mounted tap set for bathtub. Cold/warm taps, spout, hand-shower with its mixer. 1/2" ceramic screw disks, 90° opening. Code RGGN05. Without spout Cod. RGGN06.  
/ Batterie plage baignoire, à encastrement. Robinets froid/chaud, bec, douche avec mitigeur dédié. Vis céramiques de 1/2", ouverture 90°. Code RGGN05. Sans bec Cod. RGGN06.  
/ Wannenrand-Armaturengruppe. Drehgriffventile kalt/warm, Wasserhahn, Handbrause mit separatem Mischer. Keramik-Drehscheiben 1/2", 90° Öffnung. Code RGGN05. Ohne Wasserhahn Cod. RGGN06.  
/ Grupo borde bañera, empotrado. Grifos frío/caliente, boca, teleducha con mezclador dedicado. Monturas cerámicas de 1/2", apertura 90°. Code RGGN05. Sin boca Cod. RGGN06.

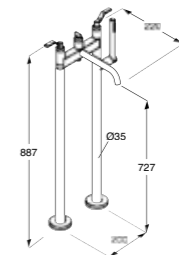

## Garden

/ Gruppo vasca, a pavimento. Rubinetti freddo/caldo, bocca, deviatore, doccia. Vitoni ceramici da 1/2", apertura 90°. Cod. RGGN08.  
/ Freestanding floor-mounted bathtub tap set. Cold/warm taps, spout, diverter, hand-shower. 1/2" ceramic screw disks, 90° opening. Cod. RGGN08.  
/ Batterie baignoire, fixée au sol. Robinets froid / chaud, bec, inverseur, douche. Vis céramiques de 1/2", ouverture 90°. Cod. RGGN08.  
/ Bodenstand-Armaturengruppe für Badewanne. Drehgriffventile kalt/warm, Wasserhahn, Wasserlaufregler, Handbrause. Keramik-Drehscheiben 1/2", 90° Öffnung. Cod. RGGN08.  
/ Grupo bañera, de suelo. Grifos frío / caliente, boca, desviador teleducha. Monturas cerámicas de 1/2", apertura 90°. Cod. RGGN08.

## Rubinetti Taps

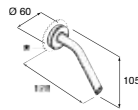

### Garden

/ Bocca lavabo/bidet/vasca, a parete. P. 128 mm cod. RIGN01.  
/ Wall-mounted spout for washbasin/bidet/bathtub. P. 128 mm cod. RIGN01.  
/ Bec lavabo/bidet/baignoire, mural. P. 128 mm cod. RIGN01.  
/ Wand-Wasserhahn für Waschbecken/Bidet/Badewanne. P. 128 mm cod. RIGN01.  
/ Boca lavabo/bidet/bañera, de pared. P. 128 mm cod. RIGN01.

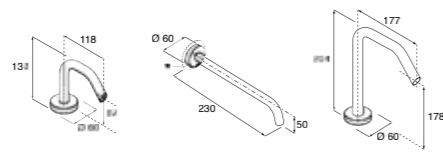

### Garden

/ Bocca lavabo, a parete. P. 230 mm cod. RIGN02. Da piano, H. 133 mm cod. RIGN03; H. 264 mm cod. RIGN04.  
/ Wall-mounted spout for washbasin. P. 230 mm cod. RIGN02. Top-mounted version, H. 133 mm cod. RIGN03; H. 264 mm cod. RIGN04.  
/ Bec lavabo, mural. P. 230 mm cod. RIGN02. Sur plan, H. 133 mm cod. RIGN03; H. 264 mm cod. RIGN04.  
/ Wand-Wasserhahn für Waschbecken. P. 230 mm cod. RIGN02. Wasserhahn für Waschtisch, H. 133 mm cod. RIGN03; H. 264 mm cod. RIGN04.  
/ Boca lavabo, de pared. P. 230 mm cod. RIGN02. De encimera, H. 133 mm cod. RIGN03; H. 264 mm cod. RIGN04.

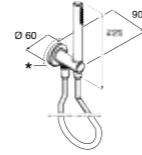

### Garden

/ Doccetta, a parete. Completa di flessibile L. 1500 mm e presa acqua. Cod. RJGN01.  
/ Wall-mounted hand shower. With 1500 mm long hose and water connection. Cod. RJGN01.  
/ Douchette murale. Munie de flexible L. 1500 mm et prise d'eau. Cod. RJGN01.  
/ Wandbefestigte Handdusche. Mit flexiblem Anschlussschlauch L. 1500 mm und Wasseranschluss. Cod. RJGN01.  
/ Teleducha, de pared. Equipada con flexo L. 1500 mm y toma de agua. Cod. RJGN01.

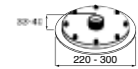

### Garden

/ Soffione doccia. Membrana anticalcare in silicone. Ø 220 cod. RFGN01. Ø 300 snodato cod. RFGN02.  
/ Shower head. Anti-limestone membrane in silicone. Ø 220 cod. RFGN01. Ø 300 articulated cod. RFGN02.  
/ Pomme douche. Membrane anticalcaire en silicone. Ø 220 cod. RFGN01. Ø 300 avec articulation cod. RFGN02.  
/ Duschbrausekopf. Antikalk-Silikonmembran. Ø 220 Cod. RFGN01. Ø 300 schwenkbar Cod. RFGN02.  
/ Cabezal de ducha. Membrana antical de silicona. Ø 220 cod. RFGN01. Ø 300 articulado cod. RFGN02.

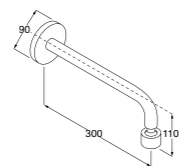

### Garden

/ Braccio per soffione doccia, a parete. Raccordo 1/2". Cod. RRRGN02. A soffitto cod. RRRGN03.  
/ Shower arm. 1/2" connection. Cod. RRRGN02. Ceiling connection for shower head cod. RRRGN03.  
/ Bras mural pour pomme douche. Raccord 1/2". Cod. RRRGN02. Au plafond cod. RRRGN03.  
/ Halterungsarm für Duschbrausekopf. Anschluss 1/2". Cod. RRRGN02. Deckenhalterung Cod. RRRGN03.  
/ Brazo para cabezal de ducha, de pared. Racor 1/2". Cod. RRRGN02. De techo cod. RRRGN03.

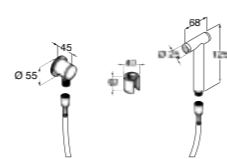

### Garden

/ Idroscopino, a parete. Raccordo 1/2". Completa di flessibile L. 1200 mm e presa acqua. Cod. RRRGN04.  
/ Wall-mounted toilet shower. 1/2" connection. With 1200 mm long hose and water connection. Cod. RRRGN04.  
/ Hydro-balai mural. Raccord 1/2". Munie de flexible L. 1200 mm et prise d'eau. Cod. RRRGN04.  
/ Wandbefestigter Wassersprayer. Anschluss 1/2". Mit flexiblem Anschlussschlauch L. 1200 mm und Wasseranschluss. Cod. RRRGN04.  
/ Hidroescobilla, de pared. Racor 1/2". Equipada con flexo L. 1200 mm y toma de agua. Cod. RRRGN04.

## Liquid

/ Rubinetteria in ottone cromato. / Taps in chromium-plated brass. / Robinetterie en laiton chromé. / Armaturen aus Messing verchromt. / Grifería de latón cromado.

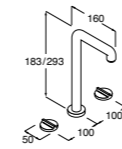

### Liquid

/ Gruppo 3 fori da piano, per lavabo, bocca alta RGSL01 - bocca bassa, vitone ceramico 90° da 1/2" RGSL02. Senza comando di scarico. Gruppo 3 fori, per bidet, senza comando di scarico, vitone ceramico 90° da 1/2" RGSL03.  
/ 3 drilled holes for top wash-basins, tall spout RGSL01 - short spout, 1/2" ceramic screw-disk 90° RGSL02. Without pop-up. 3 drilled holes for bidet, without pop-up, 1/2" ceramic screw-disk 90°. RGSL03.  
/ Batterie 3 trous, pour lavabo, bec grand RGSL01 - bec petit RGSL02. Sans commande d'évacuation, vis en céramique 90° de 1/2". Batterie 3 trous pour bidet, sans commande d'évacuation, vis en céramique 90° de 1/2". RGSL03.  
/ 3-Loch-Armaturen für Waschbecken, hoher Wasserhahn, RGSL01 - tiefer Wasserhahn, Drehscheibe aus Keramik 90°, 1/2" RGSL02. Ohne Ablaufregler. Dreiloch-Batterie für Bidet, ohne Ablaufregler-Drehscheibe aus Keramik 90°, 1/2". RGSL03.  
/ Grupo 3 agujeros lavabo, boca H. 293 mm. RGSL01 - boca H. 183 mm, RGSL02. Montura cerámica 90° de 1/2", sin desagüe. Grupo 3 agujeros bidet, sin desagüe, montura cerámica 90° de 1/2", RGSL03.

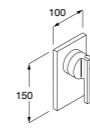
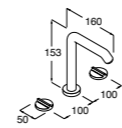

### Liquid

/ Miscelatore da incasso, per vasca e doccia, attacchi 1/2". Parte incasso RESL04I, esterna RESL04E.  
/ Built-in mixer for bathtub and shower, 1/2" connections. Recessed part, RESL04I, external RESL04E.  
/ Mitigeur à encastrer, pour baignoire et douche, branchements 1/2". Partie à encastrer RESL04I, externe RESL04E.  
/ Wand- Mischer für Badewanne/Dusche, Anschluß 1/2". Einbauteil RESL04I, Außenteil, RESL04E.  
/ Mezclador bañera / ducha, empotrado a la pared, racor 1/2". Parte empotrado RESL04I, parte externa RESL04E.

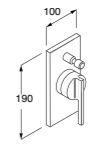

### Liquid

/ Miscelatore, da incasso, per vasca e doccia, con deviatore, attacchi 1/2". Parte incasso RESL05I, esterna RESL05E.  
/ Built-in mixer for bathtub and shower, with diverter, 1/2" connections. Recessed part, RESL05I, external RESL05E.  
/ Mitigeur à encastrer, pour baignoire et douche, avec inverseur, branchements 1/2". Partie à encastrer RESL05I, externe RESL05E.  
/ Wand- Mischer für Badewanne/Dusche mit Wasserlaufregler, Anschluß 1/2". Einbauteil RESL05I, Außenteil, RESL05E.  
/ Mezclador bañera/ducha, empotrado a la pared, con desviador, racores 1/2". Parte empotrado RESL05I, parte externa RESL05E.

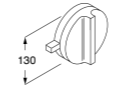

### Liquid

/ Miscelatore termostatico, da incasso, per vasca e doccia. Parte incasso RESL06I, esterna RESL06E.  
/ Built-in thermostatic mixer, for bathtub and shower. Recessed part, RESL06I, external RESL06E.  
/ Mitigeur thermostatique, à encastrer, pour baignoire et douche. Partie à encastrer RESL06I, externe RESL06E.  
/ Wandthermostatmischer für Badewanne/Dusche. Einbauteil RESL06I, Außenteil, RESL06E.  
/ Mezclador termoestático bañera/ducha, empotrado a la pared. Parte empotrado RESL06I, parte externa RESL06E.

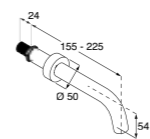

### Liquid

/ Bocca erogazione per vasca e lavabo, Ø 50 mm, attacco 1/2" L. 150 mm. RISL01 / L. 220 mm. RISL02.  
/ Spout for bathtub and washbasin, Ø 50 mm, 1/2" connection, L. 150 mm. RISL01 / L. 220 mm. RISL02.  
/ Bec déverseur pour baignoire et lavabo, Ø 50 mm, branchement 1/2" L. 150 mm. RISL01 / L. 220 mm. RISL02.  
/ Wand- Wasserhahn für Badewanne/Waschbecken Ø 50 mm, Anschluß 1/2", L. 150 mm. RISL01 / L. 220 mm. RISL02.  
/ Boca bañera/lavabo, de pared Ø 50 mm, racor 1/2". L. 150 mm. RISL01 / L. 220 mm. RISL02.

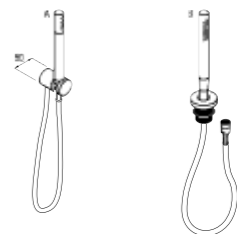

### Liquid

/ Doccetta a muro con membrana anticalcare in silicone e flessibile L. 1500 mm, attacco 1/2" (A) RJSL01. Doccetta bordo vasca con membrana anticalcare in silicone e flessibile L. 1500 mm, attacco 1/2" (B) RJSL02.  
/ Wall-mounted spray hand-shower with silicone anti-limestone membrane and hose L. 1500 mm, 1/2" connection (A) RJSL01. Flush-mounted spray hand-shower with silicone anti-limestone membrane and hose L. 1500 mm, 1/2" connection (B) RJSL02.  
/ Douchette murale avec membrane anti-calcaire en silicone et flexible L. 1500 mm, branchement 1/2" (A) RJSL01. Douchette pour plage de baignoire avec membrane anti-calcaire en silicone et flexible L. 1500 mm, branchement 1/2" (B) RJSL02.  
/ Wandhandbrause mit Antikalk-Silikonmembran und flexibler Anschlussschlauch L. 1500 mm, Anschluss 1/2" (A) RJSL01. Handbrause für Wannenrandmontage mit Antikalk-Silikonmembran und flexibler Anschlussschlauch L. 1500 mm, Anschluss 1/2" (B) RJSL02.  
/ Teleducha de pared con membrana antical de silicona y flexo L. 1500 mm. Racor 1/2", (A) RJSL01. Teleducha a borde bañera membrana antical de silicona y flexo L. 1500 mm. Racor 1/2", (B) RJSL02.

## Rubinetti Taps

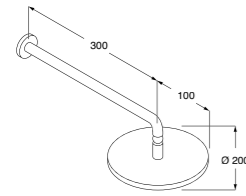

### Liquid

/ Soffione doccia Ø 200 mm, con membrana anticalcare in silicone e tubo di attacco 1/2" RFSL01.  
/ Ø 200 mm. shower plate, with silicone antilimestone membrane and 1/2" connection RFSL01.  
/ Pomme de douche Ø 200 mm, avec membrane anti-calcaire en silicone et tuyau de branchement 1/2" RFSL01.  
/ Duschbrausekopf Ø 200 mm, mit Antikalk-Silikonmembran und Anschluss 1/2" RFSL01.  
/ Cabezal de ducha Ø 200 mm, con membrana antical de silicona y racor 1/2" RFSL01.

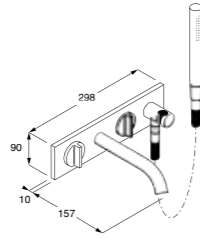

### Liquid

/ Gruppo vasca incasso parete composta da miscelatore, bocca di erogazione, doccino, deviatore e cartuccia progressiva. Parte incasso RESL07I, esterna RESL07E.  
/ Wall-mounted and built-in tap for bathtub composed by mixer, spout, hand-shower, diverter (progressive cartridge). Recessed part, RESL07I, external RESL07E.  
/ Batterie baignoire à installation murale composée de mélangeur, bec déverseur, douchette, inverseur (cartouche en céramique progressive). Partie à encastrer RESL07I, externe RESL07E.  
/ Wand-Armaturen für Badewanne mit Mischer, Wasserhahn, Brausekopf und Wasserlaufregler (mit stufenregulierbarer Kartusche). Einbauteil RESL07I, Außenteil, RESL07E.  
/ Grupo bañera, empotrado a la pared, Compuesto por: mezclador, boca, teleducha y desviador, Cartucho progresivo. Parte empotrado RESL07I, parte externa RESL07E.

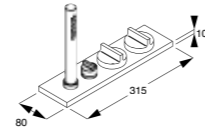

### Liquid

/ Gruppo bordo vasca erogazione al troppopieno composto da viti 3/4" caldo/freddo grande portata, doccetta manuale comandata da miscelatore. RESL09.  
/ Deck-mounted tap group, water supply to overflow, composed with 3/4" screw disks, cold/hot water, large water supply, hand-shower controlled by the mixer. RESL09.  
/ Batterie pour plage baignoire, montée sur plaque, composée de vis 3/4", eaux froide/chaude, haut débit, bec déverseur et douchette à main commandés par un mitigeur. RESL09.  
/ Wannenrand-Armaturen. Ohne Wasserhahn. Kalt-/Warmwasser-Armaturen mit Drehscheiben 3/4". Handbrause mit entsprechendem Mischer. RESL09.  
/ Grupo borde bañera, empotrado. Sin boca. Grifos frío/caliente con monturas 3/4". Teleducha con mezclador específico. RESL09.

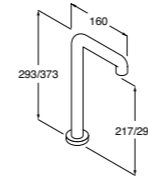

### Liquid

/ Bocca da piano, per lavabo, Ø 26 mm, raccordo 3/8" (Utilizzabile con RESL10) H. 293 mm. RISL04. H. 373 mm. RISL05.  
/ Spout for wash-basin, for counter top mounting, Ø 26 mm, 3/8" connection (to be used with RESL10) H. 293 mm. RISL04. H. 373 mm. RISL05.  
/ Bec plan, pour lavabo, Ø 26 mm, branchement 3/8" (à utiliser avec RESL10) H. 293 mm. RISL04. H. 373 mm. RISL05.  
/ Wasserhahn für Waschtisch, für Waschbecken, Ø 26 mm, Anschlußschläuche 3/8" (Kombinierbar mit Code RESL10). H. 293 mm. RISL04. H. 373 mm. RISL05.  
/ Boca lavabo, de encimera, Ø 26 mm, racor 3/8". Compatible con RESL10. H. 293 mm. RISL04. H. 373 mm. RISL05.

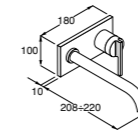

### Liquid

/ Miscelatore da incasso, a parete, per lavabo. Parte incasso RESL11I, esterna RESL11E.  
/ Built-in mixer for washbasin. Recessed part, RESL11I, external RESL11E.  
/ Mitigeur à encastrement mural, pour lavabo. Partie à encastrer RESL11I, externe RESL11E.  
/ Wand-Mischer für Waschbecken, für Waschbecken. Einbauteil RESL11I, Außenteil, RESL11E.  
/ Mezclador lavabo, empotrado a la pared. Parte empotrada RESL11I, parte externa RESL11E.

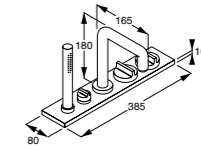

### Liquid

/ Gruppo vasca composta da viti 3/4", caldo/freddo, grande portata, bocca erogazione e doccetta manuale comandata da miscelatore. RGSL08.  
/ Deck-mounted group composed with 3/4" screw disks, cold/hot water, large water supply, spout and hand-shower controlled by the mixer. RGSL08.  
/ Batterie pour plage baignoire, montée sur plaque, composée de vis 3/4", eau froide/chaude, trop-plein haut débit, bec déverseur et douchette à main commandés par un mitigeur. RGSL08.  
/ Fertigset zur 4-Locharmatur für Wannenrandmontage Ausgestattet mit Drehscheiben 3/4", Kalt/Warmwasser, große Wassermenge, Handdusche und Mischer. RGSL08.  
/ Grupo borde bañera, empotrado. Grifos frío/caliente con monturas 3/4". RGSL08.

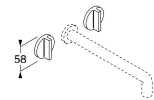

### Liquid

/ Gruppo due rubinetti incasso parete, caldo/freddo, uso lavabo (abbinamento con cod. RISL01-2) e uso doccia (abbinamento con cod. RFSL01). RGSL07.  
/ 2 wall-mounted and built-in taps, hot/cold water, for washbasin (to be matched with codes RISL01-2) and shower (to be matched with code RFSL01). RGSL07.  
/ Batterie deux robinets encastrement parois, chaude/froide, pour lavabo (à utiliser avec code RISL01-2) pour douche (à utiliser avec code RFSL01). RGSL07.  
/ 2er-Wandarmaturen für Waschbecken kaltes/warmes Wasser (kombinierbar mit Code RISL01-2) und für Dusche (kombinierbar mit Code RFSL01). RGSL07.  
/ Par grifos, de pared. Uso lavabo: compatibles con RISL01-02. Uso ducha: compatibles con RFSL01. RGSL07.



### Liquid

/ Deviatore da incasso a 3 vie. Parte incasso RVSL01I, esterna RVSL01E.  
/ 3-way built-in diverter. Recessed part, RVSL01I, external RVSL01E.  
/ Inverseur à encastrement à 3 voies. Partie à encastrer RVSL01I, externe RVSL01E.  
/ 3-Weg-Einbau-Wasserlaufregler. Einbauteil RVSL01I, Außenteil, RVSL01E.  
/ Desviador de 3 vías, empotrado a la pared. Parte empotrada RVSL01I, parte externa RVSL01E.

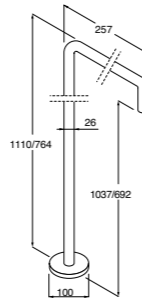

### Liquid

/ Bocca da terra per lavabo, attacco 1/2". H. 1110 mm. RISL03. Per vasca H. 764 mm. RISL06.  
/ Fixed floor-spout for wash-basin, 1/2" connection. H. 1110 mm. RISL03. For bathtub H. 764 mm. RISL06.  
/ Bec fixe au sol pour lavabo, branchement 1/2". H. 1110 mm. RISL03. Pour baignoire H. 764 mm. RISL06.  
/ Bodenstand-Wasserhahn für Waschbecken, Anschluss 1/2". H. 1110 mm. RISL03. Für Badewanne H. 764 mm. RISL06.  
/ Boca, de suelo lavabo, H. 1110 mm. RISL03. Para bañera H. 764 mm. RISL06.

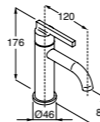

### Liquid

/ Miscelatore monocomando basso per lavabo, senza comando di scarico RESL12. Miscelatore monocomando basso per bidet, senza comando di scarico RESL13.  
/ Short mixer for washbasin, without pop-up RESL12. Short mixer for bidet, without pop-up RESL13.  
/ Mitigeur à une seule commande bas pour lavabo, sans commande de vidange RESL12. Mitigeur à une seule commande bas pour bidet, sans commande de vidange RESL13.  
/ Niedriger Einhebelmischer für Waschbecken, ohne Ablaufventilregler RESL12. Niedriger Einhebelmischer für Bidet, ohne Ablaufventilregler RESL13.  
/ Mezclador lavabo, sin desagüe RESL12. Mezclador bidet, sin desagüe RESL13.

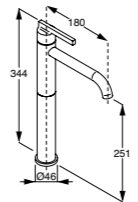

### Liquid

/ Miscelatore monocomando alto per lavabo, senza comando di scarico RESL14.  
/ Long mixer for washbasin, without pop-up RESL14.  
/ Mitigeur à une seule commande haute pour lavabo, sans commande de vidange RESL14.  
/ Hoher Einhebelmischer, für Waschbecken, ohne Ablaufventilregler RESL14.  
/ Mezclador lavabo alto, sin desagüe RESL14.

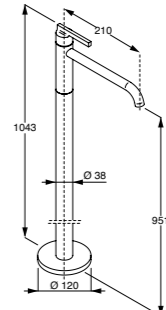

### Liquid

/ Miscelatore monocomando da terra per lavabo, senza comando di scarico RESL15.  
/ Floor-mounted mixer for washbasin, without pop-up RESL15.  
/ Mitigeur à une seule commande haute pour lavabo, sans commande de vidange RESL15.  
/ Bodenstand-Mischer für Waschbecken, ohne Ablaufregler RESL15.  
/ Mezclador lavabo, de suelo, sin desagüe RESL15.



## Rubinetti Taps

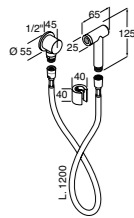

### Minimal

/ Idroscopino con possibilità di trasformazione in doccetta mediante ugello in dotazione. Flessibile inox L. 1200 mm, attacco 1/2". Finitura satinata RRDM10, finitura lucida RRDM09.

/ Toilet shower which can be used converted into hand-shower through issued nozzle. With shower hose in stainless steel L. 1200 mm, 1/2" connection. Satinised finish RRDM10, polished finish RRDM09.

/ Douchette pour WC avec possibilité de transformation en douchette. Avec flexible inox L. 1200 mm, branchement 1/2". Finition mat RRDM10, finition poli RRDM09.

/ Wassersprayer ausgestattet mit einer Düse für die Umwandlung in Handbrause, mit flexiblem Wasseranschlußschlauch L. 1200 mm, Anschluß 1/2". Ausführung satiniert RRDM10, Ausführung poliert RRDM09.

/ Hidroescobilla, de pared, se suministra boquilla para transformación en teleducha. Equipada con flexo L. 1200 mm. y toma de agua, racor 1/2". Satinado RRDM10, brillante RRDM09.

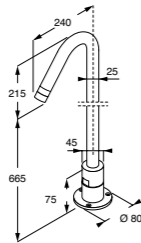

### Minimal

/ Bocca erogazione vasca, da terra. Attacco a terra 1/2", Ø 25 mm. (utilizzabile con RHDM01 / RHDM02 / REDM03). RIDM05.

/ Floor-spout for bathtub. 1/2" floor-connection, Ø 25 mm. (to be used with codes RHDM01 / RHDM02 / REDM03). RIDM05.

/ Bec baignoire, du sol, branchement au sol 1/2", Ø 25 mm. (à utiliser avec code RHDM01 / RHDM02 / REDM03). RIDM05.

/ Bodenbefestigter Wasserhahn für Badewanne Anschluß 1/2", Ø 25 mm. (verwendbar mit Code RHDM01 / RHDM02 / RHDM03). RIDM05.

/ Boca bañera, de suelo, racor 1/2", Ø 25 mm. (compatible con RHDM01 / RHDM02 / REDM03). RIDM05.

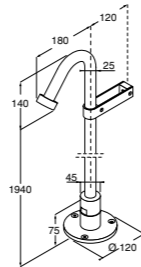

### Minimal

/ Bocca doccia da terra, attacco 1/2", Ø 25 mm. RFDM01.

/ Floor shower spout, 1/2" connection; Ø 25 mm. RFDM01.

/ Bras de douche au sol, branchement 1/2"; Ø 25 mm. RFDM01.

/ Bodenbefestigter Duschhahn, Anschluß 1/2", Ø 25 mm. RFDM01.

/ Boca ducha, de suelo racor 1/2", Ø 25 mm. RFDM01.

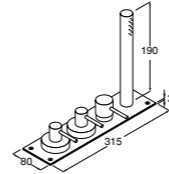

### Minimal

/ Gruppo bordo vasca, erogazione al troppopieno, montato su piastra, composto da vitoni 3/4", freddo/caldo, grande portata e doccetta manuale comandata da miscelatore. RGDM10.

/ Deck-mounted, positioned on plate, group, water supply to overflow, composed with 3/4" screw disks, cold/hot water, great water supply, hand-shower controlled by the mixer. RGDM10.

/ Batterie pour plage baignoire, montée sur plaque, composée de vis 3/4", eaux froide/chaude, débit au trop-plein haut débit, bec déverseur et douchette à main commandés par un mitigeur. RGDM10.

/ Wannenrand-Armaturengruppe, Versorgung/Spende am Überlauf, ausgestattet mit Drehscheiben 3/4", Kalt/Warmwasser, große Wassermenge und Handdusche, Mischer. RGDM10.

/ Grupo borde bañera, empotrado. Grifos frío/caliente con monturas 3/4". Teleducha con mezclador específico. RGDM10.

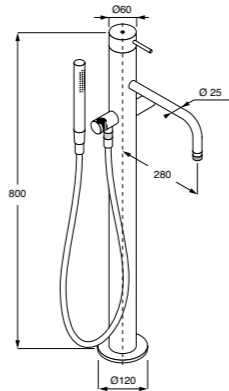

### Minimal

/ Gruppo vasca a pavimento. Composto da: miscelatore, bocca, doccetta e deviatore. Parte esterna REDM10E, parte incasso REDM10I.

/ Freestanding floor-mounted bathtub tap set. Consisting of: mixer, spout, hand shower and diverter. External part REDM10E, recessed part REDM10I.

/ Batterie baignoire fixée au sol. Composé de: mitigeur, bec, douchette et inverseur. Partie externe REDM10E, à encastrer REDM10I.

/ Bodenstand-Armaturengruppe für Badewanne Bestehend aus: Mischer, Wasserhahn, Handbrause und Wasserlaufregler. Außenteil REDM10E, Einbauteil REDM10I.

/ Grupo bañera de suelo. Compuesto por: mezclador, boca, teleducha y desviador. Parte externa REDM10E, parte empotrada REDM10I.



### Minimal

/ Miscelatore da piano per lavabo, con flessibili, raccordo 3/8". (Utilizzabile con RIDM03/04/10 da piano, RIDM06/07 da muro). REDM08.

/ Top-mounted mixer for washbasin, with hose, 3/8" connection (To be matched with RIDM03/04/10, top-mounted version, RIDM06/07 wall-mounted). REDM08.

/ Mitigeur pour plan lavabo, avec tuyaux flexibles, branchement 3/8" (à utiliser avec RIDM03/04/10 pour plan, RIDM06/07 mural). REDM08.

/ Waschtisch-Mischer, flexible Anschlußschläuche 3/8" (Kombinierbar mit Code RIDM03/04/10 am Waschtisch befestigt, RIDM06/07 an Wand befestigt). REDM08.

/ Mezclador lavabo, de encimera, con flexibles. Racor 3/8". Compatible con RIDM03/04/10 y RIDM06/07. REDM08.

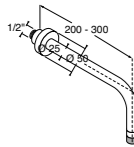

### \* Minimal

/ Bocca a muro, erogazione vasca, attacco 1/2", Ø 25 mm. con bocca L. 300 mm. RIDM01 / bocca L. 200 mm. RIDM02 (utilizzabile con cod. RHDM01 / RHDM02 / REDM03).

/ Wall-mounted spout for bathtub, 1/2" connection, Ø 25 mm, with spout L. 300 mm. RIDM01 / with spout L. 200 mm. RIDM02 (to be used with codes RHDM01 / RHDM02 / REDM03).

/ Bec a parois, pour baignoire, branchement 1/2"; Ø 25 mm, avec bec L. 300 mm. RIDM01 / avec bec L. 200 mm. RIDM02 (à utiliser avec cod. RHDM01 / RHDM02 / REDM03).

/ Wandwasserhahn, Auslauf für Badewanne Anschluß 1/2", Ø 25 mm. Wasserhahn L. 300 mm. RIDM01 / Wasserhahn L. 200 mm. RIDM02 (verwendbar mit Code RHDM01 / RHDM02 / REDM03).

/ Boca bañera, de pared, racor 1/2", Ø 25 mm, boca L. 300 mm. RIDM01 / boca L. 200 mm. RIDM02 (compatible con RHDM01 / RHDM02 / REDM03).

/

\* Disponibile fino ad esaurimento scorte  
Available until stock lasts



### Minimal

/ Miscelatore incasso per lavabo e doccia, Ø rosetta 100 mm. REDM03.

/ Built-in mixer for washbasins and showers, Ø 100 mm. washer. REDM03.

/ Mitigeur à encastrer pour lavabo et bidet, Ø rosace 100 mm. REDM03.

/ Wandeinbau-Mischer für Waschbecken und Dusche Ø Unterlagsscheibe 100 mm. REDM03.

/ Mezclador lavabo/ducha, de pared REDM03.

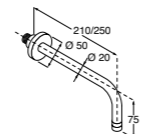

### Minimal

/ Bocca a muro erogazione lavabo, attacco da 1/2", Ø 20 mm. (utilizzabile con cod. REDM03); bocca L. 250 mm. RIDM06 / bocca L. 210 mm. RIDM07\*.

/ Wall-mounted spout for washbasins, 1/2" connection, Ø 20 mm, (to be used with cod. REDM03); spout, L. 250 mm. RIDM06 / spout L. 210 mm. RIDM07\*.

/ Bec déverseur mural pour lavabo, branchement 1/2", Ø 20 mm. (utilisable avec cod. REDM03); bec L. 250 mm. RIDM06 / bec L. 210 mm. RIDM07\*.

/ Wandbefestigter Wasserhahn für Waschbecken, Anschluß 1/2", Ø 20 mm. Kombinierbar mit Code REDM03 Wasserhahn L. 250 mm. RIDM06 / Wasserhahn L. 210 mm. RIDM07\*.

/ Boca lavabo, de pared, racor 1/2", Ø 20 mm, boca L. 250 mm. RIDM06 / boca L. 210 mm. RIDM07\* (compatible con REDM03).

/

\* RIDM07:  
Disponibile fino ad esaurimento scorte  
Available until stock lasts

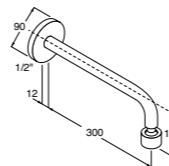

### Minimal

/ Braccio doccia, attacco 1/2", L. 300 mm. RRDM08.

/ Shower arm, 1/2" connection, W. 300 mm. RRDM08.

/ Bras de douche, branchement 1/2", L. 300 mm. RRDM08.

/ Halterungsarm für Duschbrausekopf, Anschluß 1/2", L. 300 mm. RRDM08.

/ Brazo para cabezal de ducha, de pared. Racor 1/2". RRDM08.



### Minimal

/ Presa acqua, attacco a parete 1/2" (Utilizzabile con cod. RIDM03/04/10). RRDM07.

/ Water connection, 1/2" wall connection (To be matched with codes RIDM03/04/10). RRDM07.

/ Prise d'eau, raccord mural 1/2" (à utiliser avec code RIDM03/04/10). RRDM07.

/ Wasseranschlussventil, Wandmontage 1/2" (Verwendbar mit Code RIDM03/04/10). RRDM07.

/ Toma agua, de pared, racor 1/2" (compatible con cod. RIDM03/04/10). RRDM07.

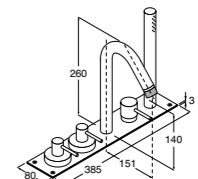

### Minimal

/ Gruppo bordo vasca, montato su piastra, composto da vitoni 3/4", freddo/caldo, grande portata, bocca di erogazione e doccetta manuale comandata da miscelatore. RGDM09.

/ Deck-mounted, positioned on plate, group composed with 3/4" screw disks, cold/hot water, great water supply, spout and hand-shower controlled by the mixer. RGDM09.

/ Batterie pour plage baignoire, montée sur plaque, composée de vis 3/4", eaux froide/chaude, débit au trop-plein haut débit, bec déverseur et douchette à main commandés par un mitigeur. RGDM09.

/ Wannenrand-Armaturengruppe, Versorgung/Spende am Überlauf, ausgestattet mit Drehscheiben 3/4", Kalt/Warmwasser, große Wassermenge und Handdusche, Mischer. RGDM09.

/ Grupo borde bañera, empotrado. Grifos frío/caliente con monturas 3/4". Teleducha con mezclador específico. RGDM09.

## Rubinetti Taps

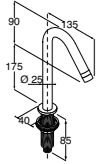

### \* Minimal

/ Bocca singola bordo vasca, attacco da 1/2", Ø 25 mm. RIDM08.  
/ Spout for deck-mounted tap, 1/2" connection, Ø 25 mm. RIDM08.  
/ Bec monté sur plage baignoire, branchement 1/2", Ø 25 mm. RIDM08.  
/ Einzelnr Wasserhahn auf Wannenrand montiert. Anschluß 1/2", Ø 25 mm. RIDM08.  
/ Boca bañera, a borde bañera, racor 1/2", Ø 25 mm. RIDM08.

/

\* Disponibile fino ad esaurimento scorte  
Available until stock lasts

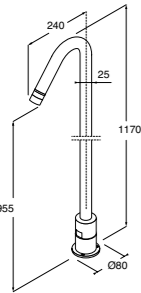

### Minimal

/ Bocca da terra per lavabo, attacco 1/2". RIDM09.  
/ Fixed floor-spout for washbasin, 1/2" connection. RIDM09.  
/ Bec fixe au sol pour lavabo, branchement 1/2". RIDM09.  
/ Bodenstand-Wasserhahn für Waschbecken, Anschluß 1/2". RIDM09.  
/ Boca lavabo, de suelo. Racor 1/2". RIDM09.

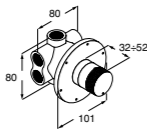

### Minimal

/ Deviatore da incasso a 5 vie attacco uscite 1/2". Parte incasso RVDM02I, parte esterna RVDM02E.  
/ 5-ways built-in diverter 1/2" connection. Recessed part RVDM02I, external RVDM02E.  
/ Inverseur à 5 voies à encastrer, branchement 1/2". Partie à encastrer, RVDM02I, partie externe RVDM02E.  
/ 5-Weg-Einbau-Wasserlaufregler, Anschlüsse 1/2" Einbauteil RVDM02I, Außenteil RVDM02E.  
/ Desviador de 5 vías, empotrado a la pared. Racores 1/2". Parte empotrado RVDM02I, externa RVDM02E.

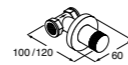

### Minimal

/ Rubinetto d'arresto generale, attacco 1/2", vitone ceramico. Parte incasso RGDM05I, parte esterna RGDM05E.  
/ Shut-off valve, ceramic screw-disk, 1/2" connection. Recessed part RGDM05I, external RGDM05E.  
/ Robinet d'arrêt général, cartouche à disque en céramique, branchement 1/2". RGDM05. Partie à encastrer, RGDM05I, partie externe RGDM05E.  
/ Wassersperrventil, Drehscheibe aus Keramik, Anschluß 1/2". Einbauteil RGDM05I, Außenteil RGDM05E.  
/ Grifo de parada agua. Montura cerámica. Racor 1/2". Parte empotrado RGDM05I, externa RGDM05E.

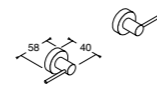

### Minimal

/ Gruppo due rubinetti incasso parete con vitoni ceramici apertura 90°, caldo/freddo, uso lavabo (abbinamento cod. RIDM03/04/06/07/09) e uso doccia (abbinamento cod. RFDM02 e RFDM01). Parte incasso RGDM08I, parte esterna RGDM08E.  
/ Wall-mounted, built-in tap pair with ceramic screw-disk 90°, hot/cold, for washbasin (to be used with cod. RIDM03/04/06/07/09) and for shower (to be used with cod. RFDM02 and RFDM01). Recessed part RGDM08I, external RGDM08E.  
/ Batterie robinetterie murale avec vis en céramique 90°, chaud/froid, pour lavabo (à utiliser avec code: RIDM03/04/06/07/09) et pour douche (à utiliser avec code: RFDM02 et RFDM01). Partie à encastrer, RGDM08I, partie externe RGDM08E.  
/ Gruppe bestehend aus zwei Einbau-Hebelgriffen mit Drehscheiben aus Keramik Öffnung 90°, Kalt/Warmwasser, für Waschbecken (kombinierbar mit Code RIDM03/04/06/07/09) für Dusche (kombinierbar mit Code RFDM02 und RFDM01). Einbauteil RGDM08I, Außenteil RGDM08E.  
/ Par de grifos, empotrado a la pared, monturas cerámicas con apertura a 90°. Uso lavabo: compatibles con RIDM03/04/06/07/09. Uso ducha: compatibles con RFDM01/02. Parte empotrado RGDM08I, externa RGDM08E.

/

\* Disponibile fino ad esaurimento scorte  
Available until stock lasts

## Pipe

/ Rubinetteria in acciaio inox AISI 304, finitura satinata con manopola rossa. / Taps in satin stainless steel AISI 304 with red handle. / Robinetterie en acier inox satiné AISI 304, avec poignée rouge. / Armaturen aus Edelstahl AISI 304 satiniert, mit Drehgriffe rot. / Grifería de acero inoxidable satinado AISI 304 con manija de color rojo.

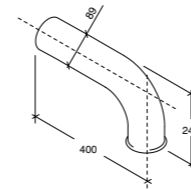

### Pipe

/ Doccia fissa a muro, completa di supporto di sostegno. Raccordo a parete 1/2". RFFP01.  
/ Fixed wall-mounted shower, provided with supporting part. 1/2" wall-connection. RFFP01.  
/ Douche fixe murale, avec support. Branchement mural 1/2". RFFP01.  
/ Wand-Wasserhahn für Dusche, ausgestattet mit Halterung, Wandanschluß 1/2". RFFP01.  
/ Boca ducha, de pared, Equipada con soporte de sujeción. Racor 1/2". RFFP01.

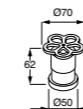

### Pipe

/ Miscelatore da piano per lavabo, con flessibile, maniglia rossa, raccordo 3/8" (Utilizzabile con RIDM03/04/10 da piano / RIDM06/07 da muro) REFP01.  
/ Top-mounted mixer for washbasin, with long hose, red handle, 3/8" connection (to be used with top-mounted RIDM03/04/10/wall-mounted RIDM06/07) REFP01.  
/ Mitigeur du dessus pour lavabo, avec flexible, poignée rouge, raccordement 3/8" (A utiliser avec RIDM03/04/10 pour dessus / RIDM06/07 à paroi) REFP01.  
/ Waschtisch-Mischer, mit flexiblem Anschlussschlauch, roter Drehgriff, Anschluß 3/8" (Kombinierbar mit RIDM03/04/10 Waschtisch, / RIDM06/07 Wand) REFP01.  
/ Mezclador lavabo, de encimera, con flexo, racor 3/8" (compatible con RIDM03/04/10 y RIDM06/07) REFP01.

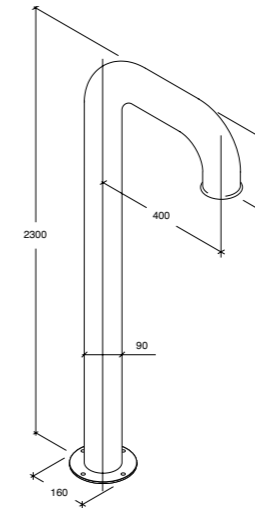

### Pipe

/ Doccia fissa da pavimento, completa di flangia e pozzetto. Raccordo a pavimento 1/2". RFFP02.  
/ Fixed floor-shower, provided with fixing flange and drain well. 1/2" floor connection. RFFP02.  
/ Douche fixe au sol, avec bride et regard. Branchement mural 1/2". RFFP02.  
/ Bodenstand-Wasserhahn für Dusche, ausgestattet mit Bodenhalterungen. Bodenanschluß 1/2". RFFP02.  
/ Boca ducha, de suelo, equipada con brida de fijación y sumidero. Racor 1/2". RFFP02.

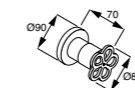

### Pipe

/ Miscelatore incasso per lavabo e doccia, con maniglia rossa REFP02.  
/ Built-in mixer for washbasin and shower, with red handle REFP02.  
/ Mitigeur à encastrement pour lavabo et douche, avec poignée rouge REFP02.  
/ Wand-Mischer für Waschbecken und Dusche, roter Drehgriff REFP02.  
/ Mezclador lavabo/ducha, de pared. REFP02.

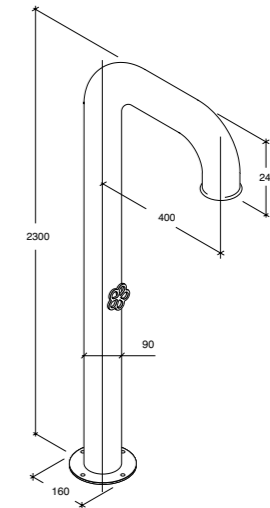

### Pipe

/ Doccia fissa da pavimento, con miscelatore a cartuccia ceramica progressiva maniglia rossa, completa di flangia e pozzetto. Raccordo a pavimento acqua calda/fredda da 1/2". RFFP03.  
/ Fixed floor-shower, with progressive ceramic cartridge mixer red handle, provided with fixing flange and drain well. 1/2" floor connection for hot/cold water. RFFP03.  
/ Douche fixe au sol, avec mélangeur à cartouche en céramique progressive poignée rouge, avec bride de fixation et regard. Branchement au sol eau chaude/froide de 1/2". RFFP03.  
/ Bodenstand-Wasserhahn mit Mischer für Dusche, mit stufenregulierbarer Kartusche aus Keramik, roter Drehgriff ausgestattet mit Bodenhalterungen. Kalt/Warmwasser Bodenanschluß 1/2". RFFP03.  
/ Boca con mezclador ducha, de suelo, con cartucho progresivo. Equipada con brida de fijación y sumidero. Racor 1/2". RFFP03.

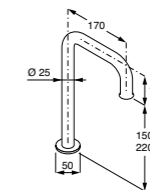

### Pipe

/ Bocca da piano, per lavabo e vasca H. 220 mm. RIFP01 / H. 290 mm. RIFP02.  
/ Spout, for counter top mounting, for washbasin and bathtub, H. 220 mm. RIFP01 / H. 290 mm. RIFP02.  
/ Bec monté sur plan, pour lavabo et baignoire, H. 220 mm. RIFP01 / H. 290 mm. RIFP02.  
/ Waschtisch-Wasserhahn für Waschbecken und Badewanne, H. 220 mm. RIFP01 / H. 290 mm. RIFP02.  
/ Boca lavabo/bañera, de encimera. H. 220 mm. RIFP01 / H. 290 mm. RIFP02.



## Rubinetti Taps

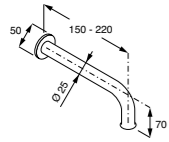

### Pipe

/ Bocca a muro, per lavabo e vasca, L. 150 mm. RIFP03, L. 220 mm. RIFP04.  
/ Wall-mounted spout for washbasin / bathtub L. 150 mm. RIFP03, L. 220 mm. RIFP04.  
/ Bec au mur, pour lavabo et baignoire L. 150 mm. RIFP03, L. 220 mm. RIFP04.  
/ Wasserhahn für Waschbecken/Badewanne L. 150 mm. RIFP03, L. 220 mm. RIFP04.  
/ Boca lavabo/bañera, de pared, L. 150 mm. RIFP03, L. 220 mm. RIFP04.

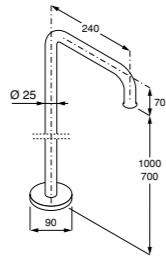

### Pipe

/ Bocca da terra, per lavabo H. 1070 mm. RIFP05. Bocca da terra, per vasca H. 770 mm. RIFP06.  
/ Floor-mounted spout for washbasin H. 1070 mm. RIFP05. Floor-mounted spout for bathtub. H. 770 mm. RIFP06.  
/ Bec au sol, pour lavabo H. 1070 mm. RIFP05. Bec au sol, pour baignoire H. 770 mm. RIFP06.  
/ Bodenstand-Wasserhahn für Waschbecken H. 1070 mm. RIFP05, für Badewanne H. 770 mm. RIFP06.  
/ Boca, de suelo para lavabo H. 1070 mm. RIFP05, para bañera H. 770 mm. RIFP06.

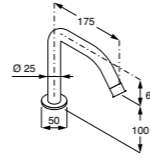

### Pipe

/ Bocca da piano h 100 per bidet. Aeratore a snodo richiudibile. RIFP07.  
/ Top-mounted spout H. 100 mm, for bidet RIFP07. Lockable swivel aerator.  
/ Bec monté sur plan H. 100 mm, pour bidet RIFP07. Aérateur avec articulation refermable.  
/ Waschtisch-Wasserhahn für Bidet, H. 100 mm. RIFP07. Verschließbare schwenkbare Wasserauslaufdüse.  
/ Boca bidet, H. 100 mm. RIFP07. Aireador a rótula que se puede cerrar.

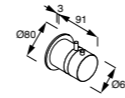

### Pipe

/ Miscelatore termostatico, inox satinato, parte esterna REFPO7E, parte incasso RHRX03I.  
/ Thermostatic mixer tap, satin stainless steel, external part REFPO7E, recessed part RHRX03I.  
/ Mitigeur thermostatique, inox satiné, partie externe REFPO7E, à encastrer RHRX03I.  
/ Thermostatmischer, Edelstahl satiniert, Außenteil RHRX03E. Einbauteil RHRX03I.  
/ Mezclador termostático, inox satinado, parte externa REFPO7E, parte empotrado RHRX03I.

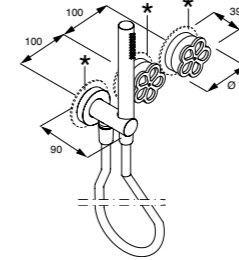

### Pipe

/ Gruppo doccia/vasca, incasso a parete. Miscelatore, deviatore 2 vie, doccetta. Uso vasca: erogazione al troppopieno, inox satinato+rosso, parte esterna RGFP03E, parte incasso RGGN03I.  
/ Built-in wall-mounted shower/bathtub tap set. Mixer, 2-way diverter, hand shower. Bathtub use: water supply to overflow, satin stainless steel+red, external part RGFP03E, recessed part RGGN03I.  
/ Batterie douche/baignoire, encastrement mural. Mitigeur, inverseur 2 voies, douchette. Utilisation baignoire : débit au trop-plein, inox satiné+rouge, partie externe RGFP03E / à encastrer RGGN03I.  
/ Wand-Armaturen für Badewanne und Dusche. Mischer, 2-Wege-Wasserlaufregler, Brausekopf. Für Badewanne: Wassereinfluss am Überlauf, Edelstahl satiniert+rot, Außenteil RGFP03E / Einbauteil RGGN03I.  
/ Grupo ducha/bañera, empotrado a la pared. Mezclador, desviador 2 vías, teleducha. Uso bañera: erogación al rebo sadero, inox satinado+rojo, parte externa RGFP03E / parte empotrado RGGN03I.

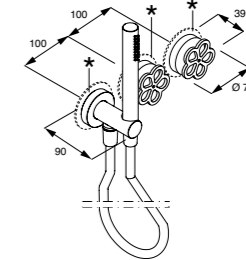

### Pipe

/ Gruppo doccia, incasso a parete. Miscelatore, deviatore 3 vie, doccetta. Inox satinato+rosso, parte esterna RGFP04E, parte incasso RGGN04I.  
/ Built-in wall-mounted shower tap set. Mixer, 3-way diverter, hand shower. Satin stainless steel+red, external part RGFP04E, recessed part RGGN04I.  
/ Batterie douche, encastrement mural. Mitigeur, inverseur 3 voies, douchette. Inox satiné+rouge, partie externe RGFP04E, à encastrer RGGN04I.  
/ Wand-Armaturen für Dusche. Mischer, 3-Wege Wasserlaufregler, Brausekopf. Edelstahl satiniert+rot, Außenteil RGFP04E. Einbauteil RGGN04I.  
/ Grupo ducha4, empotrado a la pared. Mezclador, desviador 3 vías, teleducha. Inox satinado+rojo, parte externa RGFP04E, parte empotrado RGGN04I.



### Pipe

/ Miscelatore lavabo, da piano. Inox satinato + rosso, REFPO3.  
/ Top-mounted mixer for washbasin. Satin stainless steel + red, REFPO3.  
/ Mitigeur pour plan lavabo. Inox satiné + rouge, REFPO3.  
/ Waschtisch-Mischer für Waschbecken. Edelstahl satiniert + rot, REFPO3.  
/ Mezclador lavabo de encimera, inox satinado + rojo, REFPO3.

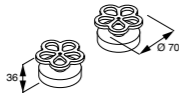

### Pipe

/ Coppia rubinetti lavabo, da piano. Inox satinato + rosso, RGFP01.  
/ Wall-mounted tap pair. Satin stainless steel + red, RGFP01.  
/ Paire robinets avec installation murale. Inox satiné + rouge, RGFP01.  
/ 2er-Wandarmaturen. Edelstahl satiniert + rot, RGFP01.  
/ Par grifos de pared, inox satinado + rojo, RGFP01.



### Pipe

/ Miscelatore lavabo/bidet/doccia, incasso a parete. Inox satinato + rosso, parte esterna REFPO4E/ parte incasso REGN04I.  
/ Wall-mounted, built-in washbasin/bidet/shower mixer tap. Satin stainless steel + red, external part REFPO4E / recessed part REGN04I.  
/ Mitigeur lavabo / bidet / douche, à encastrement mural. Inox satiné + rouge, partie externe REFPO4E / à encastrer REGN04I.  
/ Wandmischer für Waschbecken / Bidet und Dusche. Edelstahl satiniert + rot, Außenteil REFPO4E / Einbauteil REGN04I.  
/ Mezclador lavabo / bidet / ducha, empotrado a la pared, inox satinado + rojo, parte externa REFPO4E/ parte empotrado REGN04I.

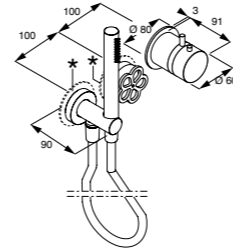

### Pipe

/ Gruppo termostatico doccia, incasso a parete. Miscelatore termostatico, deviatore 2 vie, doccetta, inox satinato+rosso, parte esterna RHFP02E, parte incasso RHGN02I. Deviatore 3 vie, inox satinato+rosso, parte esterna RHFP03E, parte incasso RHGN03I.  
/ Built-in wall-mounted shower thermostatic tap set. Thermostatic mixer, 2-way diverter, hand shower, satin stainless steel+red, external part RHFP02E, recessed part RHGN02I. 3-way diverter, satin stainless steel+red, external part RHFP03E, recessed part RHGN03I.  
/ Groupe thermostatique douche, encastrement mural. Mitigeur thermostatique, inverseur 2 voies, douchette, inox satiné+rouge, partie externe RHFP02E / à encastrer RHGN02I. Inverseur 3 voies, inox satiné+rouge, partie externe RHFP03E / à encastrer RHGN03I.  
/ Wand-Thermostatarmatur. Thermostatmischer, 2-Wege-Wasserlaufregler, Brausekopf, Edelstahl satiniert+rot, Außenteil RHFP02E / Einbauteil RHGN02I. 3-Wege-Wasserlaufregler, Edelstahl satiniert+rot, Außenteil RHFP03E / Einbauteil RHGN03I.  
/ Grupo termostático ducha, empotrado a la pared. Mezclador termostático, desviador 2 vías, teleducha, Inox satinado+rojo, parte externa RHFP02E / parte empotrado RHGN02I. Desviador 3 vías, inox satinado+rojo, parte externa RHFP03E / parte empotrado RHGN03I.

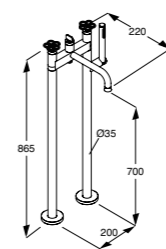

### Pipe

/ Gruppo vasca, a pavimento. Inox satinato+rosso, RGFP05.  
/ Freestanding floor-mounted bathtub tap set. Stainless steel+red, RGFP05.  
/ Batterie baignoire, au sol. Inox satiné+rouge, RGFP05.  
/ Bodenstand-Armaturengruppe für Badewanne. Edelstahl satiniert+rot, RGFP05.  
/ Grupo bañera, de suelo. Inox satinado+rojo, RGFP05.

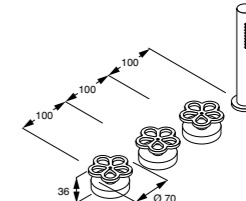

### Pipe

/ Gruppo bordo vasca, incasso. Senza bocca. Rubinetti caldo/freddo, doccetta con miscelatore dedicato, inox satinato+rosso, RGFP07. Rubinetti caldo/freddo, bocca, doccetta con miscelatore dedicato, inox satinato+rosso, RGFP06.  
/ Built-in deck-mounted tap set for bathtub. Without spout. Cold/warm taps, hand-shower with its mixer, stainless steel+red, RGFP07. Cold/warm taps, spout, hand-shower with its mixer, stainless steel+red, RGFP06.  
/ Batterie sur plage baignoire, encastrement. Sans bec. Robinets chaud/froid, douchette avec mitigeur dédié, inox satiné+rouge, RGFP07. Robinets chaud/froid, bec, douchette avec mitigeur dédié, inox satiné+rouge, RGFP06.  
/ Wannenrand-Armaturen. Ohne Wasserhahn. Armaturen warm/kalt, Brause mit entsprechendem Mischer, Edelstahl satiniert+rot, RGFP07. Armaturen warm/kalt, Wasserhahn, Brause mit entsprechendem Mischer, Edelstahl satiniert+rot, RGFP06.  
/ Grupo borde bañera, empotrado. Sin boca. Grifos caliente/frío, teleducha con mezclador específico, inox satinado+rojo, RGFP07. Grifos caliente/frío, boca, teleducha con mezclador específico, inox satinado+rojo, RGFP06.

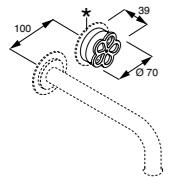

### Pipe

/ Miscelatore lavabo, incasso a parete. Inox satinato + rosso, parte esterna REFPO6E/ parte incasso REGN02I.  
/ Wall-mounted, built-in washbasin mixer tap. Satin stainless steel + red, external part REFPO6E/ recessed part REGN02I.  
/ Mitigeur lavabo, à encastrement mural. Inox satiné + rouge, partie externe REFPO6E / à encastrer REGN02I.  
/ Wandmischer für Waschbecken. Edelstahl satiniert + rot, Außenteil REFPO6E/ Einbauteil REGN02I.  
/ Mezclador lavabo, empotrado a la pared, inox satinado + rojo, parte externa REFPO6E/ parte empotrado REGN02I.

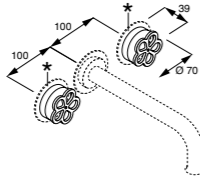

### Pipe

/ Coppia rubinetti lavabo, incasso a parete. Inox satinato + rosso, parte esterna RGFP02E/ parte incasso RGGN02I.  
/ Wall-mounted tap pair. Satin stainless steel + red, external part RGFP02E/ recessed part RGGN02I.  
/ Paire robinets avec installation murale. Inox satiné + rouge, partie externe RGFP02E / à encastrer RGGN02I.  
/ 2er-Wandarmaturen. Edelstahl satiniert + rot, Außenteil RGFP02E/ Einbauteil RGGN02I.  
/ Par grifos de pared, inox satinado + rojo, parte externa RGFP02E/ parte empotrado RGGN02I.

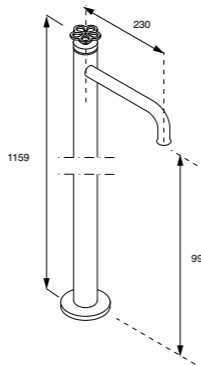

### Pipe

/ Miscelatore da terra per lavabo, inox satinato + rosso REFPO5.  
/ Floor-mounted mixer for washbasin, satin stainless steel + red REFPO5.  
/ Mitigeur haute pour lavabo, inox satiné + rouge REFPO5.  
/ Bodenstand-Mischer für Waschbecken, Edelstahl satiniert + rot REFPO5.  
/ Mezclador lavabo, de suelo, inox satinado + rojo REFPO5.

## Rubinetti Taps

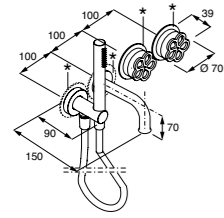

### Pipe

/ Gruppo vasca, incasso a parete. Miscelatore, bocca, deviatore e doccetta, inox satinato+rosso, parte esterna RGFPO8, parte incasso RGGN071.  
/ Built-in wall-mounted bathtub tap set. Mixer, spout, diverter and hand shower, stainless steel+red, external part RGFPO8, recessed part RGGN071.  
/ Batterie baignoire, encastrement mural. Mitigeur, bec, inverseur et douchette, inox satiné+rouge, partie externe RGFPO8 / à encastrer RGGN071.  
/ Wandarmaturen für Badewanne. Mischer, Wasserhahn, Wasserlaufregler und Brausekopf, Edelstahl satiniert+rot, Außenteil RGFPO8 / Einbauteil RGGN071.  
/ Grupo bañera, empotrado a la pared. Mezclador, boca, desviador y teleducha, inox satinado+rojo, parte externa RGFPO8 / parte empotrado RGGN071.

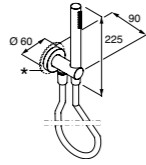

### Pipe

/ Doccetta a parete, con flessibile L. 1500 mm. e presa acqua, inox satinato RJFP01.  
/ Wall-mounted hand-shower, with flexible hose L. 1500 mm, water connection, satin stainless steel, RJFP01.  
/ Douchette murale, avec flexible L. 1500 mm. et eau branchement, inox satiné, RJFP01.  
/ Wandbefestigte Handdusche, mit flexibler, Wasseranschluß-schlauch L. 1500 mm, Wandanschluß, Edelstahl satiniert, RJFP01.  
/ Teleducha, de pared con flexo L. 1500 mm, racor, inox satinado, RJFP01.

### Uni

/ Rubinetteria in acciaio inox AISI 304, finitura satinata. / Taps in satin stainless steel AISI 304. / Robinetterie en acier inox satiné AISI 304. / Armaturen aus Edelstahl AISI 304 satiniert. / Griferia de acero inoxidable satinado AISI 304.

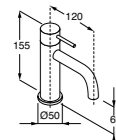

### Uni

/ Miscelatore monocomando per lavabo, senza comando di scarico REFU01.  
/ Mixer for washbasin, without pop-up REFU01.  
/ Mitigeur à une seule commande pour lavabo, sans commande de vidange. REFU01.  
/ Einhebelmischer für Waschbecken, ohne Ablaufregler REFU01.  
/ Mezclador lavabo, sin desagüe REFU01.

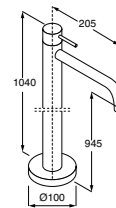

### Uni

/ Miscelatore monocomando da terra per lavabo, senza comando di scarico REFU04.  
/ Floor-mounted mixer for washbasin, without pop-up REFU04.  
/ Mitigeur à une seule commande pour lavabo, sans commande de vidange REFU04.  
/ Bodenstand-Mischer für Waschbecken, ohne Ablaufregler REFU04.  
/ Mezclador lavabo, de columna sin desagüe REFU04.

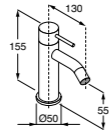

### Uni

/ Miscelatore monocomando per bidet, senza comando di scarico REFU02.  
/ Mixer for bidet, without pop-up REFU02.  
/ Mitigeur à une seule commande pour bidet, sans commande de vidange REFU02.  
/ Einhebelmischer für Bidet, ohne Ablaufregler REFU02.  
/ Mezclador bidet, sin desagüe REFU02.

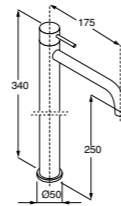

### Uni

/ Miscelatore monocomando, H. 340, mm. per lavabo, senza comando di scarico REFU03.  
/ 340 mm. high mixer for washbasin, without pop-up REFU03.  
/ Mitigeur à une seule commande H. 340 mm, pour lavabo, sans commande de vidange REFU03.  
/ Einhebelmischer für Waschbecken, H. 340 mm, ohne Ablaufregler REFU03.  
/ Mezclador lavabo, H. 340 mm, sin desagüe REFU03.

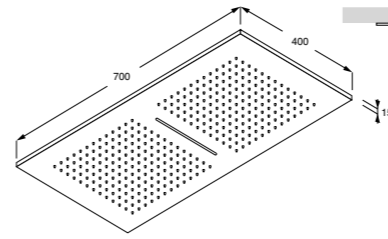

### Uni

/ Soffione doccia, a soffitto. Inox satinato, getto a pioggia, RFGZ03. Inox satinato, getto a pioggia + aeratore massaggio, RFGZ02. Inox satinato, getto a pioggia + cascata, RFGZ01.  
/ Ceiling-fixed shower head. Satin stainless steel, rain option, RFGZ03. Satin stainless steel, rain + aerator for massage options RFGZ02. Satin stainless steel, rain + waterfall options RFGZ01.  
/ Pomme douche, au plafond. Inox satiné, jet en pluie, RFGZ03. Inox satiné, jet en pluie + aérateur massage RFGZ02. Inox satiné, jet en pluie + cascade RFGZ01.  
/ Decken-Brausekopf. Edelstahl satiniert, Wasserregen, RFGZ03. Edelstahl satiniert, Wasserregen + Massage-Perlator RFGZ02. Edelstahl satiniert, Wasserregen + Wasser-schwall RFGZ01.  
/ Cabezal de ducha, de techo. Inox satinado, chorro lluvia, RFGZ03. Inox satinado, chorro lluvia + aeratore massaggio RFGZ02. Inox satinado, chorro lluvia + cascata RFGZ01.

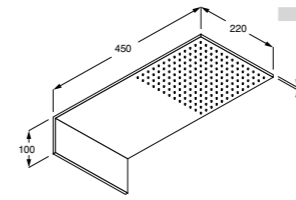

### Uni

/ Soffione doccia, a parete. Inox satinato, parte incasso, RRGZ01. Inox satinato, getto a pioggia, parte esterna, RFGZ04.  
/ Wall-mounted shower head. Satin stainless steel, recessed part, RRGZ01. Satin stainless steel, rain option, external part, RFGZ04.  
/ Pomme douche, murale. Inox satiné, partie à encastrement RRGZ01. Inox satiné, jet en pluie, partie externe, RFGZ04.  
/ Duschbrausekopf. Edelstahl satiniert, Unterputzelement RRGZ01. Edelstahl satiniert, Wasserregen, Aufputzelement, RFGZ04.  
/ Cabezal de ducha, de pared. Inox satinado, parte empotrado RRGZ01. Inox satinado, chorro lluvia, parte exterior RFGZ04.

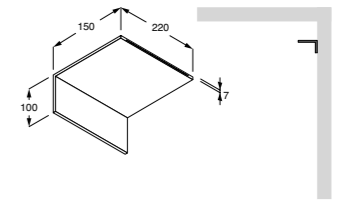

### Uni

/ Soffione doccia, a parete. Inox satinato, parte incasso, RRGZ01. Inox satinato, getto a cascata, parte esterna, RFGZ05.  
/ Wall-mounted shower head. Satin stainless steel, recessed part, RRGZ01. Satin stainless steel, waterfall option, external part, RFGZ05.  
/ Pomme douche, murale. Inox satiné, partie à encastrement RRGZ01. Inox satiné, jet à cascade, partie externe, RFGZ05.  
/ Duschbrausekopf. Edelstahl satiniert, Unterputzelement RRGZ01. Edelstahl satiniert, Wasserschwall, Aufputzelement, RFGZ05.  
/ Cabezal de ducha, de pared. Inox satinado, parte empotrado RRGZ01. Inox satinado, chorro en cascada, parte exterior RFGZ05.

### W1

/ Rubinetteria in acciaio inox AISI 304, finitura satinata. / Taps in satin stainless steel AISI 304. / Robinetterie en acier inox satiné AISI 304. / Armaturen aus Edelstahl AISI 304 satiniert. / Griferia de acero inoxidable satinado AISI 304.

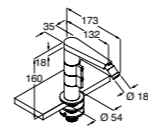

### \* W1

/ Miscelatore per bidet H. 160 mm. senza comando di scarico. REFA03.  
/ Mixer for bidet H. 160 mm, without pop-up. REFA03.  
/ Mitigeur pour bidet H. 160 mm, sans commande d'évacuation. REFA03.  
/ Mischer für Bidet H. 160 mm, ohne Ablaufregler. REFA03.  
/ Mezclador bidet, H. 160 mm, sin desagüe REFA03.

/

\* Disponibile fino ad esaurimento scorte  
Available until stock lasts

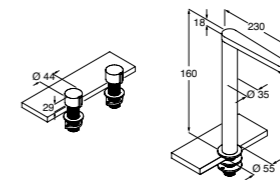

### \* W1

/ Gruppo due rubinetti da piano uso lavabo, vitoni ceramici da 1/2" apertura 90° (abbinamento con RIFA02/03/05). RGFA02. Bocca da piano alta per lavabo H. 160 mm. RIFA02. Per bidet RIFA05.  
/ Top-mounted group tap for washbasin, with 1/2" ceramic screw-disks and 90° opening (to be matched with codes RIFA02/03/05). RGFA02. Spout, for counter top mounting, for washbasin H. 160 mm. RIFA02. For bidet RIFA05.  
/ Batterie deux robinets du plan pour lavabo, vis en céramique 1/2" ouverture 90° (à utiliser avec becs code RIFA02/03/05). RGFA02. Grand bec du plan H. 160 mm. RIFA02. Pour bidet RIFA05.  
/ Zwei Drehgriffventile für Waschtisch für Waschbecken, mit Drehscheiben aus Keramik 1/2", Öffnung 90° (kombinierbar mit Code RIFA02/03/05). RGFA02. Waschtisch-Wasserhahn für Waschbecken H. 160 mm. RIFA02. Für Bidet RIFA05.  
/ Par grifos lavabo, de encimera para lavabo, con monturas cerámicas de 1/2", apertura 90°. (compatible con RIFA02/03/05). RGFA02. Boca, de encimera para lavabo H. 160 mm. RIFA02. Para bidet RIFA05.

/

\* Disponibile fino ad esaurimento scorte  
Available until stock lasts

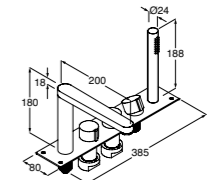

### \* W1

/ Gruppo bordo vasca composto da vitoni 3/4" caldo/freddo grande portata, bocca erogazione, doccetta manuale comandata da miscelatore. RGFA06.  
/ Deck-mounted group composed with 3/4" screw disks, cold/hot water, great water supply, spout and hand-shower controlled by the mixer. RGFA06.  
/ Batterie pour plage baignoire composée par vis 3/4" eaux chaude/froide, haut débit, bec, douchette à main commandé par un mitigeur. RGFA06.  
/ Wannenrand-Armaturengruppe, ausgestattet mit Drehhebeln 3/4", Kalt/Warmwasser, große Wassermenge Handdusche und Mischer. RGFA06.  
/ Grupo borde bañera, empotrado, con grifos frío/caliente con monturas 3/4". Boca. Teleducha con mezclador específico. RGFA06.

/

\* Disponibile fino ad esaurimento scorte  
Available until stock lasts

## Rubinetti Taps

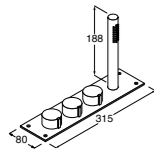

### \* W1

/ Gruppo bordo vasca erogazione al troppopieno composto da vitoni 3/4" caldo/freddo grande portata, doccetta manuale comandata da miscelatore. RGFA05.  
/ Deck-mounted group, water supply to overflow, composed with 3/4" screw disks, cold/hot water, great water supply and hand-shower controlled by the mixer. RGFA05.  
/ Batterie pour plage baignoire, débit au tropplein, composée par vis 3/4" eaux chaude/froide, haut débit, douchette à main commandé par un mitigeur. RGFA05.  
/ Wannensrand-Armaturengruppe, Versorgung am Überlauf, ausgestattet mit Drehscheiben 3/4", Kalt/Warmwasser, große Wassermenge und Handdusche. RGFA05.  
/ Grupo borde bañera, empotrado, sin boca, con grifos frío/caliente con monturas 3/4". Teleducha con mezclador específico. RGFA05.

/

\* Disponibile fino ad esaurimento scorte  
Available until stock lasts

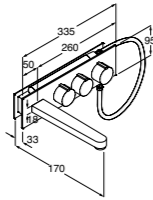

### \* W1

/ Gruppo vasca incasso parete composto da vitoni 3/4" caldo/freddo grande portata, bocca erogazione, doccetta manuale comandata da miscelatore. Parte incasso RGFA071, parte esterna RGFA07E.  
/ Built-in group composed by 3/4" screw disks, cold/hot water, great water supply, spout and hand-shower controlled by the mixer. Recessed part RGFA071, external RGFA07E.  
/ Batterie baignoire à installation murale composée par vis 3/4" eaux chaude/froide, haut débit, douchette à main commandé par un mitigeur. Partie à encastrer, RGFA071, partie externe RGFA07E.  
/ Wand-Armaturen für Badewannen, ausgestattet mit Kalt-/Warmwasser-Armaturen mit Drehscheiben 3/4", große Wassermenge, Handbrause mit entsprechendem Mischer und Mischer. Einbauteil RGFA071, Außenteil RGFA07E.  
/ Grupo bañera, empotrado a la pared, con grifos frío/caliente con monturas 3/4". Boca y teleducha con mezclador específico. Parte empotrado RGFA071, externa RGFA07E.

/

\* Disponibile fino ad esaurimento scorte  
Available until stock lasts

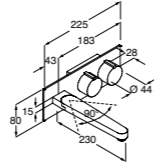

### \* W1

/ Gruppo incasso parete per lavabo, vitoni ceramici 1/2" apertura 90°, bocca girevole. Parte incasso RGFA09I, parte esterna RGFA09E.  
/ Built-in group for washbasin, with 1/2" ceramic screw-disks, 90° opening and revolving spout. Recessed part RGFA09I, external RGFA09E.  
/ Batterie robinetterie murale pour lavabo, vis en céramique 1/2" ouverture 90°, bec tournant. Partie à encastrer, RGFA09I, partie externe RGFA09E.  
/ Wand-Armaturen für Waschbecken, mit Keramik-Drehscheiben 1/2", 90° Öffnung und Drehwasserhahn. Einbauteil RGFA09I, Außenteil RGFA09E.  
/ Grupo lavabo, empotrado a la pared. Monturas cerámicas de 1/2", apertura 90°, boca giratoria. Parte empotrado RGFA09I, externa RGFA09E.

/

\* Disponibile fino ad esaurimento scorte  
Available until stock lasts

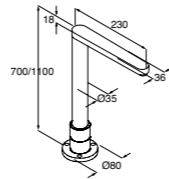

### \* W1

/ Bocca da pavimento per lavabo H. 1100 mm. RIFA03. Bocca da terra per vasca H. 700 mm. RIFA04.  
/ Fixed-floor spout for washbasin H. 1100 mm. RIFA03. Fixed-floor spout for bathtub H. 700 mm. RIFA04.  
/ Bec du sol pour lavabo H. 1100 mm. RIFA03. Bec du sol pour baignoire H. 700 mm. RIFA04.  
/ Bodenstand-Wasserhahn für Waschbecken H. 1100 mm. RIFA03. Bodenbefestigter Wasserhahn für Badewanne H. 700 mm. RIFA04.  
/ Boca, de suelo. Para lavabo H. 1100 mm. RIFA03. Para bañera H. 700 mm. RIFA04.

/

\* Disponibile fino ad esaurimento scorte  
Available until stock lasts

## Wings

/ Rubinetteria in acciaio inox AISI 304, finitura satinata o \*lucida. / Taps in stainless steel AISI 304, satinised or \*polished finish. / Robinetterie en acier AISI 304 finition satinée ou \*poli. / Armaturen aus Edelstahl AISI 304, satiniert oder \*glänzend. / Griferia de acero inoxidable AISI 304, satinado o\*brillante.

/

\*Lucida / \*Polished / \*Poli / \*Glänzend / \*Brillante  
Disponibile fino ad esaurimento scorte  
Available until stock lasts

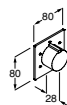

### \* W1

/ Deviatore da incasso a 5 vie, attacco uscite 1/2". Parte incasso RVFA01I, parte esterna RVFA01E.  
/ 5-ways built-in diverter, 1/2" connection. Recessed part RVFA01I, external RVFA01E.  
/ Déviateur à encastrer à 5 voies, branchement 1/2". Partie à encastrer, RVFA01I, partie externe RVFA01E.  
/ 5-Weg-Einbau-Wasserlaufregler, Anschluß 1/2". Einbauteil RVFA01I, Außenteil RVFA01E.  
/ Desviador de 5 vías, empotrado a la pared. Racores 1/2". Parte empotrado RVFA01I, externa RVFA01E.

/

\* Disponibile fino ad esaurimento scorte  
Available until stock lasts

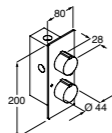

### \* W1

/ Gruppo incasso termostatico a parete con deviatore utilizzabile fino a 2 vie e regolazione dell'erogazione acqua. Parte incasso RHFA01I, parte esterna RHFA01E.  
/ Wall mounting built in thermostatic group with 2-way diverter and adjustable water supply. Recessed part RHFA01I, external RHFA01E.  
/ Batterie thermostatique à encastrement mural avec déviateur utilisable jusqu'à 2 voies et régulation débit eau. Partie à encastrer, RHFA01I, partie externe RHFA01E.  
/ Wandthermostatmischer mit 2-Weg-Wasserlaufregler und Wasserversorgungsregelung. Einbauteil RHFA01I, Außenteil RHFA01E.  
/ Grupo empotrado termoestático, de pared, con desviador, de 2 vías. Parte empotrado RHFA01I, externa RHFA01E.

/

\* Disponibile fino ad esaurimento scorte  
Available until stock lasts

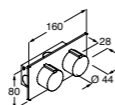

### \* W1

/ Gruppo due rubinetti incasso parete, vitoni ceramici 3/4", apertura 90°, uso lavabo (abbinamento canne RIFA01/02/03/05), uso doccia (abbinabile con cod. RFDM01/02/03) uso vasca (abbinamento bocca RIFA04). Parte incasso RGFA03I, parte esterna RGFA03E.  
/ Built-in group tap with 3/4" ceramic screw disks and 90° opening, for washbasin (to be matched with codes RIFA 01/02/03/05), for shower (to be matched with RFDM01/02/03), for bathtub (to be matched with spout RIFA04). Recessed part RGFA03I, external RGFA03E.  
/ Batterie deux robinets à encastrement mural, vis en céramique 3/4", ouverture 90°, pour lavabo (à utiliser avec becs code RIFA 01/02/03/05), pour douche (à utiliser avec RFDM01/02/03) pour baignoire (à utiliser avec bec RIFA04). Partie à encastrer, RGFA03I, partie externe RGFA03E.  
/ Zwei Wand-Drehgriffventile, mit Keramik-Drehscheiben 3/4", 90° Öffnung, für Waschbecken (kombinierbar mit Code RIFA01/02/03/05), für Dusche (kombinierbar mit Code RFDM 01/02/03, Minimal) und für Badewanne (kombinierbar mit Code RIFA04). Einbauteil RGFA03I, Außenteil RGFA03E.  
/ Grupo empotrado a la pared. Monturas cerámicas de 3/4", apertura 90°. Uso lavabo: compatibles con RIFA01/02/03/05. Uso bañera: compatibles con RIFA04. Uso ducha: compatibles con RFDM01/02/03 (serie MINIMAL). Parte empotrado RGFA 03I, externa RGFA03E.

/

\* Disponibile fino ad esaurimento scorte  
Available until stock lasts

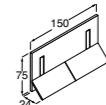
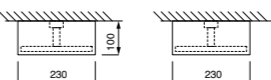
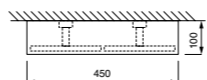
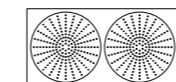

## Wings

/ Gruppo incasso per lavabo, bidet e doccia, composto da leve caldo e fredda. (Completare con cassetta da incasso a muro cod. RRNS03 ed eventuale bocca cod. RINS09/10/11/12/13/14/15/16/17/18/ da ordinare separatamente). Finitura satinata RHNS03, finitura lucida RHNS04.  
/ Built-in group for washbasin, shower and bidet, with hot and cold lever. (To be matched with recessed wall container cod. RRNS03 and eventual spout cod. RINS09/10/11/12/13/14/15/16/17/18 / to be ordered separately) satin finish RHNS03, polished finish RHNS04.  
/ Batterie à encastrer pour lavabo, bidet et douche, composé de leviers chaud et froid. (Compléter avec boîtier à encastrer au mur code RRNS03 et éventuel bec code RINS09/10/11/12/13/14/15/16/17/18 / a commander séparément). Finition satiné RHNS03, finition poli RHNS04.  
/ Wand-Armaturengruppe für Waschbecken/Bidet/Dusche, mit Hebel für kalt- und warmes Wasser. (Zu ergänzen mit Wand-Einbaukasten Code RRNS03 und eventuellem Wasserhahn Code RINS09/10/11/12/13/14/15/16/17/18 / Separat zu bestellen), satiniert RHNS03, glänzend RHNS 04.  
/ Grupo lavabo/bidet/ducha, empotrado a la pared. Compatible con RINS09/10/11/12/13/14/15/16/17/18. Completar con caja empotrada a la pared. Satinado RHNS03, brillante RHNS04.

## Rubinetti Taps

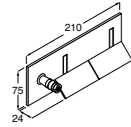

### Wings

/ Gruppo incasso per vasca, composto da leve caldo e freddo. (Completare con cassetta da incasso a muro cod. RRNS01 e bocca cod. RINS19/20/21/22/ da ordinare separatamente). Finitura satinata RHNS07. Finitura lucida RHNS08.

/ Built-in group for bathtub, with hot and cold lever. (To be matched with recessed wall container cod. RRNS01 and spout cod. RINS19/20/21/22 / to be ordered separately). Satin finish RHNS07. Polished finish RHNS08.

/ Batterie à encastrer pour baignoire, composé de leviers chaud et froid. (Compléter avec boîtier à encastrer au mur code RRNS01 et bec code RINS19/20/21/22 / a commander séparément). Finition satiné RHNS07. Finition poli RHNS08.

/ Wand-Armaturengruppe für Badewanne mit Hebel für kalt- und warmes Wasser. (Zu ergänzen mit Wand-Einbaukasten Code RRNS01 und Wasserhahn Code RINS19/20/21/22/ Separat zu bestellen). Satiniert RHNS07. Glänzend RHNS08. / Grupo bañera, empotrado a la pared. Compatible con RINS19/20/21/22. Boca a pedir por separado. Completar con caja empotrada a la pared. Satinado RHNS07, brillante RHNS08.

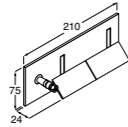

### Wings

/ Gruppo incasso per lavabo e bidet, composto da leve caldo e freddo. (Completare con cassetta da incasso a muro cod. RRNS01 o cassetta da incasso specifica per boiserie Pianura cod. RRNS04 e bocca cod. RINS01/02/03/04 05/06 07/08/ da ordinare separatamente). Finitura satinata RHNS01. Finitura lucida RHNS02.

/ Built-in group for washbasin and bidet, with hot and cold lever, without spout. (To be matched with recessed wall container cod. RRNS01 or recessed wall container specifically for boiserie Pianura cod. RRNS04 and spout cod. RINS01/02/03/04/05/06/07/08 / to be ordered separately). Satin finish RHNS01. Polished finish RHNS02.

/ Batterie pour lavabo et bidet, composée de leviers chaud et froid. (Compléter avec boîtier à encastrer au mur code RRNS01 ou boîtier à encastrer spécifique pour boiserie Pianura code RRNS04 et bec code RINS01/02/03/04/05/06/07/08 / a commander séparément). Finition satiné RHNS01. Finition poli RHNS02.

/ Wand-Armaturengruppe für Waschbecken und Bidet, mit Hebel für kalt- und warmes Wasser. (Zu ergänzen mit Wand-Einbaukasten Code RRNS01 oder Wand-Einbaukasten für Boiserie Pianura Code RRNS04 und Wasserhahn Code RINS01/02/03/04/05/06/07/08 / Separat zu bestellen), satiniert RHNS01, glänzend RHNS02. / Grupo lavabo/bidet, empotrado a la pared. Compatible con RINS01/02/03/04/05/06/07/08. Boca a pedir por separado. Completar con caja empotrada a la pared. A usar en copete Pianura, completar con placa RRNS04. Satinado RHNS01, brillante RHNS02.

/ Grupo lavabo/bidet, empotrado a la pared. Compatible con RINS01/02/03/04/05/06/07/08. Boca a pedir por separado. Completar con caja empotrada a la pared. A usar en copete Pianura, completar con placa RRNS04. Satinado RHNS01, brillante RHNS02.

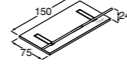

### Wings

/ Gruppo per lavabo da piano, composto da leve caldo e freddo, scatola di drenaggio inclusa. (Completare con bocca cod. RINS09/10/11/12/15/16/23/24/25/26/ da ordinare separatamente). Finitura satinata RHNS05, finitura lucida RHNS06.

/ Top-mounted tap set for washbasin, with hot and cold lever, drainage box included. (To be matched with spout cod. RINS09/10/11/12/15/16/23/24/25/26/ to be ordered separately) satin finish RHNS05, polished finish RHNS06.

/ Batterie pour lavabo montée sur plan, composé de leviers chaud et froid, boîte de drainagem incluse. (Compléter avec bec code RINS09/10/11/12/15/16/23/24/25/26/ A commander séparément). Finition satiné RHNS05. Finition poli RHNS06.

/ Armaturengruppe für Waschtischbecken, mit Hebel für kalt- und warmes Wasser und Drängehäuse. (Zu ergänzen mit Wasserhahn Code RNS09/10/11/12/15/16/23/24/25/26/ Separat zu bestellen) Satiniert RHNS05. Glänzend RHNS06.

/ Grupo lavabo, de encimera, Caja de drenaje incluida (Compatible con RINS09/10/11/12/15/16/23/24/25/26, a pedir por separado). Satinado RHNS05, brillante RHNS06.

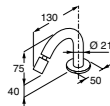

### Wings

/ Bocca da piano, per bidet. Finitura satinata RINS13. Finitura lucida RINS14.

/ Countertop-mounted spout for bidet, satin finish RINS13, polished finish RINS14.

/ Bec monté sur plan, pour bidet. Finition satiné RINS13. Finition poli RINS14.

/ Wasserhahn für Bidet. Satiniert RINS13. Glänzend RINS14. / Boca bidet, inox satinado RINS13, inox brillante RINS14.

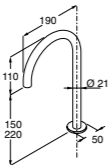

### Wings

/ Bocca da piano, per lavabo. H. 150 mm, finitura satinata RINS09, finitura lucida RINS10. H. 220 mm, finitura satinata RINS11, finitura lucida RINS12.

/ Countertop-mounted spout for washbasin. H. 150 mm, satin finish RINS09, polished finish RINS10. H. 220 mm, satin finish RINS11, polished finish RINS12.

/ Bec monté sur plan, pour lavabo. H. 150 mm, finition satiné RINS09, finition poli RINS10. H. 220 mm, finition satiné RINS11, finition poli RINS12.

/ Wasserhahn für Waschbecken H. 150 mm, satiniert RINS09, glänzend RINS10. H. 220 mm, satiniert RINS11, glänzend RINS12.

/ Boca lavabo. H. 150 mm, inox satinado RINS09, inox brillante RINS09. H. 220 mm, satinado RINS11, brillante RINS12.

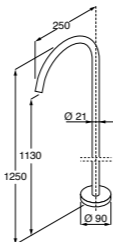

### Wings

/ Bocca da terra H. 1130 mm, per lavabo, finitura satinata RINS15, finitura lucida RINS16. Bocca da terra H. 700 mm, per vasca, finitura satinata RINS17, finitura lucida RINS18. / Floor-mounted spout, H. 1130 mm, for washbasin satin finish RINS15, polished finish RINS16. Floor-mounted spout H. 700 mm, for bathtub satin finish RINS17, polished finish RINS18.

/ Bec au sol H. 1130 mm, pour lavabo, finition satiné RINS15, finition poli RINS16. Bec au sol H. 700 mm, pour baignoire, finition satiné RINS17, finition poli RINS18.

/ Bodenstand-Wasserhahn für Waschbecken H. 1130 mm, satiniert RINS15, glänzend RINS16. Bodenstand-Wasserhahn für Badewanne H. 700 mm, satiniert RINS17, glänzend RINS18.

/ Boca lavabo, de suelo H. 1130 mm, inox satinado RINS15, inox brillante RINS16. Boca bañera, de suelo H. 700 mm, inox satinado RINS17, inox brillante RINS18.

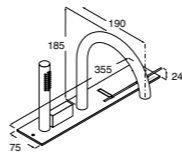

### Wings

/ Gruppo bordo vasca, composto da leve caldo e freddo, bocca di erogazione, doccino con miscelatore dedicato. Finitura satinata RGNS01. Finitura lucida RGNS02.

/ Deck-mounted cold and hot water lever, spout, hand-shower with its mixer. Satin finish RGNS01. Polished finish RGNS02.

/ Batterie sur plage baignoire, composée de leviers chaud et froid, bec de débit, douchette avec mitigeur dédié. Finition satiné RGNS01. Finition poli RGNS02.

/ Wannenrand-Armaturengruppe, mit Hahn, Handdusche mit spezifischem Mischer. Satiniert RGNS01. Glänzend RGNS02.

/ Grupo borde bañera, empotrado con teleducha con mezclador específico. Inox satinado RGNS01, inox brillante RGNS02.

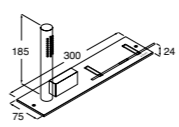

### Wings

/ Gruppo bordo vasca, con erogazione al troppopieno, composto da leve caldo e freddo, doccino con miscelatore dedicato. Finitura satinata RGNS03. Finitura lucida RGNS04.

/ Deck-mounted cold and hot water lever with water supply from overflow, spout, hand shower with its mixer. Satin finish RGNS03. Polished finish RGNS04.

/ Batterie sur plage baignoire, avec remplissage par trop-plein, bec de débit, douchette avec mitigeur dédié. Finition satiné RGNS03. Finition poli RGNS04.

/ Wannenrand-Armaturengruppe mit Wasserversorgung am Überlauf, Hebel für kalt- und warmes Wasser, Handdusche mit spezifischem Mischer. Satiniert RGNS03, glänzend RGNS04.

/ Grupo borde bañera, sin boca, empotrado con teleducha con mezclador específico. Inox satinado RGNS03, inox brillante RGNS04.

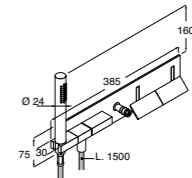

### Wings

/ Gruppo da incasso per vasca, composto da leve caldo e freddo, doccino con miscelatore dedicato. (Completare con cassetta da incasso a muro cod. RRNS02 e bocca cod. RINS19/20/21/22/ da ordinare separatamente). Finitura satinata RHNS15, Finitura lucida RHNS16.

/ Built-in group for bathtub, with levers for hot and cold water, hand-shower with its mixer. (To be matched with recessed wall container cod. RRNS02 and spout cod. RINS19/20/21/22/ to be ordered separately). Satin finish RHNS15, polished finish RHNS16.

/ Batterie à encastrer pour baignoire, composé de leviers chaud et froid, douchette avec mitigeur dédié. (Compléter avec boîtier à encastrer au mur code RRNS02 et bec code RINS19/20/21/22/ a commander séparément). Finition satiné RHNS15. Finition poli RHNS16.

/ Wand-Armaturen für Badewanne, mit Hebel für kalt- und warmes Wasser und Handdusche mit spezifischem Mischer. (Zu ergänzen mit Wand-Einbaukasten Code RRNS02 und Wasserhahn Code RINS19/20/21/22 / Separat zu bestellen) Satiniert RHNS15, glänzend RHNS16.

/ Grupo bañera, empotrado a la pared. Teleducha con mezclador específico. Compatible con RINS19/20/21/22. Boca a pedir por separado. Completar con caja empotrada a la pared. Inox satinado RHNS15, inox brillante RHNS16.

## Rubinetti Taps

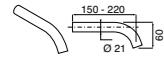

### Wings

/ Bocca erogazione per lavabo. L. 150 mm, finitura satinata RINS01, finitura lucida RINS02. L. 220 mm, finitura satinata RINS03, finitura lucida RINS04.

/ Spout for washbasin L. 150 mm, satin finish RINS01, polished finish RINS02. L. 220 mm, satin finish RINS03, polished finish RINS04.

/ Bec de débit pour lavabo L. 150 mm, finition satiné RINS01, finition poli RINS02. L. 220 mm. - finition satiné RINS03, finition poli RINS04.

/ Wand-Wasserhahn für Waschbecken. L. 150 mm, satiniert RINS01, glänzend RINS02. L. 220 mm, satiniert RINS03, glänzend RINS04.

/ Boca lavabo, de pared. L. 150 mm, inox satinado RINS01, inox brillante RINS02. L. 220 mm, inox satinado RINS03, inox brillante RINS04.

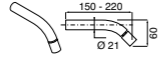

### Wings

/ Bocca erogazione per bidet. L. 150 mm, finitura satinata RINS05, finitura lucida RINS06. L. 220 mm, finitura satinata RINS07, finitura lucida RINS08.

/ Spout for bidet L. 150 mm, satin finish RINS05, polished finish RINS06. L. 220 mm, satin finish RINS07, polished finish RINS08.

/ Bec de débit pour bidet L. 150 mm, finition satiné RINS05, finition poli RINS06. L. 220 mm, finition satiné RINS07, finition poli RINS08.

/ Wand-Wasserhahn für Bidet. L. 150 mm, satiniert RINS05, glänzend RINS06. L. 220 mm, satiniert RINS07, glänzend RINS08.

/ Boca bidet, de pared. L. 150 mm, inox satinado RINS05, inox brillante RINS06. L. 220 mm, inox satinado RINS07, inox brillante RINS08.

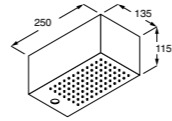

### Wings

/ Doccia a soffitto, composta da 1 soffione orientabile in finitura satinata e scatola di installazione esterna in bianco opaco. RFNS03.

/ Ceiling-fixed adjustable shower head, satin finish, with external installation part in mat white finish RFNS03.

/ Douche murale, composé de 1 pomme de douche orientable en finition satiné et boîte d'installation externe en finition blanc mat. RFNS03.

/ Decken-Brausekopf verstellbar, Ausführung satiniert und Außeninstallationsgehäuse, Ausführung weiß matt RFNS03.

/ Cabezal de ducha Orientable, de techo, inox satinado. Caja de instalación externa, blanco mate. RFNS03.

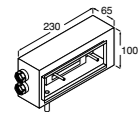

### Wings

/ Cassetta da incasso a muro, L. 230, H. 100 mm. Attacchi 1/2", per cod. RHNS01/02/07/08/09/10. RRNS01.

/ Recessed wall container, L. 230, H. 100 mm. 1/2" connection, for codes RHNS01/02/07/08/09/10. RRNS01.

/ Boîtier à encastrer au mur, L. 230, H. 100 mm. Attaches 1/2", pour code RHNS01/02/07/08/09/10. RRNS01.

/ Wand-Einbaukasten, L. 230, H. 100 mm. Anschlüsse 1/2" für Code RHNS01/02/07/08/09/10. RRNS01.

/ Caja de empotrar a la pared. L. 230, H. 100 mm. Racores 1/2". Para RHNS01/02/07/08/09/10. RRNS01.

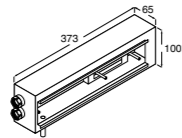

### Wings

/ Cassetta da incasso a muro, L. 373, H. 100 mm. Attacchi 1/2", per cod. RHNS11/12/13/14/15/16. RRNS02.

/ Recessed wall container, L. 373, H. 100 mm. 1/2" connection, for codes RHNS11/12/13/14/15/16. RRNS02.

/ Boîtier à encastrer au mur, L. 373, H. 100 mm. Attaches 1/2", pour code RHNS11/12/13/14/15/16. RRNS02.

/ Wand-Einbaukasten, L. 373, H. 100 mm. Anschlüsse 1/2" für Code RHNS11/12/13/14/15/16. RRNS02.

/ Caja de empotrar a la pared. L. 373, H. 100 mm. Racores 1/2". Para RHNS11/12/13/14/15/16. RRNS02.

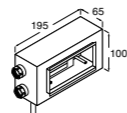

### Wings

/ Cassetta da incasso a muro, L. 195, H. 100 mm. Attacchi 1/2", per cod. RHNS03/04. RRNS03.

/ Recessed wall container, L. 195, H. 100 mm. 1/2" connection, for codes RHNS03/04. RRNS03.

/ Boîtier à encastrer au mur, L. 195, H. 100 mm. Attaches 1/2", pour code RHNS03/04. RRNS03.

/ Wand-Einbaukasten, L. 195, H. 100 mm. Anschlüsse 1/2" für Code RHNS03/04. RRNS03.

/ Caja de empotrar a la pared. L. 195, H. 100 mm. Racores 1/2". Para RHNS03/04. RRNS03.

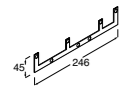

### Wings

/ Piastra per incasso rubinetteria, specifica per boiserie Pianura, L. 246, H. 45 mm. Completa di coppia flessibili per collegamento idrico. Per cod. RHNS01/02. RRNS04.

/ Plate for tap housing, specific for Pianura back-splash, L. 246, H. 45 mm. With hoses. For cod. RHNS01/02. RRNS04.

/ Plaque pour encastrément robinetterie, spécifique pour boiserie Pianura, L. 246, H. 45 mm. Munie de couple de flexibles pour raccordement hydrique. Pour cod. RHNS01/02. RRNS04.

/ Wandplatte zur Verwendung an Rückwand Pianura, B. 246, H. 45 mm. Ausgestattet mit Schlauchpaar für Wasseranschluss. Für Code RHNS01/02. RRNS04.

/ Placa a empotrar en copete Pianura. Con flexos. Para cod. RHNS01/02. RRNS04.

## Articoli Universali / Universal Items / Articles Universels / Universelle Artikel / Artículos Universales

/ Articoli abbinabili a tutte le collezioni Boffi. / Items matchable with all Boffi collections. / Articles associables à toutes les collections Boffi. / Artikel sind mit allen Kollektionen von Boffi kombinierbar. / Artículos combinables con todas las colecciones Boffi.

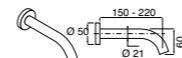

/ Bocca erogazione per lavabo - Installazione a parete o alzata Pianura. L. 150 mm, inox satinato RINS23, inox lucido RINS24, cromo RINS27, grigio PVD RINS29. L. 220 mm, inox satinato RINS25, inox lucido RINS26, cromo RINS28, grigio PVD RINS30.

/ Spout for washbasin-Wall-mounted or for Pianura backsplash. L. 150 mm, satin stainless steel RINS23, polished stainless steel RINS24, chrome RINS27, PVD grey RINS29. L. 220 mm, satin stainless steel RINS25, polished stainless steel RINS26, chrome RINS28, PVD grey RINS30.

/ Bec de débit pour lavabo - Installation murale ou dos Pianura. L. 150 mm, inox satiné RINS23, inox poli RINS24, chrome RINS27, gris PVD RINS29. L. 220 mm, inox satiné RINS25, inox poli RINS26, chrome RINS28, gris PVD RINS30.

/ Wasserhahn für Waschbecken - Wand montiert oder an Rückwand Pianura montiert. L. 150 mm, Edelstahl satiniert RINS23, Edelstahl glänzend RINS24, verchromt RINS27, grau PVD RINS29. L. 220 mm, Edelstahl satiniert RINS25, Edelstahl glänzend RINS26, verchromt RINS28, grau PVD RINS30.

/ Boca lavabo, de pared o copete Pianura. L. 150 mm, inox satinado RINS23, inox brillante RINS24, cromo RINS27, gris PVD RINS29. L. 220 mm, inox satinado RINS25, inox brillante RINS26, cromo RINS28, gris PVD RINS30.

/ Placca di comando per cassetta di scarico GEBERIT UP320, UP720. Comandi a filo, senza fissaggi a vista. Inox satinato RRCT11 / inox lucido RRCT12 / grigio PVD RRCT15. / WC flush plate for Geberit UP320, UP720. With flush-mounted controls. Without visible fastening elements. Satin stainless steel RRCT11 / polished stainless steel RRCT12 / PVD grey RRCT15.

/ Plaque de commande pour boîtier d'écoulement pour Geberit UP320, UP720. Commandes affleurantes. Sans fixations visibles. Inox satiné RRCT11 / inox poli RRCT12 / gris PVD RRCT15.

/ Betätigungsfeld für die Wasserspülung für GEBERIT UP320, UP720. Flächenbündige Tasten, ohne Befestigungselemente einsehbar. Edelstahl satiniert RRCT11 / Edelstahl glänzend RRCT12 / grau PVD RRCT15.

/ Placa de mando para cisternas de descarga para GEBERIT UP320, UP720. Mandos enrasados. Sin fijación visible. Inox satinado RRCT11 / inox brillante RRCT12 / gris PVD RRCT15.

/ Placca di comando per cassetta di scarico GEBERIT UP320, UP720. Senza fissaggi a vista. Inox satinato RRCT13 / inox lucido RRCT14 / grigio PVD RRCT16.

/ WC flush plate for Geberit UP320, UP720. Without visible fastening elements. Satin stainless steel RRCT13 / polished stainless steel RRCT14 / PVD grey RRCT16.

/ Plaque de commande pour boîtier d'écoulement pour Geberit UP320, UP720. Sans fixations visibles. Inox satiné RRCT13 / inox poli RRCT14 / gris PVD RRCT16.

/ Betätigungsfeld für die Wasserspülung für GEBERIT UP320, UP720. Ohne Befestigungselemente einsehbar. Edelstahl satiniert RRCT13 / Edelstahl glänzend RRCT14 / grau PVD RRCT16.

/ Placa de mando para cisternas de descarga para GEBERIT UP320, UP720. Sin fijación visible. Inox satinado RRCT13 / inox brillante RRCT14 / gris PVD RRCT16.

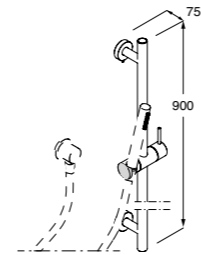

/ Asta saliscendi con supporto per doccia. Inox satinato RRZZ01, inox lucido RRZZ02, grigio PVD RRRX02.

/ Shower riser rail with shower head holder. Satin stainless steel RRZZ01/polished stainless steel RRZZ02/PVD grey RRRX02.

/ Barre de douche avec support pour douchette. Inox satiné RRZZ01 / inox poli RRZZ02 / gris PVD RRRX02.

/ Duschstange mit Halterung für Brausekopf. Edelstahl satiniert RRZZ01 / Edelstahl glänzend RRZZ02 / grau PVD RRRX02.

/ Barra deslizante con soporte para teleducha. Inox satinado RRZZ01 / inox brillante RRZZ02 / gris PVD RRRX02.

## Accessori Accessories

### Blade

/ Accessori da bagno, in acciaio inox AISI 304, spessore 4 mm, finitura lucida/ satinata/ grigio grafite PVD. / Bathroom accessories, in stainless steel AISI 304, th. 4 mm, polished / satin / grey PVD finish. / Accessoires de salle de bain, en acier inox AISI 304, ép. 4 mm, finition polie / satinée / gris graphite PVD. / Zubehör für Bäder aus Edelstahl AISI 304, Stärke 4 mm, Ausführung glänzend / satiniert / Grafitgrau PVD. / Accesorios baño de acero inoxidable AISI 304, de 4 mm. de espesor, acabado brillante / satinada / gris grafito PVD.

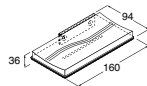

### Blade

/ Porta sapone da parete, con appoggio sapone in legno teak, L. 160, H. 36, P. 94 mm. Finitura lucida KIBSA01, finitura satinata KIBSA03, grigio PVD cod. KIBSA05.  
/ Wall-mounted soap-dish with teak wood dish, W. 160, H. 36, D. 94 mm. Polished finish KIBSA01, satin finish KIBSA03, PVD grey KIBSA05.  
/ Porte-savon mural avec appui en teak pour savon, L. 160, H. 36, P. 94 mm. Finition poli KIBSA01, finition mat KIBSA03, gris PVD cod. KIBSA05.  
/ Wandseifenschale mit Seifenhalter aus Teak Holz, B. 160, H. 36, T. 94 mm. Glänzend KIBSA01, satiniert KIBSA03, grau PVD cod. KIBSA05.  
/ Jabonera de pared, con balda de madera de teca. L. 160, H. 36, P. 94 mm. Acero inoxidable brillante KIBSA01, satinado KIBSA03, gris PVD cod. KIBSA05.

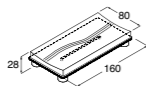

### Blade

/ Porta sapone da appoggio, con appoggio sapone in legno teak, L. 160, H. 28, P. 80 mm. Finitura lucida KIBSA02, finitura satinata KIBSA04, grigio PVD cod. KIBSA06.  
/ Top-mounted soap-dish with teak wood dish, W. 160, H. 28, D. 80 mm. Polished finish KIBSA02, satin finish KIBSA04, PVD grey KIBSA06.  
/ Porte-savon avec appui en teak pour savon, L. 160, H. 28, P. 80 mm. Finition poli KIBSA02, finition mat KIBSA04, gris PVD cod. KIBSA06.  
/ Seifenschale mit Seifenhalter aus Teak Holz, B. 160, H. 28, T. 80 mm. Glänzend KIBSA02, satiniert KIBSA04, grau PVD cod. KIBSA06.  
/ Jabonera apoyado, con balda de madera de teca. L. 160, H. 28, P. 80 mm. Acero inoxidable brillante KIBSA02, satinado KIBSA04, gris PVD cod. KIBSA06.

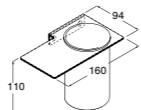

### Blade

/ Porta spazzolini da parete, con bicchiere in vetro pirex L. 160, H. 110, P. 94 mm. Finitura lucida KIBSP01, finitura satinata KIBSP02, grigio PVD cod. KIBSP03.  
/ Wall-mounted tooth-brush holder, with glass in pirex W. 160, H. 110 D. 94 mm. Polished finish KIBSP01, satin finish KIBSP02, PVD grey KIBSP03.  
/ Porte-brosse à dents mural, avec gobelet en pyrex L. 160, H. 110 P. 94 mm. Finition poli KIBSP01, finition mat KIBSP02, gris PVD cod. KIBSP03.  
/ Zahnbürstenhalter mit Becher aus Pirex-Glas L. 160, H. 110, T. 94 mm. Glänzend KIBSP01, satiniert KIBSP02, grau PVD cod. KIBSP03.  
/ Portacepillos de pared, con vaso de vidrio pirex, L. 160, H. 110, P. 94 mm. Acero inoxidable brillante KIBSP01, satinado KIBSP02, gris PVD cod. KIBSP03.

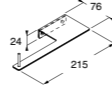

### Blade

/ Porta rotolo L. 215, H. 24, P. 76 mm. Finitura lucida KIBSV06, finitura satinata KIBSV13, grigio PVD cod. KIBRT01.  
/ Toilet-roll holder W. 215, H. 24, D. 76 mm. Polished finish KIBSV06, satin finish KIBSV13, PVD grey KIBRT01.  
/ Porte-rouleau L. 215, H. 24, P. 76 mm. Finition poli KIBSV06, finition mat KIBSV13, gris PVD cod. KIBRT01.  
/ WC-Rollenhalter L. 215, H. 24, T. 76 mm. Glänzend KIBSV06, satiniert KIBSV13, grau PVD cod. KIBRT01.  
/ Portarrollos, L. 215, H. 24, P. 76 mm. Acero inoxidable brillante KIBSV06, satinado KIBSV13, gris PVD cod. KIBRT01.



### Blade

/ Appendi abiti L. 80, H. 44, P. 28 mm. Finitura lucida KIBBT01, finitura satinata KIBBT03, grigio PVD cod. KIBBT05.  
/ Clothes hook W. 80, H. 44, D. 28 mm. Polished finish KIBBT01, satin finish KIBBT03, PVD grey KIBBT05.  
/ Patère L. 80, H. 44, PF. 28 mm. Finition poli KIBBT01, finition mat KIBBT03, gris PVD cod. KIBBT05.  
/ Kleiderhaken L. 80, H. 44, T. 28 mm. Glänzend KIBBT01, satiniert KIBBT03, grau PVD cod. KIBBT05.  
/ Colgador de ropa, L. 80, H. 44, P. 28 mm. Acero inoxidable brillante KIBBT01, satinado KIBBT03, gris PVD cod. KIBBT05.



### Blade

/ Gancio abito L. 80, H. 44, P. 28 mm. Finitura lucida KIBBT02, finitura satinata KIBBT04, grigio PVD cod. KIBBT06.  
/ Wall-mounted hook W. 80, H. 44, D. 28 mm. Polished finish KIBBT02, satin finish KIBBT04, PVD grey KIBBT06.  
/ Crochet L. 80, H. 44, P. 28 mm. Finition poli KIBBT02, finition mat KIBBT04, gris PVD cod. KIBBT06.  
/ Kleiderhaken L. 80, H. 44, T. 28 mm. Glänzend KIBBT02, satiniert KIBBT04, grau PVD cod. KIBBT06.  
/ Gancho colgador, L. 80, H. 44, P. 28 mm. Acero inoxidable brillante KIBBT02, satinado KIBBT04, gris PVD cod. KIBBT06.



### Blade

/ Bicchiere porta spazzolini, in vetro pirex Ø 76, H. 110 mm. KOBSP01.  
/ Tooth-brush holder in pirex glass Ø 76, H. 110 mm. KOBSP01.  
/ Gobelet porte-brosse à dents en pyrex Ø 76, H. 110 mm. KOBSP01.  
/ Zahnbürstenhalter aus Pyrex-Glas Ø 76, H. 110 mm. KOBSP01.  
/ Vaso portacepillos en vidrio Pirex, Ø 76, H. 110 mm. KOBSP01.

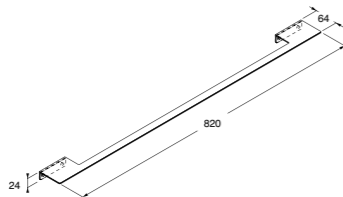

### Blade

/ Porta salvietta, L. 820, H. 24, P. 64 mm. Finitura lucida KIBSV01, finitura satinata KIBSV08, grigio PVD cod. KIBSV19.  
/ Towel rail, W. 820, H. 24 D. 64 mm. Polished finish KIBSV01, satin finish KIBSV08, PVD grey KIBSV19.  
/ Porte-serviette L. 820, H. 24, P. 64 mm. Finition poli KIBSV01, finition mat KIBSV08, gris PVD cod. KIBSV19.  
/ Handtuchhalter L. 820, H. 24, T. 64 mm. Glänzend KIBSV01, satiniert KIBSV08, grau PVD cod. KIBSV19.  
/ Toallero, L. 820, H. 24, P. 64 mm. Acero inoxidable brillante KIBSV01, satinado KIBSV08, gris PVD cod. KIBSV19.

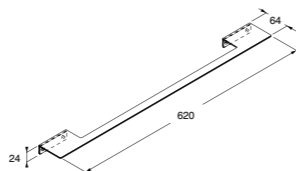

### Blade

/ Porta salvietta, L. 620, H. 24, P. 64 mm. Finitura lucida KIBSV02, finitura satinata KIBSV09, grigio PVD cod. KIBSV18.  
/ Towel rail, W. 620, H. 24, D. 64 mm. Polished finish KIBSV02, satin finish KIBSV09, PVD grey KIBSV18.  
/ Porte-serviette L. 620, H. 24, P. 64 mm. Finition poli KIBSV02, finition mat KIBSV09, gris PVD KIBSV18.  
/ Handtuchhalter L. 620, H. 24, T. 64 mm. Glänzend KIBSV02, satiniert KIBSV09, grau PVD cod. KIBSV18.  
/ Toallero, L. 620, H. 24, P. 64 mm. Acero inoxidable brillante KIBSV02, satinado KIBSV09, gris PVD cod. KIBSV18.

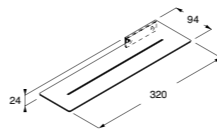

### Blade

/ Mensola per doccia, L. 320, H. 24, P. 94 mm. Finitura lucida KIBME01, finitura satinata KIBME05, grigio PVD cod. KIBME09.  
/ Shower shelf W. 320, H. 24, D. 94 mm. Polished finish KIBME01, satin finish KIBME05, PVD grey KIBME09.  
/ Étagère pour douche L. 320, H. 24, P. 94 mm. Finition poli KIBME01, finition mat KIBME05, gris PVD cod. KIBME09.  
/ Ablage für Dusche L. 320, H. 24, T. 94 mm. Glänzend KIBME01, satiniert KIBME05, grau PVD cod. KIBME09.  
/ Estante para ducha, L. 320, H. 24, P. 94 mm. Acero inoxidable brillante KIBME01, satinado KIBME05, gris PVD cod. KIBME09.

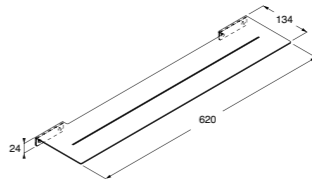

### Blade

/ Mensola L. 620, H. 24, P. 134 mm. Finitura lucida KIBME03, finitura satinata KIBME07, grigio PVD cod. KIBME11.  
/ Shelf W. 620, H. 24, D. 134 mm. Polished finish KIBME03, satin finish KIBME07, PVD grey KIBME11.  
/ Étagère L. 620, H. 24, P. 134 mm. Finition poli KIBME03, finition mat KIBME07, gris PVD cod. KIBME11.  
/ Ablagekonsole L. 620, H. 24, TF. 134 mm. Glänzend KIBME03, satiniert KIBME07, grau PVD cod. KIBME11.  
/ Estante, L. 620, H. 24, P. 134 mm. Acero inoxidable brillante KIBME03, satinado KIBME07, gris PVD cod. KIBME11.

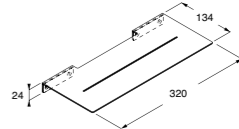

### Blade

/ Mensola L. 320, H. 24, P. 134 mm. Finitura lucida KIBME02, finitura satinata KIBME06, grigio PVD cod. KIBME10.  
/ Shelf, W. 320, H. 24, D. 134 mm. Polished finish KIBME02, satin finish KIBME06, PVD grey cod. KIBME10.  
/ Étagère L. 320, H. 24, P. 134 mm. Finition poli KIBME02, finition mat KIBME06, gris PVD KIBME10.  
/ Ablagekonsole L. 320, H. 24, TF. 134 mm. Glänzend KIBME02, satiniert KIBME06, grau PVD cod. KIBME10.  
/ Estante, L. 320, H. 24, P. 134 mm. Acero inoxidable brillante KIBME02, satinado KIBME06, gris PVD cod. KIBME10.

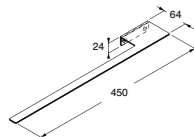

### Blade

/ Porta salvietta, L. 450, H. 24, P. 64 mm. Finitura lucida KIBSV03, finitura satinata KIBSV10, grigio PVD cod. KIBSV16.  
/ Towel rail, W. 450, H. 24, D. 64 mm. Polished finish KIBSV03, satin finish KIBSV10, PVD grey KIBSV16.  
/ Porte-serviette L. 450, H. 24, P. 64 mm. Finition poli KIBSV03, finition mat KIBSV10, gris PVD cod. KIBSV16.  
/ Handtuchhalter L. 450, H. 24, T. 64 mm. Glänzend KIBSV03, satiniert KIBSV10, grau PVD cod. KIBSV16.  
/ Toallero, L. 450, H. 24, P. 64 mm. Acero inoxidable brillante KIBSV03, satinado KIBSV10, gris PVD cod. KIBSV16.

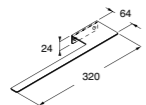

### Blade

/ Porta salvietta, L. 320, H. 24, P. 64 mm. Finitura lucida KIBSV04, finitura satinata KIBSV11, grigio PVD cod. KIBSV15.  
/ Towel rail, W. 320, H. 24, D. 64 mm. Polished finish KIBSV04, satin finish KIBSV11, PVD grey KIBSV15.  
/ Porte-serviette L. 320, H. 24, P. 64 mm. Finition poli KIBSV04, finition mat KIBSV11, gris PVD cod. KIBSV15.  
/ Handtuchhalter L. 320, H. 24, T. 64 mm. Glänzend KIBSV04, satiniert KIBSV11, grau PVD cod. KIBSV15.  
/ Toallero, L. 320, H. 24, P. 64 mm. Acero inoxidable brillante KIBSV04, satinado KIBSV11, gris PVD cod. KIBSV15.

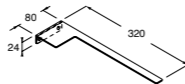

### Blade

/ Porta salvietta a bandiera, L. 320, H. 24, P. 80 mm. Finitura lucida KIBSV05, finitura satinata KIBSV12, grigio PVD cod. KIBSV17.  
/ Towel holder, W. 320, H. 24, D. 80 mm. Polished finish KIBSV05, satin finish KIBSV12, PVD grey KIBSV17.  
/ Porte-serviettes en drapeau L. 320, H. 24, P. 80 mm. Finition poli KIBSV05, finition mat KIBSV12, gris PVD cod. KIBSV17.  
/ Handtuchhalter L. 320, H. 24, T. 80 mm. Glänzend KIBSV05, satiniert KIBSV12, grau PVD cod. KIBSV17.  
/ Toallero de barra, L. 320, H. 24, P. 80 mm. Acero inoxidable brillante KIBSV05, satinado KIBSV12, gris PVD cod. KIBSV17.

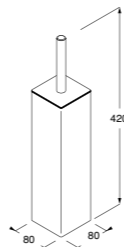

### Blade

/ Porta scopino da parete o d'appoggio L. 80, H. 420, P. 80 mm. Finitura lucida KIBSC01, finitura satinata KIBSC02, grigio PVD cod. KIBSC03.  
/ Wall-mounted or floor mounted brush holder W. 80, H. 420, D. 80 mm. Polished finish KIBSC01, satin finish KIBSC02, PVD grey KIBSC03.  
/ Porte-balai mural ou à poser L. 80, H. 420, P. 80 mm. Finition poli KIBSC01, finition mat KIBSC02, gris PVD cod. KIBSC03.  
/ WC-Bürstengarnitur wandbefestigt oder freistehend L. 80, H. 420, T. 80 mm. Glänzend KIBSC01, satiniert KIBSC02, grau PVD cod. KIBSC03.  
/ Escobillero, apoyado o de pared L. 80, H. 420, P. 80 mm. Acero inoxidable brillante KIBSC01, satinado KIBSC02, gris PVD cod. KIBSC03.

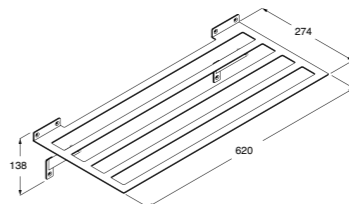

### Blade

/ Griglia porta salviette L. 620, H. 138, P. 274 mm. Finitura lucida KIBSV07, finitura satinata KIBSV14.  
/ Towel rack W. 620, H. 138, D. 274 mm. Polished finish KIBSV07, satin finish KIBSV14.  
/ Grille porte-serviettes L. 620, H. 138, P. 274 mm. Finition poli KIBSV07, finition mat KIBSV14.  
/ Handtuchgitter L. 620, H. 138, T. 274 mm. Glänzend KIBSV07, satiniert KIBSV14.  
/ Toallero repisa L. 620, H. 138, P. 274 mm. Acero inoxidable brillante KIBSV07, satinado KIBSV14.

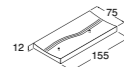

### Blade

/ Appoggio piccolo porta sapone in legno teak L. 155, H. 12, P. 75 mm. Utilizzare come ricambio per cod. KIBSA01/02/03/04. KABAP01.  
/ Small soap-dish, in teak wood W. 155, H. 12, D. 75 mm. To be used as spare part for cod. KIBSA01/02/03/04. KABAP01.  
/ Petit élément porte-savon en teak L. 155, H. 12, PF. 75 mm. Utiliser avec KIBSA01/02/03/04. KABAP01.  
/ Kleine Seifenschale aus Teak Holz L. 155, H. 12, T. 75 mm. Als Austauschartikel verwenden für Code KIBSA01/ 02/03/04. KABAP01.  
/ Balda de madera de teca portajabón. L. 155, H. 12, P. 75 mm. Versión pequeña: utilizable como recambio para artículos KIBSA01/02/03/04. KABAP01.

## Accessori Accessories

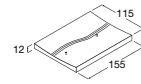

### Blade

/ Appoggio grande porta sapone in legno teak L. 155, H. 12, P. 115 mm. Utilizzare con cod. KIBME02/03/06/07-KIBVA01/02/03/04 - KABAP02.  
/ Big soap-dish, in teak wood W. 155, H. 12, D. 115 mm. To be used with KIBME02/03/06/07 - KIBVA01/03/02/04 - KABAP02.  
/ Grand élément porte-savon en teak L. 155, H. 12, P. 115 mm. Utiliser avec KIBME02/03/06/07 - KIBVA01/03/02/04 - KABAP02.  
/ Grosse Seifenschale aus Teak Holz L. 155, H. 12, T. 115 mm. Verwenden mit KIBME02/03/06/07- KIBVA01/03/02/04 - KABAP02.  
/ Balda de madera de teca porta jabón. L. 155, H. 12, P. 115 mm. Versión grande: utilizable con artículos KIBME02/03/06/07 y KIBVA01/02/03/04 - KABAP02.

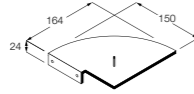

### Blade

/ Mensola d'angolo per doccia L. 150, H. 24, P. 164 mm. Finitura lucida KIBME04, finitura satinata KIBME08, grigio PVD cod. KIBME12.  
/ Corner shelf for shower W. 150, H. 24, D. 164 mm. Polished finish KIBME04, satin finish KIBME08, PVD grey cod. KIBME12.  
/ Étagère d'angle pour douche L. 150, H. 24, P. 164 mm. Finition poli KIBME04, finition mat KIBME08, gris PVD cod. KIBME12.  
/ Eckseifenhalter für Dusche L. 150, H. 24, T. 164 mm. Glänzend KIBME04, satiniert KIBME08, grau PVD cod. KIBME12.  
/ Estante de esquina para ducha, L. 150, H. 24, P. 164 mm. Acero inoxidable brillante KIBME04, satinado KIBME08, gris PVD cod. KIBME12.



### Blade

/ Cestino getta rifiuti con coperchio basculante. Finitura lucida KIBRF01, finitura satinata KIBRF02.  
/ Waste bin with swing lid. Polished finish KIBRF01, satin finish KIBRF02.  
/ Petite corbeille avec couvercle basculant. Finition poli KIBRF01, finition mat KIBRF02.  
/ Abfalleimer mit Schwingdeckel. Glänzend KIBRF01, satiniert KIBRF02.  
/ Papelera con tapa basculante. Acero inoxidable brillante KIBRF01, satinado KIBRF02.

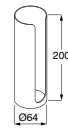

### Blade

/ Porta dischetti make up. Finitura lucida KIBMU01, finitura satinata KIBMU02.  
/ Make up pads holder. Polished finish KIBMU01, satin finish KIBMU02.  
/ Porte-coton démaquillant. Finition poli KIBMU01, finition mat KIBMU02.  
/ Behälter für Watte-Pads. Glänzend KIBMU01, satiniert KIBMU02.  
/ Porta algodones maquillaje. Acero inoxidable brillante KIBMU01, satinado KIBMU02.

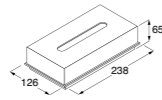

### Blade

/ Porta Kleenex. Finitura lucida KIBKL01, finitura satinata KIBKL02.  
/ Tissue box holder. Polished finish KIBKL01, satin finish KIBKL02.  
/ Porte-Kleenex. Finition poli KIBKL01, finition mat KIBKL02.  
/ Behälter für Reinigungstücher. Glänzend KIBKL01, satiniert KIBKL02.  
/ Porta Kleenex. Acero inoxidable brillante KIBKL01, satinado KIBKL02.

### Floer

/ Accessori bagno in Cristalplant®/marmo/pietra/granito. / Accessories in Cristalplant®/marble/stone/granite. / Accessoires salle de bain en Cristalplant®/marbre/pierre/granite. / Badzubehör aus Cristalplant®/Marmor/Stein/Granit. / Accesorios baño de Cristalplant®/mármol/piedra/granito.

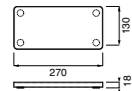

### Floer

/ Portasapone da appoggio. L. 270, P. 130, H. 18 mm. Cristalplant® bianco cod. KMFA01. Marmo bianco Carrara cod. KMFA02. Granito Nero assoluto Zimbabwe cod. KMFA03. Marmo Gris du Marais cod. KMFA04. Granito Black Cosmic cod. KMFA05. Pietra d'Avola cod. KMFA06. Pietra Crema d'Orcia cod. KMFA07.  
/ Top-mounted soap holder. L. 270, P. 130, H. 18 mm. White Cristalplant® cod. KMFA01. White Carrara marble cod. KMFA02. Absolute black Zimbabwe granite cod. KMFA03. Gris du Marais marble cod. KMFA04. Black Cosmic granite cod. KMFA05. Pietra d'Avola stone cod. KMFA06. Crema d'Orcia stone cod. KMFA07.  
/ Porte-savon d'appui. L. 270, P. 130, H. 18 mm. Cristalplant® blanc cod. KMFA01. Marbre blanc Carrara cod. KMFA02. Granite Noir absolu Zimbabwe cod. KMFA03. Marbre Gris du Marais cod. KMFA04. Granite Black Cosmic cod. KMFA05. Pierre d'Avola cod. KMFA06. Pierre Crème d'Orcia cod. KMFA07.

/ Seifenschale, als Aufsatz. L. 270, P. 130, H. 18 mm. Cristalplant® weiß Cod. KMFA01. Marmor weiß Carrara Cod. KMFA02. Granit Tiefschwarz Zimbabwe Cod. KMFA03. Marmor Gris du Marais Cod. KMFA04. Granit Black Cosmic Cod. KMFA05. Stein Pietra D'Avola Cod. KMFA06. Stein Crema d'Orcia Cod. KMFA07.  
/ Jabonera apoyada. L. 270, P. 130, H. 18 mm. Cristalplant® blanco cod. KMFA01. Mármol blanco Carrara od. KMFA02. Granito Negro absoluto Zimbabwe cod. KMFA03. Mármol Gris du Marais cod. KMFA04. Granito Black Cosmic cod. KMFA05. Pietra d'Avola cod. KMFA06. Piedra Crema d'Orcia cod. KMFA07.

### Iko

/ Accessori bagno in tondino di acciaio inox satinato AISI 304, diametro 12 mm. Basamento in pietra Serena. / Bathroom accessories in AISI 304 satin stainless steel rod, diameter 12 mm. Base in Serena stone. / Zubehör für Bäder aus satiniertem Edelstahlrohr AISI 304, Durchmesser 12 mm. Basis aus Stein Serena. / Accesorios baño en redondo de acero inoxidable satinado AISI 304, diámetro 12 mm. Base de piedra Serena.

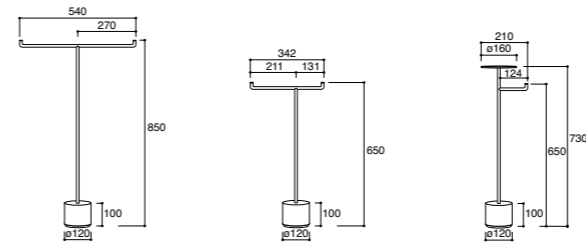

### Iko

/ Piantana da appoggio porta asciugamani, alta L. 540, H. 850 mm. KIISV01. Bassa L. 342, H. 650 mm. KIISV02. Basamento in pietra Serena H. 100, diametro 120 mm.  
/ Tall free-standing towel holder, floor-mounted L. 540, H. 850 mm. KIISV01. Short L. 342, H. 650 mm. KIISV02. Base in Serena stone H. 100, diameter 120 mm.  
/ Colonne porte-serviettes haute, d'appui L. 540, H. 850 mm. KIISV01. Basse L. 342, H. 650 mm. KIISV02. Embase en pierre Serena H. 100, diamètre 120 mm.  
/ Hoher Handtuchständer, als Aufsatz. L. 540, H. 850 mm. KIISV01. Niedriger L. 342, H. 650 mm. KIISV02. Basis aus Stein Serena H. 100, Durchmesser 120 mm.  
/ Toallero de pie alto, apoyado L. 540, H. 850 mm. KIISV01. Bajo L. 342, H. 650 mm. KIISV02. Base de piedra Serena H. 100, diámetro 120 mm.

### Iko

/ Piantana da appoggio porta rotolo. H. 730 mm. KIIRT01. Basamento in pietra Serena H. 100, diametro 120 mm.  
/ Free-standing toilet roll holder, floor-mounted. H. 730 mm. KIIRT01. Base in Serena stone H. 100, diameter 120 mm.  
/ Colonne porte-rouleau, d'appui. H. 730 mm. KIIRT01. Embase en pierre Serena H. 100, diamètre 120 mm.  
/ WC-Rollenständer, als Aufsatz. H. 730 mm. KIIRT01. Basis aus Stein Serena H. 100, Durchmesser 120 mm.  
/ Portarrollos de pie, apoyado H. 730 mm. KIIRT01. Base de piedra Serena H. 100, diámetro 120 mm.

### Minimal

/ Accessori per bagno in acciaio inox AISI 304, finitura satinata. / Bathroom accessories in stainless steel AISI 304, satin finish. / Accessoires de salle de bain en acier inox AISI 304, finition mat. / Zubehör für Bäder aus Edelstahl AISI 304, satiniert. / Accesorios baño de acero inoxidable AISI 304, acabado satinado.

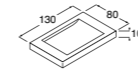

### Minimal

/ Porta sapone da appoggio L. 130, H. 10, P. 80 mm. KIMSA01.  
/ Soap-dish for counter top mounting, W. 130, H. 10, D. 80 mm. KIMSA01.  
/ Porte-savon L. 130, H. 10, P. 80 mm. KIMSA01.  
/ Seifenschale L. 130, H. 10, T. 80 mm. KIMSA01.  
/ Jabonera apoyado L. 130, H. 10, P. 80 mm. KIMSA01.

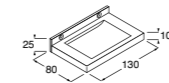

### Minimal

/ Porta sapone da parete L. 130, H. 10, P. 80 mm. KIMSA02.  
/ Wall-mounted soap-dish W. 130, H. 10, D. 80 mm. KIMSA02.  
/ Porte-savon mural L. 130, H. 10, P. 80 mm. KIMSA02.  
/ Wandseifenschale L. 130, H. 10, T. 80 mm. KIMSA02.  
/ Jabonera de pared L. 130, H. 10, P. 80 mm. KIMSA02.

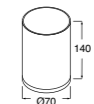

### Minimal

/ Bicchieri porta spazzolini con inserto in ceramica bianca, Ø 70 mm, H. 140 mm. da parete o da appoggio. KIMSP01.  
/ Tooth-brush glass with white ceramic insert, Ø 70 mm, H. 140 mm. for counter top mounting or wall-mounted. KIMSP01.  
/ Gobelet porte-brosses à dents avec insert en céramique blanche, Ø 70 mm, H. 140 mm. mural ou à poser. KIMSP01.  
/ Zahnbürstenbecher Einsatz aus weißer Keramik Ø70 mm, H. 140 mm. Wandbefestigt oder Freistehend. KIMSP01.  
/ Vaso porta cepillos con inserción de cerámica blanca, Ø 70 mm, H. 140 mm. apoyado o de pared. KIMSP01.

## Accessori Accessories

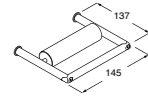

**Minimal**  
/ Porta carta igienica, dimensioni Ø 12 mm, L. 145 mm, P. 137 mm. KIMRT01.  
/ Paper holder, dimensions: Ø 12, W. 145, D. 137 mm. KIMRT01.  
/ Porte-papier hygiénique, dimensions: Ø 12 mm, L. 145 mm, P. 137 mm. KIMRT01.  
/ WC-Rollenhalter, Ø 12 mm, L. 145 mm, T. 137 mm. KIMRT01.  
/ Portarrollos, Ø 12 mm, L. 145 mm, P. 137 mm. KIMRT01.

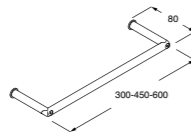

**Minimal**  
/ Porta asciugamani in tondo, dimensioni Ø 12 mm, P. 80 mm, L. 300 mm. KIMSV01 / L. 450 mm. KIMSV02 / L. 600 mm. KIMSV03.  
/ Towel rail in tubular, size Ø 12, D. 80 mm, L. 300 mm. KIMSV01 / L. 450 mm. KIMSV02 / L. 600 mm. KIMSV03.  
/ Porte-serviettes, dimensions Ø 12 mm, P. 80 mm. L. 300 mm. KIMSV01 / L. 450 mm. KIMSV02 / L. 600 mm. KIMSV03.  
/ Röhrenförmiger Handtuchhalter, Ø 12 mm. T. 80 mm. L. 300 mm. KIMSV01 / L. 450 mm. KIMSV02 / L. 600 mm. KIMSV03.  
/ Toallero de pared Ø 12 mm, P. 80 mm, L. 300 mm. KIMSV01 / L. 450 mm. KIMSV02 / L. 600 mm. KIMSV03.



**Minimal**  
/ Porta scopino, con inserto in ceramica bianca, Ø 70 mm, H. 410 mm. da parete o da appoggio. KIMSC01.  
/ Brush holder, with white ceramic insert, Ø 70 mm, H. 410 mm. for floor mounting or wall-mounted. KIMSC01.  
/ Porte-balai avec insert en céramique blanche Ø 70 mm, H. 410 mm. mural ou à poser. KIMSC01.  
/ WC-Bürstengarnitur, mit Einsatz aus weißer Keramik Ø 70 mm, H. 410 mm, wandbefestigt oder freistehend. KIMSC01.  
/ Escobillero con inserción de cerámica blanca. Ø 70 mm, H. 410 mm. Apoyado o de pared. KIMSC01.

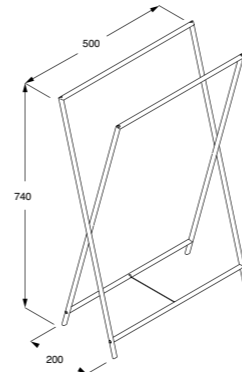

**Minimal**  
/ Portasalviette da terra, H. 740, L. 500, PF. 200 mm. KIMSV08.  
/ Towel holder H. 740, W. 500, D. 200 mm. KIMSV08.  
/ Structure porte-serviettes H. 740, L. 500, PF. 200 mm. KIMSV08.  
/ Handtuchhalter H. 740, L. 500, T. 200 mm. KIMSV08.  
/ Toallero, H. 740, L. 500, P. 200 mm. KIMSV08.

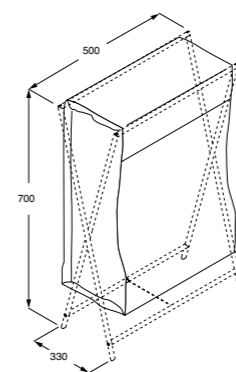

**Minimal**  
/ Sacca portabiancheria in tessuto, da inserire, a richiesta, nel porta salvietta. KIMPB01.  
/ Laundry-sack in cloth. Optional accessory for towel holder. KIMPB01.  
/ Sac porte-linge en tissu, à accrocher, sur demande, au porte-serviettes. KIMPB01.  
/ Wäschesack aus Stoff, Zubehör optional für Handtuchhalter. KIMPB01.  
/ Cesto de ropa en tela. Accesorio opcional para toallero. KIMPB01.

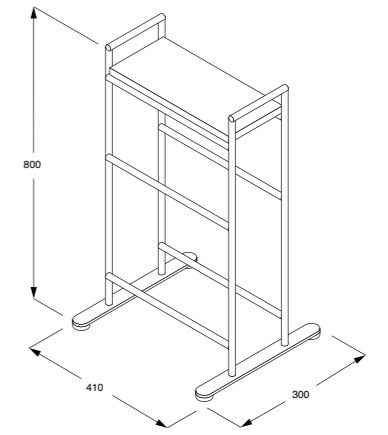

**Minimal**  
/ Piantana porta asciugamani L. 410, H. 800, P. 300 mm, completa di un pianetto in massello di legno KIMSV06.  
/ Freestanding towel holder W. 410, H. 800, D. 300 mm, with a shelf in solid wood KIMSV06.  
/ Structure porte-serviettes L. 410, H. 800, P. 300 mm, avec plan d'appui en bois massif KIMSV06.  
/ Handtuchständer, mit Platte aus massivem Holz B. 410, H. 800, T. 300 mm. KIMSV06.  
/ Toallero de pie, con balda de madera maciza. L. 410, H. 800, P. 300 mm. KIMSV06.



**Minimal**  
/ Porta accappatoio, confezione da 2 pezzi, L. 70 H. 35 P. 80 mm. KIMBT01.  
/ Bathrobe-hook, 2 piece package, W. 70 H. 35 D. 80 mm. KIMBT01.  
/ Porte-peignoir, confection de 2 pièces, L. 70 H. 35 P. 80 mm. KIMBT01.  
/ Bademantelhaken, 2 Stück, L. 70 H. 35 T. 80 mm. KIMBT01.  
/ Percha para albornoz, paquete de 2 piezas, L. 70 H. 35, P. 80 mm. KIMBT01.



**Minimal**  
/ Porta accappatoio singolo, confezione da 2 pezzi, dimensioni Ø 16 mm, L. 35 mm. KIMBT02.  
/ Single bathrobe-hook, 2 piece package, dimension Ø 16 mm, W. 35 mm. KIMBT02.  
/ Porte-peignoir simple, confection de 2 pièces, dimensions Ø 16 mm, L. 35 mm. KIMBT02.  
/ Einzelner Bademantelhaken, 2 Stück, Ø 16 mm, L. 35 mm. KIMBT02.  
/ Percha para albornoz individual, paquete de 2 piezas, Ø 16 mm, L. 35 mm. KIMBT02.

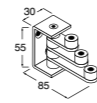

**Minimal**  
/ Porta accappatoio multiplo, ripiegabile a parete, L. 85 mm, H. 55 mm, sp. 30 mm. KIMBT03.  
/ Wall-foldable multiple bathrobe-hook, W. 85, H. 55 mm, D. 30 mm. KIMBT03.  
/ Porte-peignoir à plusieurs patères, repliable vers le mur, L. 85 mm, H. 55 mm, ép. 30 mm. KIMBT03.  
/ Mehrfacher Bademantelhaken, ausschwenkbar B. 35, H. 55 mm, ST. 30 mm. KIMBT03.  
/ Percha para albornoz múltiple, plegable. L. 85 mm, H. 55 mm, SP. 30 mm. KIMBT03.

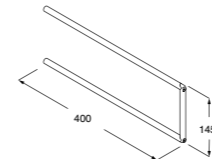

**Minimal**  
/ Porta asciugamani verticale Ø 12, H. 145, P. 400 mm. KIMSV05.  
/ Vertical towel-rail Ø 12, H. 145, D. 400 mm. KIMSV05.  
/ Porte-serviettes vertical Ø 12, H. 145, P. 400 mm. KIMSV05.  
/ Vertikaler Handtuchhalter Ø 12 mm, H. 145, T. 400 mm. KIMSV05.  
/ Toallero vertical, Ø 12, H. 145, P. 400 mm. KIMSV05.

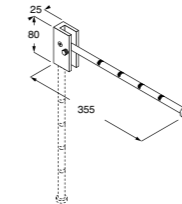

**Minimal**  
/ Stendino ripiegabile, per 4 grucce, L. 355 aperto H. 80, P. 25 mm. KIMSD01.  
/ Foldable clothes-drier, for 4 coat hangers W. 355, unfolded H. 80, D. 25 mm. KIMSD01.  
/ Etendoir pliable, pour 4 cintres L. 355 ouvert H. 80, P. 25 mm. KIMSD01.  
/ Ausklappbarer Kleiderhaken für 4 Kleiderbügel L. 355 ausgeklappt, H. 80, T. 25 mm. KIMSD01.  
/ Tendadero plegable para 4 perchas, L. 355 H. 80, P. 25 mm. KIMSD01.

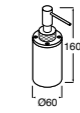

**Minimal**  
/ Dispenser da appoggio in DERLIN bianco. KIMDS01.  
/ Dispenser, for counter top mounting, in white DERLIN. KIMDS01.  
/ Distributeur à poser en DERLIN blanc. KIMDS01.  
/ Seifenspender, aus DERLIN weiß. KIMDS01.  
/ Dosificador de jabón en DERLIN blanco. KIMDS01.



**Minimal**  
/ Porta rotolo di scorta in tondo, Ø 30, prof. 125 mm. KIMBT04.  
/ Holder for spare toilet-roll in tubular, Ø 30, D. 125 mm. KIMBT04.  
/ Extendable magnifying mirror with aluminium frame. One side is a regular mirror, and the reverse side provides 2X magnification. Extends min. 150 mm, max 650 mm. from the wall. H. 405 mm. KIMSE01.  
/ Miroir grossissant extensible, cadre en aluminium, miroir, grossissant d'un côté, normal de l'autre extension max. 650 mm. H. 405 mm. extension min. 150 mm. KIMSE01.  
/ Teleskop-Kosmetikwandspiegel mit Einrahmung aus Aluminium. Eine Seite mit zwei Vergrößerungen und eine Seite Normalansicht. Ausschwenkbar mind. 150 mm, max 650 mm. H. 405 mm. KIMSE01.  
/ Espejo de aumento extensible con marco de aluminio. Un lado de dos aumentos, un lado normal. Extensión min. 150 mm, máx 650 mm. H. 405 mm. KIMSE01.

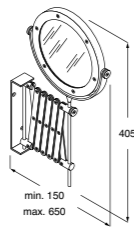

**Minimal**  
/ Specchio ingranditore estensibile, cornice in alluminio, specchio da un lato ingranditore, da un lato normale, max. estensione 650 mm, H. 405 mm, min. estensione 150 mm. KIMSE01.  
/ Extendable magnifying mirror with aluminium frame. One side is a regular mirror, and the reverse side provides 2X magnification. Extends min. 150 mm, max 650 mm. from the wall. H. 405 mm. KIMSE01.  
/ Miroir grossissant extensible, cadre en aluminium, miroir, grossissant d'un côté, normal de l'autre extension max. 650 mm. H. 405 mm. extension min. 150 mm. KIMSE01.  
/ Teleskop-Kosmetikwandspiegel mit Einrahmung aus Aluminium. Eine Seite mit zwei Vergrößerungen und eine Seite Normalansicht. Ausschwenkbar mind. 150 mm, max 650 mm. H. 405 mm. KIMSE01.  
/ Espejo de aumento extensible con marco de aluminio. Un lado de dos aumentos, un lado normal. Extensión min. 150 mm, máx 650 mm. H. 405 mm. KIMSE01.

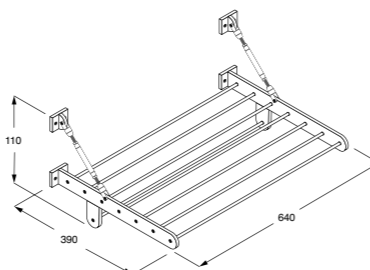

**Minimal**  
/ Griglia porta asciugamani L. 640, H. 110, PF. 390 mm. KIMSV04.  
/ Towel-rack W. 640, H. 110, D. 390 mm. KIMSV04.  
/ Grille porte-serviettes L. 640 H. 110 prof. 390 mm. KIMSV04.  
/ Handtuchgitter wandbefestigt L. 640, H. 110, T. 390 mm. KIMSV04.  
/ Toallero repisa, L. 640, H. 110, P. 390 mm. KIMSV04.



## Accessori Accessories

### Pipe

/ Accessori per bagno in acciaio inox AISI 304. / Bathroom accessories in stainless steel AISI 304. / Accessoires de salle de bain en acier inox AISI 304. / Zubehör für Bäder aus Edelstahl AISI 304. / Accesorios baño de acero inoxidable AISI 304.

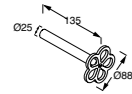

### Pipe

/ Porta rotolo. Inox satinato + rosso cod. KIPRT01.  
/ Toilet roll holder. Satin stainless steel + red cod. KIPRT01.  
/ Porte-rouleau. Inox satiné + rouge cod. KIPRT01.  
/ WC-Rollenhalter. Edelstahl satiniert + rot. Cod. KIPRT01.  
/ Portarrollos. Inox satinado + rojo cod. KIPRT01.



### Pipe

/ Porta asciugamani. Inox satinato + rosso cod. KIPSV01.  
/ Towel holder. Satin stainless steel + red cod. KIPSV01.  
/ Porte-serviettes. Inox satiné + rouge cod. KIPSV01.  
/ Handtuchhalter. Edelstahl satiniert + rot. Cod. KIPSV01.  
/ Toallero. Inox satinado + rojo cod. KIPSV01.



### Pipe

/ Porta abiti. Inox satinato + rosso cod. KIPBT01.  
/ Clothes hook. Satin stainless steel + red cod. KIPBT01.  
/ Crochet porte-vêtements. Inox satiné + rouge cod. KIPBT01.  
/ Kleiderhaken. Edelstahl satiniert + rot. Cod. KIPBT01.  
/ Gancho colgador. Inox satinado + rojo cod. KIPBT01.

### RL11

/ Accessori per bagno in ceramica smaltata bianco lucido. / Bathroom accessories in white polished enameled ceramic. / Accessoires de salle de bain en céramique émaillée blanc poli. / Zubehör für Bäder aus weißer Keramik, glasiert und glänzend. / Accesorios baño de cerámica esmaltada blanco brillante.

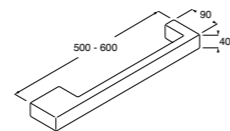
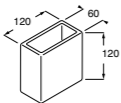
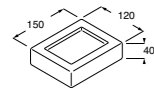

### RL11

/ Porta sapone L. 150, H. 40, P. 120 mm, da piano KERSA01 / da parete, KERSA02.  
/ Soap-dish for counter top mounting W. 150, H.40, D. 120 mm. KERSA01 / wall-mounted soap-dish KERSA02.  
/ Porte-savon L. 150, H. 40, ép. 120 mm. KERSA01 / porte-savon mural, KERSA02.  
/ Seifenschale L. 150, H. 40, T. 120 mm. KERSA01 / Wand-seifenschale KERSA02.  
/ Jabonera, L. 150, H. 40, P. 120 mm, apoyado KERSA01 / de pared, KERSA02.

### RL11

/ Porta spazzolini L. 120, H. 120, PF. 60 mm, da parete KERSPO2 / da piano, KERSPO1.  
/ Wall-mounted tooth-brush holder W. 120, H. 120, D. 60 mm, KERSPO2 / for counter top mounting KERSPO1.  
/ Porte-brosses à dents mural L. 120, H. 120, PF. 60 mm, KERSPO2 / à poser, KERSPO1.  
/ Wandzahnbürstenhalter L. 120, H. 120, T. 60 mm, KERSPO2 / Zahnbürstenhalter, KERSPO1.  
/ Portacepillos, L. 120, H. 120, P. 60 mm, apoyado KERSPO2 / de pared, KERSPO1.

### RL11

/ Porta salviette 500 x 90 x H. 40 mm. KERSV01 / 600 x 90 x 40 mm. KERSV02.  
/ Towel-rail 500 x 90 x H. 40 mm. KERSV01 / 600 x 90 x 40 mm. KERSV02.  
/ Porte-serviettes 500 x 90 x H. 40 mm. KERSV01 / 600 x 90 x 40 mm. KERSV02.  
/ Handtuchhalter 500 x 90 x H. 40 mm. KERSV01 / 600 x 90 x 40 mm. KERSV02.  
/ Toallero 500 x 90 x H. 40 mm. KERSV01 / 600 x 90 x 40 mm. KERSV02.

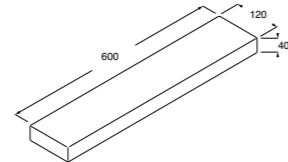
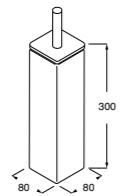
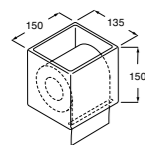

### RL11

/ Porta rotolo da parete 135 x 150 x H. 150 mm. KERRT01.  
/ Wall-mounted toilet-roll holder 135 x 150 x H. 150 mm. KERRT01.  
/ Porte-rouleau mural 135 x 150 x H. 150 mm. KERRT01.  
/ WC-Rollenhalter 135 x 150 x H. 150 mm. KERRT01.  
/ Portarrollos 135 x 150 x H. 150 mm. KERRT01.

### RL11

/ Porta scopino 80 x 80 x H. 300 mm. da parete KERSCO2, da appoggio KERSCO1.  
/ Toilet brush holder 80 x 80 x H. 300 mm. wall-mounted KERSCO2, floor-mounted KERSCO1.  
/ Porte-balai 80 x 80 x H. 300 mm. mural KERSCO2, d'appui KERSCO1.  
/ WC-Bürstengarnitur 80 x 80 x H. 300 mm. wandbefestigt KERSCO2, bodenbefestigt KERSCO1.  
/ Escobillero 80 x 80 x H. 300 mm. de pared KERSCO2, apoyado KERSCO1.

### RL11

/ Mensola L. 600, H. 40, PF. 120 mm. KERME01.  
/ Shelf, W. 600, H. 40, D. 120 mm. KERME01.  
/ Tablette mural L. 600, H. 40, ÉP. 120 mm. KERME01.  
/ Ablagekonsole B. 600, H. 40, T. 120 mm. KERME01.  
/ Repisa L. 600, H. 40, P. 120 mm. KERME01.

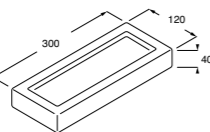
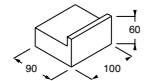

### RL11

/ Porta abiti L. 100, H. 60, PF. 90 mm. KERBT01.  
/ Clothes hook W. 100, H. 60, D. 90 mm. KERBT01.  
/ Porte-vêtements L. 100, H. 60, ÉP. 90 mm. KERBT01.  
/ Kleiderhaken B. 100, H. 60, T. 90 mm. KERBT01.  
/ Percha L. 100, H. 60, P. 90 mm. KERBT01.

### RL11

/ Porta oggetti L. 300, H. 40, PF. 120 mm. KERGG01.  
/ Storage tray W. 300, H. 40, D. 120 mm. KERGG01.  
/ Porte-objets L. 300, H. 40, ÉP. 120 mm. KERGG01.  
/ Ablagekonsole B. 300, H. 40, T. 120 mm. KERGG01.  
/ Porta objetos L. 300, H. 40, P. 120 mm. KERGG01.

### Shortcut

/ Serie di portasalvietta da terra, realizzati in tondino di acciaio AISI 304, Ø 10 mm, verniciati con polveri epossidiche colore bianco opaco. / Towel holders, made of Ø10 mm. rod in stainless steel AISI 304, varnished with epoxy powder, mat white. / Série de porte-serviette sur pied, réalisés en fil d'acier AISI 304, Ø 10 mm, peints avec poudres époxydiques couleur blanc mat. / Serie von bodenbefestigten Handtuchhalter aus Rundstahl Ø10 mm, Edelstahl AISI 304, lackiert mit Epoxy-Pulver, in den Farben weiß matt. / Toalleros de acero inoxidable AISI 304, acabado blanco mate, diámetro 10 mm. Pintados con polvos epoxídicos.

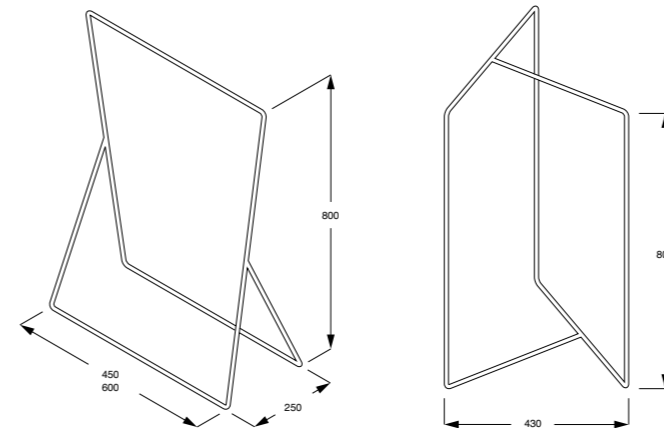

### Shortcut

/ Porta salvietta da terra H. 800, L. 450 mm. KESSV01; H. 800, L. 600 mm. KESSV02; H. 800, L. 430 mm. KESSV03.  
/ Floor-mounted towel holder H. 800, L. 450 mm. KESSV01; H. 800, L. 600 mm. KESSV02; H. 800, L. 430 mm. KESSV03.  
/ Porte-serviettes sur pied H. 800, L. 450 mm. KESSV01; H. 800, L. 600 mm. KESSV02; H. 800, L. 430 mm. KESSV03.  
/ Bodenbefestigter Handtuchhalter H. 800, L. 450 mm. KESSV01; H. 800, L. 600 mm. KESSV02; H. 800, L. 430 mm. KESSV03.  
/ Toallero apoyado H. 800, L. 450 mm. KESSV01; H. 800, L. 600 mm. KESSV02; H. 800, L. 430 mm. KESSV03.

### Skyline

/ Accessori bagno in Corian® bianco. / Bathroom accessories in white Corian®. / Accessoires salle de bains en Corian® blanc. / Zubehör für Bäder aus Corian® weiß. / Accesorios baño en Corian® blanco.

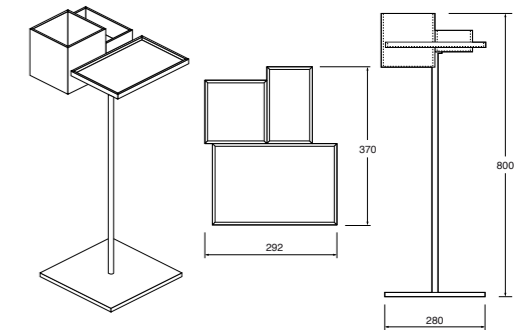
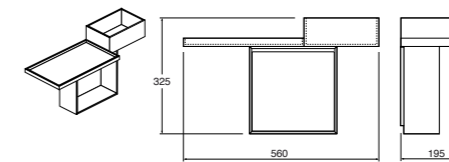
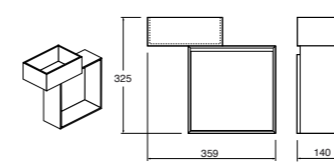

### Skyline

/ Contenitore pensile a 2 vani, L. 359, H. 325, P. 140 mm. KNYBX02.  
/ Wall-mounted cabinet with 2 compartments, W. 359, H. 325, D. 140 mm. KNYBX02.  
/ Élément haut à 2 compartiments, L. 359, H. 325, ÉP. 140 mm. KNYBX02.  
/ Hängeschrank mit 2 Fächern, B. 359, H. 325, T. 140 mm. KNYBX02.  
/ Contenedor alto de 2 compartimentos, L. 359, H. 325, P. 140 mm. KNYBX02.

### Skyline

/ Contenitore pensile a 3 vani, L. 560, H. 325, P. 195 mm. KNYBX01.  
/ Wall-mounted cabinet with 3 compartments, W. 560, H. 325, D. 195 mm. KNYBX01.  
/ Élément haut à 3 compartiments, L. 560, H. 325, ÉP. 195 mm. KNYBX01.  
/ Hängeschrank mit 3 Fächern, B. 560, H. 325, T. 195 mm. KNYBX01.  
/ Contenedor alto de 3 compartimentos, L. 560, H. 325, P. 195 mm. KNYBX01.

### Skyline

/ Contenitore piantana a 3 vani, L. 292, H. 800, P. 370 mm. KNYBY01.  
/ Floor-mounted basement with 3 compartments, W. 292, H. 800, D. 370 mm. KNYBY01.  
/ Élément colonne à 3 compartiments, L. 292, H. 800, ÉP. 370 mm. KNYBY01.  
/ Bodenständer mit 3 Fächern, B. 292, H. 800, T. 370 mm. KNYBY01.  
/ Contenedor de pie de 3 compartimientos, L. 292, H. 800, P. 370 mm. KNYBY01.

## Accessori Accessories

### Twig

/ Accessori da bagno in legno massello Iroko, Cristalplant® bianco e acciaio inox con trattamento PVD o verniciato. / Accessories in Iroko solid wood, white Cristalplant® and stainless steel treated with PVD coating technology or painted. / Accessoires salle de bain en bois massif Iroko, Cristalplant® blanc et acier inox avec traitement PVD ou peint. / Badzubehör in Massivholz Iroko, Cristalplant® weiß und Edelstahl mit PVD-Beschichtung oder lackiert. / Accesorios de baño de madera maciza Iroko, Cristalplant® blanco y acero inoxidable con tratamiento PVD o pintado.

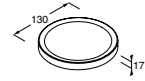

### Twig

/ Porta sapone da appoggio in Cristalplant® bianco. Fondo antiscivolo in gomma EPDM. Cod. KPWSA01.  
/ Soap holder in white Cristalplant®. Anti-slip bottom made of EPDM rubber. Cod. KPWSA01.  
/ Porte-savon d'appui en Cristalplant® blanc. Fond antidérapant en caoutchouc EPDM. Cod. KPWSA01.  
/ Seifenschale aus weißem Cristalplant®. Auflage aus rutschfestem EPDM-Gummi. Cod. KPWSA01.  
/ Jabonera apoyado realizado de Cristalplant® blanco. Fondo antideslizante de goma EPDM. Cod. KPWSA01.

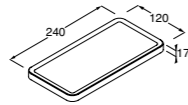

### Twig

/ Vassoio da appoggio in Cristalplant® bianco. Fondo antiscivolo in gomma EPDM. Cod. KPWVA01.  
/ Tray in white Cristalplant®. Anti-slip bottom made of EPDM rubber. Cod. KPWVA01.  
/ Plateau d'appui en Cristalplant® blanc. Fond antidérapant en caoutchouc EPDM. Cod. KPWVA01.  
/ Tablett aus weißem Cristalplant®. Auflage aus rutschfestem EPDM-Gummi. Cod. KPWVA01.  
/ Bandeja apoyado realizado de Cristalplant® blanco. Fondo antideslizante de goma EPDM. Cod. KPWVA01.

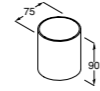

### Twig

/ Porta spazzolino da appoggio in Cristalplant® bianco. Fondo antiscivolo in gomma EPDM. Cod. KPWSP01.  
/ Toothbrush holder in white Cristalplant®. Anti-slip bottom made of EPDM rubber. Cod. KPWSP01.  
/ Porte brosse à dents d'appui en Cristalplant® blanc. Fond antidérapant en caoutchouc EPDM. Cod. KPWSP01.  
/ Zahnbecher aus weißem Cristalplant®. Auflage aus rutschfestem EPDM-Gummi. Cod. KPWSP01.  
/ Porta cepillo apoyado realizado de Cristalplant® blanco. Fondo antideslizante de goma EPDM. Cod. KPWSP01.

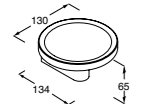

### Twig

/ Porta sapone da parete in Cristalplant® bianco. Supporto in legno massello Iroko. Cod. KPWSA02.  
/ Wall soap holder in white Cristalplant®. Support in Iroko solid wood. Cod. KPWSA02.  
/ Plateau porte-savon mural en Cristalplant® blanc. Support en bois massif Iroko. Cod. KPWSA02.  
/ Seifenschale, Wandausführung aus weißem Cristalplant®. Träger aus Massivholz Iroko. Cod. KPWSA02.  
/ Jabonera de pared. Bandeja jabonera de Cristalplant® blanco. Soporte de madera maciza Iroko. Cod. KPWSA02.

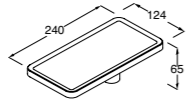

### Twig

/ Mensola in Cristalplant® bianco. Supporto in legno massello Iroko. Cod. KPWME01.  
/ Shelf in white Cristalplant®. Support in Iroko solid wood. Cod. KPWME01.  
/ Tablette en Cristalplant® blanc. Support en bois massif Iroko. Cod. KPWME01.  
/ Regal aus weißem Cristalplant®. Träger aus Massivholz Iroko. Cod. KPWME01.  
/ Ménsula de Cristalplant® blanco. Soporte de madera maciza Iroko. Cod. KPWME01.

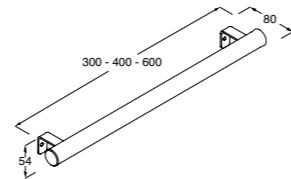

### Twig

/ Asta porta asciugamani da parete in legno massello Iroko. Supporti in acciaio inox con trattamento PVD colore grigio. L. 300 mm. cod. KLWSV01. L. 400 mm. cod. KLWSV02. L. 600 mm. cod. KLWSV03.  
/ Wall-mounted rod for towel in solid Iroko wood. Supports in stainless steel, treated with grey PVD technology. L. 300 mm. cod. KLWSV01. L. 400 mm. cod. KLWSV02. L. 600 mm. cod. KLWSV03.  
/ Porte-serviettes murale en bois massif Iroko. Support en acier avec traitement PVD couleur gris. L. 300 mm. cod. KLWSV01. L. 400 mm. cod. KLWSV02. L. 600 mm. cod. KLWSV03.  
/ Handtuchstange, Wandausführung. Handtuchhalter aus Massivholz Iroko. Edelstahlträger mit grauer PVD-Beschichtung. L. 300 mm. cod. KLWSV01. L. 400 mm. cod. KLWSV02. L. 600 mm. cod. KLWSV03.  
/ Toallero de pared de madera maciza Iroko. Soportes de acero inoxidable con tratamiento PVD color gris. L. 300 mm. cod. KLWSV01. L. 400 mm. cod. KLWSV02. L. 600 mm. cod. KLWSV03.

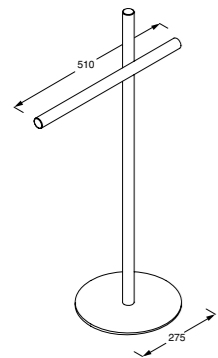

### Twig

/ Piantana portasciugamani. Aste in legno massello Iroko. Basamento in acciaio inox con trattamento PVD colore grigio. Fondo antiscivolo in gomma EPDM. Cod. KLWSV05.  
/ Free standing towel holder. Rods in solid Iroko wood. Base in stainless steel treated with grey PVD technology. Anti-slip bottom made of EPDM rubber. Cod. KLWSV05.  
/ Colonne porte-serviettes. Tiges en bois massif Iroko. Embase en acier inox avec traitement PVD couleur grise. Fond antidérapant en caoutchouc EPDM. Cod. KLWSV05.  
/ Handtuchständer. Stäbe aus Massivholz Iroko. Boden in Edelstahl mit grauer PVD-Beschichtung. Auflage aus rutschfestem EPDM-Gummi. Cod. KLWSV05.  
/ Toallero de pie. Barras de madera maciza Iroko. Base de acero inoxidable con tratamiento PVD color gris. Fondo antideslizante de goma EPDM. Cod. KLWSV05.

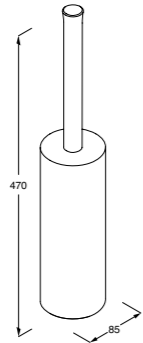

### Twig

/ Porta scopino, da appoggio e da muro. Contenitore in acciaio inox verniciato bianco opaco. Manico in legno massello Iroko. Cod. KVWSC01.  
/ Toilet brush holder, free standing and wall-mounted. Body in stainless steel, matt white painted. Handle in solid Iroko wood. Cod. KVWSC01.  
/ Porte-balai d'appui et mural. Caisson en acier inox peint blanc mat. Manche en bois massif Iroko. Cod. KVWSC01.  
/ WC-Bürstengarnitur, Aufsatz- oder Wandausführung. Behälter in Edelstahl mattweiß lackiert. Griff aus Massivholz Iroko. Cod. KVWSC01.  
/ Escobillero, apoyado o de pared. Mueble contenedor de acero inoxidable pintado blanco mate. Mango de madera maciza Iroko. Cod. KVWSC01.

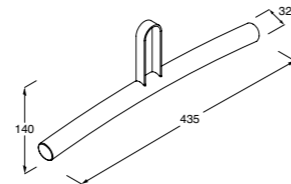

### Twig

/ Gruccia per porta abiti in legno massello Iroko. Fascia per aggancio a porta abiti in cuoio. Cod. KLWGR01.  
/ Coat hanger made of Iroko solid wood. Hook in leather. Cod. KLWGR01.  
/ Cintre pour porte-vêtements en bois massif Iroko. Bande-au pour fixation à porte-vêtements en cuir. Cod. KLWGR01.  
/ Bügel für Kleiderhaken aus Massivholz Iroko. Leder-schleufe zum Einhängen an Kleiderhaken. Cod. KLWGR01.  
/ Percha para colgador realizado de madera maciza Iroko. Banda de cuero para enganchar a colgador. Cod. KLWGR01.



### Twig

/ Porta abiti in legno massello Iroko. Cod. KLWBT01.  
/ Clothes hook. Made of Iroko solid wood. Cod. KLWBT01.  
/ Porte-vêtements. Réalisé en bois massif Iroko. Cod. KLWBT01.  
/ Kleiderhaken aus Massivholz Iroko. Cod. KLWBT01.  
/ Colgador realizado de madera maciza Iroko. Cod. KLWBT01.

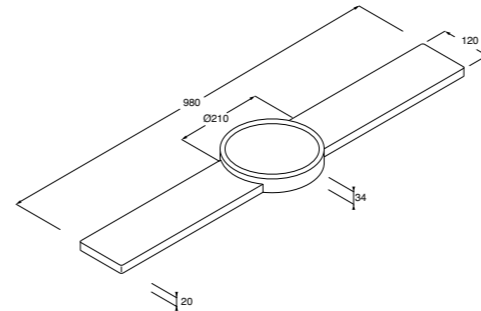

### Twig

/ Mensola in legno massello Iroko per vasca, con pianetto in Corian® bianco. L. 980, P. 120 mm, cod. KLWME01.  
/ Bathtub shelf in solid Iroko wood, with flat plate in white Corian®. L. 980, P. 120 mm, cod. KLWME01.  
/ Tablette en bois massif Iroko pour baignoire, avec petit plan en Corian® blanc. L. 980, P. 120 mm, cod. KLWME01.  
/ Wannenregal in Massivholz Iroko, mit Ablage aus weißem Corian®. L. 980, P. 120 mm, cod. KLWME01.  
/ Estante para bañera de madera maciza Iroko, con balda de Corian® blanca. L. 980, P. 120 mm, cod. KLWME01.

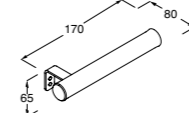

### Twig

/ Porta rotolo. Supporto in acciaio inox con trattamento PVD colore grigio. Asta in legno massello Iroko. Cod. KLWRT01.  
/ Toilet roll holder. Support in stainless steel, treated with grey PVD technology. Rod in solid Iroko wood. Cod. KLWRT01.  
/ Porte-rouleau. Support en acier avec traitement PVD couleur gris. Tige en bois massif Iroko. Cod. KLWRT01.  
/ WC-Rollenhalter. Edelstahlträger mit grauer PVD-Beschichtung. Stab aus Massivholz Iroko. Cod. KLWRT01.  
/ Portarrollos. Soporte de acero inoxidable con tratamiento PVD color gris. Barra de madera maciza Iroko. Cod. KLWRT01.

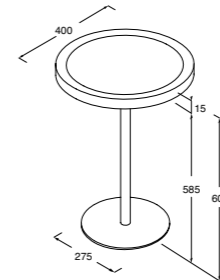

### Twig

/ Tavolino. Piano in Cristalplant® bianco. Asta di sostegno in legno massello Iroko. Basamento in acciaio inox con trattamento PVD colore grigio. Cod. KPWAV01.  
/ Small table. Top in white Cristalplant®. Leg in solid Iroko wood. Base in stainless steel treated with grey PVD technology. Cod. KPWAV01.  
/ Petite table. Plan en Cristalplant® blanc. Tige de soutien en bois massif Iroko. Embase en acier inox avec traitement PVD couleur grise. Cod. KPWAV01.  
/ Tisch. Waschtischplatte aus weißem Cristalplant®. Tischbein aus Massivholz Iroko. Boden in Edelstahl mit grauer PVD-Beschichtung. Cod. KPWAV01.  
/ Mesita. Encimera de Cristalplant® blanco. Barra de soporte de madera maciza Iroko. Base de acero inoxidable con tratamiento PVD color gris. Cod. KPWAV01.

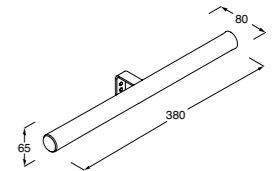

### Twig

/ Porta rotolo con portasciugamani. Supporto in acciaio inox con trattamento PVD colore grigio. Asta in legno massello Iroko. Cod. KLWSV04.  
/ Toilet roll holder with towel holder. Support in stainless steel, treated with grey PVD technology. Rod in solid Iroko wood. Cod. KLWSV04.  
/ Porte-rouleau avec porte-serviettes. Support en acier avec traitement PVD couleur gris. Tige en bois massif Iroko. Cod. KLWSV04.  
/ WC-Rollenhalter mit Handtuchstange. Edelstahlträger mit grauer PVD-Beschichtung. Stab aus Massivholz Iroko. Cod. KLWSV04.  
/ Portarrollos con toallero. Soporte de acero inoxidable con tratamiento PVD color gris. Barra de madera maciza Iroko. Cod. KLWSV04.

## Complementi, Specchi, Lampade Complementary Items, Mirrors, Lamps

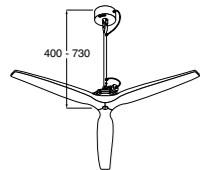

### Air

/ Ventilatore agitatore da soffitto con pala in legno o verniciato nero Ø 1600 mm, meccanica Vortice, senza telecomando a raggi infrarossi, attivabile con regolatori di velocità lineari a più posizioni, a cura del cliente. 220-240 V. - 50Hz. Finitura acciaio inox AISI 304. H. 400 mm. GRCB07/ H. 730 mm. GRCB08 / H. 1200 mm. GRCB09. 110 - 125 V. - 60 Hz H. 400 mm. GRCB10 / H. 730 mm. GRCB11 / H. 1200 mm. GRCB12. ATTENZIONE: per adempiere alle norme UE 61/28 la parte inferiore della pala deve risultare a un'altezza uguale o superiore a 2300 mm. dal piano di calpestio.

/ Ceiling fan with wood or varnished black vane Ø 1600 mm, Vortice engine, without infra-red radio controller. It can start up with linear speed regulators with different positions, by client. 220 - 240 V. - 50 Hz AISI 304 stainless steel finish H. 400 mm. GRCB07 / H. 730 mm. GRCB08 / H. 1200 mm. GRCB09. 110 - 125 V. - 60 Hz H. 400 mm. GRCB10 / H. 730 mm. GRCB11 / H. 1200 mm. GRCB12. ATTENTION: in compliance with EU 61/28 the lower part of the vane has to be 2300 mm. or higher.

/ Ventilateur agitateur à fixer au plafond avec pales en bois naturel ou vernis noir Ø 1600 mm, mécanisme Vortice, sans télécommande à rayons infrarouges, l'installation d'un régulateur de vitesse multi position est à charge du client. 220-240 V. - 50 Hz Finition acier inox AISI 304. H. 400 mm. GRCB07 / H. 730mm. GRCB08/H.1200mm. GRCB09. 110-125V.-60Hz H. 400 mm. GRCB10 / H. 730 mm. GRCB11 / H. 1200 mm. GRCB12. ATTENTION: selon les normes européennes UE 61/28 la partie inférieure de la pale doit être placée à une hauteur supérieure ou égale à 2300 mm. du sol.

/ Deckenventilator mit Flügeln aus Naturholz oder schwarz lackiert Ø 1600 mm, Mechanik Vortice, ohne Infrarot-Fernbedienung, aktivierbar durch lineare Geschwindigkeitsregler auf mehrere Stufen Auf eigene Beschaffung des Kunden. 220 - 240 V. - 50Hz. Ausführung in Edelstahl AISI 304. H. 400 mm. GRCB07 / H. 730 mm. GRCB08 / H. 1200 mm. GRCB09. 110 - 125 V. - 60 Hz H. 400 mm. GRCB10 / H. 730 mm. GRCB11 / H. 1200 mm. GRCB12. ACHTUNG: Nach der Norm UE 61/28 muß der untere Teil des Ventilators 2300 mm. oder höher über dem Boden angebracht werden.

/ Ventilador agitador de techo con pala en madera Ø 1600 mm. mecánica Vortice, sin mando a distancia de rayos infrarrojos, activable con reguladores de velocidad lineales con más posiciones, a cargo del cliente. 220-240 V - 50 Hz. Acabado acero inox AISI 304. H. 400 mm. GRCB07 / H. 730 mm. GRCB08 / H. 1200 mm. GRCB09. 110-125 V - 60 Hz. H. 400 mm. GRCB10 / H. 730 mm. GRCB11 / H. 1200 mm. GRCB12. CUIDADO: para cumplir con las normas CEE 61/28 la parte inferior de la pala tiene que estar a una altura igual o superior a los 2300 mm. de la base de pisada.

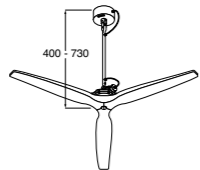

### Air

/ Ventilatore agitatore da soffitto con pala in legno o verniciato nero Ø 1600 mm, meccanica Vortice, con telecomando a raggi infrarossi, 5 velocità. 220-240 V. - 50 Hz. Finitura acciaio inox AISI 304. H. 400 mm. GRCB01 / H. 730 mm. GRCB02 / H. 1200 mm. GRCB03. Versione con invertitore di rotazione pala e telecomando: H. 400 mm. GRCB21 / H. 730 mm. GRCB22 / H. 1200 mm. GRCB23. 110-125 V.- 60 Hz H. 400 mm. GRCB04 / H. 730 mm. GRCB05 / H. 1200 mm. GRCB06. Versione con invertitore di rotazione pala e telecomando: H. 400 mm. GRCB24 / H. 730 mm. GRCB25 / H. 1200 mm. GRCB26. ATTENZIONE: per adempiere alle norme UE 61/28 la parte inferiore della pala deve risultare a un'altezza uguale o superiore a 2300 mm. dal piano di calpestio.

/ Ceiling fan with wood or varnished black vane Ø 1600 mm, Vortice engine, with infra-red radio controller, 5 speeds. 220-240V. - 50 Hz. AISI 304 stainless steel finish. H. 400 mm. GRCB01 / H. 730 mm. GRCB02 / H. 1200 mm. GRCB03. Version with switcher for reversal of rotation and radio controller: H. 400 mm. GRCB21 / H. 730 mm. GRCB22 / H. 1200 mm. GRCB23. 110-125 V. - 60 Hz H. 400 mm. GRCB04 / H. 730 mm. GRCB05 / H. 1200 mm. GRCB06. Version with switcher for reversal of rotation and radio controller: H. 400 mm. GRCB24 / H. 730 mm. GRCB25 / H. 1200 mm. GRCB26. ATTENTION: in compliance with EU 61/28 the lower part of the vane has to be 2300 mm. or higher.

/ Ventilateur agitateur à fixer au plafond avec pales en bois naturel ou vernis noir Ø 1600 mm, mécanisme Vortice, avec télécommande à rayons infrarouges, 5 vitesses. 220-240 V. - 50 Hz. Finition acier inox AISI 304. H. 400 mm. GRCB01 / H. 730 mm. GRCB02 / H. 1200 mm. GRCB03. Version avec inversion rotation gicleur et télécommande : H. 400 mm. GRCB21 / H. 730 mm. GRCB22 / H. 1200 mm. GRCB23. 110-125 V. - 60 Hz H. 400 mm. GRCB04 / H. 730 mm. GRCB05 / H. 1200 mm. GRCB06. Version avec inversion rotation gicleur et télécommande : H. 400 mm. GRCB24 / H. 730 mm. GRCB25 / H. 1200 mm. GRCB26. ATTENTION : selon les normes européennes UE 61/28 la partie inférieure de la pale doit être placée à une hauteur supérieure ou égale à 2300 mm. du sol.

/ Deckenventilator mit Flügeln aus Naturholz oder schwarz lackiert Ø 1600 mm, Mechanik Vortice, mit Infrarot Fernbedienung, 5 Geschwindigkeitsstufen. 220-240V. - 50Hz. Ausführung in Edelstahl AISI 304. H. 400 mm. GRCB01 / H. 730 mm. GRCB02 / H. 1200 mm. GRCB03. Version mit Flügelrotationswender und Fernbedienung: H. 400 mm. GRCB21 / H. 730 mm. GRCB22 / H. 1200 mm. GRCB23. 110 -125 V. - 60 Hz H. 400 mm. GRCB04 / H. 730 mm. GRCB05 / H. 1200 mm. GRCB06. Version mit Flügelrotationswender und Fernbedienung: H. 400 mm. GRCB24 / H. 730 mm. GRCB25 / H. 1200 mm. GRCB26. ACHTUNG: Nach der Norm UE 61/28 muß der untere Teil des Ventilators 2300 mm. oder höher über dem Boden angebracht werden.

/ Ventilador agitador de techo con pala en madera Ø 1600 mm, mecánica Vortice, con mando a distancia de rayos infrarrojos, 5 velocidades. 220-240 V - 50 Hz. Acabado acero inox AISI 304. H. 400 mm. GRCB01 / H. 730 mm. GRCB02 / H. 1200 mm. GRCB03. Version con inversor de rotación pala y mando: H. 400 mm. GRCB21 / H. 730 mm. GRCB22 / H. 1200 mm. GRCB23. 110-125 V - 60 Hz. H. 400 mm. GRCB04 / H. 730 mm. GRCB05 / H. 1200 mm. GRCB06. Version con inversor de rotación pala y mando: H. 400 mm. GRCB24 / H. 730 mm. GRCB25 / H. 1200 mm. GRCB26. CUIDADO: para cumplir con las normas CEE 61/28 la parte inferior de la pala tiene que estar a una altura igual o superior a los 2300 mm. de la base de pisada.

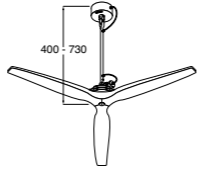

### Air

/ Ventilatore agitatore da soffitto con pala in legno verniciato opaco nero o bianco Ø 1600 mm, meccanica Vortice, con telecomando a raggi infrarossi, 5 velocità. 220-240 V. - 50 Hz. Finitura acciaio verniciato opaco. Bianco: H. 380 mm. GRDP01 / H. 530 mm. GRDP02 / H. 930 mm. GRDP03 / H. 1200 mm. GRDP04. Nero: altezza 380 mm. GRDQ01 / H. 530 mm. GRDQ02 / H. 930 mm. GRDQ03 / H. 1200 mm. GRDQ04. 110-125 V. - 60 Hz. bianco: H. 380 mm. GRDP09 / H. 530 mm. GRDP10 / H. 930 mm. GRDP11 / altezza 1200 mm. GRDP12. Nero: H. 380 mm. GRDQ09 / H. 530 mm. GRDQ10 / H. 930 mm. GRDQ11 / H. 1200 mm. GRDQ12. ATTENZIONE: per adempiere alle norme UE 61/28 la parte inferiore della pala deve risultare a un'altezza uguale o superiore a 2300 mm. dal piano di calpestio.

/ Ceiling fan with black or white matt painted vane Ø 1600 mm, Vortice engine, with infra-red radio controller, 5 speeds. 220-240 V. - 50 Hz. Steel, matt painted finish. White: H. 380 mm. GRDP01 / H. 530 mm. GRDP02 / H. 930 mm. GRDP03 / H. 1200 mm. GRDP04. Black: H. 380 mm. GRDQ01 / H. 530 mm. GRDQ02 / H. 930 mm. GRDQ03 / H. 1200 mm. GRDQ04. 110-125 V. - 60 Hz, white: H. 380 mm. GRDP09 / H. 530 mm. GRDP10 / H. 930 mm. GRDP11 / H. 1200 mm. GRDP12. Black: H. 380 mm. GRDQ09 / H. 530 mm. GRDQ10 / H. 930 mm. GRDQ11 / H. 1200 mm. GRDQ12. ATTENTION: in compliance with EU 61/28 the lower part of the vane has to be 2300 mm. or higher.

/ Ventilateur agitateur à fixer au plafond avec pales en bois, peint mat blanc ou noir Ø 1600 mm, mécanisme Vortice, avec télécommande à rayons infrarouges, 5 vitesses. 220-240 V. - 50 Hz. Finition acier peint mat. Blanc: H. 380 mm. GRDP01 / H. 530 mm. GRDP02 / H. 930 mm. GRDP03 / H. 1200 mm. GRDP04. Noir: H. 380 mm. GRDQ01 / H. 530 mm. GRDQ02 / H. 930 mm. GRDQ03 / H. 1200 mm. GRDQ04. 110-125 V. - 60 Hz, blanc: H. 380 mm. GRDP09 / H. 530 mm. GRDP10 / H. 930 mm. GRDP11 / H. 1200 mm. GRDP12. Noir: H. 380 mm. GRDQ09 / H. 530 mm. GRDQ10 / H. 930 mm. GRDQ11 / H. 1200 mm. GRDQ12. ATTENTION: selon les normes européennes UE 61/28 la partie inférieure de la pale doit être placée à une hauteur supérieure ou égale à 2300 mm. du sol.

/ Deckenventilator mit Flügeln aus Holz, matt weiß oder schwarz lackiert Ø 1600 mm, Mechanik Vortice, mit Infrarot-Fernbedienung, 5 Geschwindigkeitsstufen. 220-240V. - 50Hz. Ausführung in Stahl, matt lackiert. Weiß: H. 380 mm. GRDP01 / H. 530 mm. GRDP02 / H. 930 mm. GRDP03 / H. 1200 mm. GRDP04. Schwarz: H. 380 mm. GRDQ01 / H. 530 mm. GRDQ02 / H. 930 mm. GRDQ03 / H. 1200 mm. GRDQ04. 110-125 V. - 60 Hz, weiß: H. 380 mm. GRDP09 / H. 530 mm. GRDP10 / H. 930 mm. GRDP11 / H. 1200 mm. GRDP12. Schwarz: H. 380 mm. GRDQ09 / H. 530 mm. GRDQ10 / H. 930 mm. GRDQ11 / H. 1200 mm. GRDQ12. ACHTUNG: Nach der Norm UE 61/28 muß der untere Teil des Ventilators 2300 mm. oder höher über dem Boden angebracht werden.

/ Ventilador agitador de techo con pala de madera barnizada blanco mate o negro Ø 1600 mm, mecánica Vortice, con mando a distancia de rayos infrarrojos, 5 velocidades. 220-240 V - 50 Hz. Acabado acero pintado mate. Blanco: H. 380 mm. GRDP01 / H. 530 mm. GRDP02 / H. 930 mm. GRDP03 / H. 1200 mm. GRDP04. Negro: H. 380 mm. GRDQ01 / H. 530 mm. GRDQ02 / H. 930 mm. GRDQ03 / H. 1200 mm. GRDQ04. 110-125 V. - 60 Hz, blanco: H. 380 mm. GRDP09 / H. 530 mm. GRDP10 / H. 930 mm. GRDP11 / H. 1200 mm. GRDP12. Negro: H. 380 mm. GRDQ09 / H. 530 mm. GRDQ10 / H. 930 mm. GRDQ11 / H. 1200 mm. GRDQ12. CUIDADO: para cumplir con las normas CEE 61/28 la parte inferior de la pala tiene que estar a una altura igual o superior a los 2300 mm. de la base de pisada.

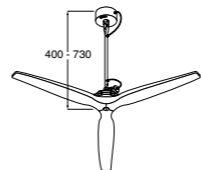

### Air St

/ Ventilatore agitatore da soffitto con pala in legno verniciato opaco nero o bianco Ø 1600 mm, meccanica Vortice, senza telecomando a raggi infrarossi, attivabile con regolatori di velocità lineari a più posizioni, a cura del cliente. 220-240 V. - 50 Hz. Finitura acciaio verniciato opaco. Bianco: H. 380 mm. GRDP05 / H. 530 mm. GRDP06 / H. 930 mm. GRDP07 / H. 1200 mm. GRDP08. Nero: H. 380 mm. GRDQ05 / H. 530 mm. GRDQ06 / H. 930 mm. GRDQ07 / H. 1200 mm. GRDQ08. 110-125 V.- 60 Hz, bianco: H. 380 mm. GRDP13 / H. 530 mm. GRDP14 / H. 930 mm. GRDP15 / H. 1200 mm. GRDP16. Nero: H. 380 mm. GRDQ13 / H. 530 mm. GRDQ14 / H. 930 mm. GRDQ15 / H. 1200 mm. GRDQ16. ATTENZIONE: per adempiere alle norme UE 61/28 la parte inferiore della pala deve risultare a un'altezza uguale o superiore a 2300 mm. dal piano di calpestio.

/ Ceiling fan with black or white matt painted vane Ø 1600 mm, Vortice engine, without infra-red radio controller. It can start up with linear speed regulators with different positions, by client. 220-240 V. - 50 Hz. Steel, matt painted finish. White: H. 380 mm. GRDP05 / H. 530 mm. GRDP06 / H. 930 mm. GRDP07 / H. 1200 mm. GRDP08. Black: H. 380 mm. GRDQ05 / H. 530 mm. GRDQ06 / H. 930 mm. GRDQ07 / H. 1200 mm. GRDQ08. 110-125 V. - 60 Hz, white: H. 380 mm. GRDP13 / H. 530 mm. GRDP14 / H. 930 mm. GRDP15 / H. 1200 mm. GRDP16. Black: H. 380 mm. GRDQ13 / H. 530 mm. GRDQ14 / H. 930 mm. GRDQ15 / H. 1200 mm. GRDQ16. ATTENTION: in compliance with EU 61/28 the lower part of the vane has to be 2300 mm. or higher.

/ Ventilateur agitateur à fixer au plafond avec pales en bois, peint mat blanc ou noir Ø 1600 mm, mécanisme Vortice, sans télécommande à rayons infrarouges, l'installation d'un régulateur de vitesse multi position est à charge du client. 220-240 V. - 50 Hz. Finition acier peint mat. Blanc: H. 380 mm. GRDP05 / H. 530 mm. GRDP06 / H. 930 mm. GRDP07 / H. 1200 mm. GRDP08. Noir: H. 380 mm. GRDQ05 / H. 530 mm. GRDQ06 / H. 930 mm. GRDQ07 / H. 1200 mm. GRDQ08. 110-125 V.- 60 Hz, blanc: H. 380 mm. GRDP13 / H. 530 mm. GRDP14 / H. 930 mm. GRDP15 / H. 1200 mm. GRDP16. Noir: H. 380 mm. GRDQ13 / H. 530 mm. GRDQ14 / H. 930 mm. GRDQ15 / H. 1200 mm. GRDQ16. ATTENTION: selon les normes européennes UE 61/28 la partie inférieure de la pale doit être placée à une hauteur supérieure ou égale à 2300 mm. du sol.

/ Deckenventilator mit Flügeln aus Holz, matt weiß oder schwarz lackiert Ø 1600 mm, Mechanik Vortice, ohne Infrarot-Fernbedienung, aktivierbar durch lineare Geschwindigkeitsregler auf mehrere Stufen Auf eigene Beschaffung des Kunden. 220-240V. - 50Hz. Ausführung in Stahl, matt lackiert. Weiß: H. 380 mm. GRDP05 / H. 530 mm. GRDP06 / H. 930 mm. GRDP07 / H. 1200 mm. GRDP08. Schwarz: H. 380 mm. GRDQ05 / H. 530 mm. GRDQ06 / H. 930 mm. GRDQ07 / H. 1200 mm. GRDQ08. 110-125 V. - 60 Hz, weiß: H. 380 mm. GRDP13 / H. 530 mm. GRDP14 / H. 930 mm. GRDP15 / H. 1200 mm. GRDP16. Schwarz: H. 380 mm. GRDQ13 / H. 530 mm. GRDQ14 / H. 930 mm. GRDQ15 / H. 1200 mm. GRDQ16. ACHTUNG: Nach der Norm UE 61/28 muß der untere Teil des Ventilators 2300 mm. oder höher über dem Boden angebracht werden.

/ Ventilador agitador de techo con pala de madera barnizada blanco mate o negro Ø 1600 mm, mecánica Vortice, sin mando a distancia de rayos infrarrojos, activable con reguladores de velocidad lineales con más posiciones, a cargo del cliente. 220-240 V - 50 Hz. Acabado acero pintado mate. Blanco: H. 380 mm. GRDP05 / H. 530 mm. GRDP06 / H. 930 mm. GRDP07 / H. 1200 mm. GRDP08. Negro: H. 380 mm. GRDQ05 / H. 530 mm. GRDQ06 / H. 930 mm. GRDQ07 / H. 1200 mm. GRDQ08. 110-125 V. - 60 Hz, blanco: H. 380 mm. GRDP13 / H. 530 mm. GRDP14 / H. 930 mm. GRDP15 / H. 1200 mm. GRDP16. Negro: H. 380 mm. GRDQ13 / H. 530 mm. GRDQ14 / H. 930 mm. GRDQ15 / H. 1200 mm. GRDQ16. CUIDADO: para cumplir con las normas CEE 61/28 la parte inferior de la pala tiene que estar a una altura igual o superior a los 2300 mm. de la base de pisada.

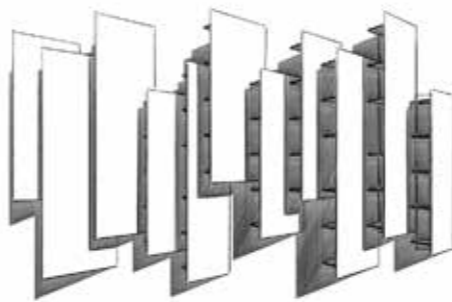

## Complementi, Specchi, Lampade Complementary Items, Mirrors, Lamps

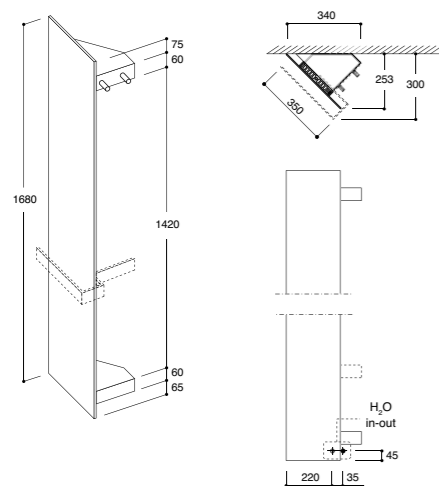

### Ct Line Termo

/ Termoarredo ad acqua calda, reversibile. Materiale: 95% alluminio + 5% acciaio, verniciato a polveri epossidiche. Resa termica (t 50): 507 watt / 436 Kcalh / 1730 BTU. Attacchi: 1/2" (valvola e detentore esclusi). Completo di doppio porta accappatoio. Accessori porta salviette opzionali, da ordinare separatamente. L. 340, P. 253, H. 1680 mm. Versioni: bianco RAL 9003, CCGDF036, colore speciale (a scelta da tabella colori speciali CTLine Termo) CCGDW036. E' possibile realizzare composizioni accostando tra loro 2 o più termoarredo.

/ Radiator, hot water version, reversible. Material: 95% aluminium + 5% steel, painted with epoxy powders. Thermal performance (t 50): 507 watt / 436 Kcalh / 1730 BTU. Connections: 1/2" (valve and lockshield valve excluded). With two bathrobe hooks. Optional towel holders, to be ordered separately. L. 340, P. 253, H. 1680 mm. Versions: white RAL 9003, CCGDF036, special colour (colour to be chosen only from CTLINE TERMO special colours chart) CCGDW036. It's possible to match 2 or more radiators creating compositions.

/ Radiateur décoratif à eau chaude, réversible. Matériau: 95% aluminium + 5% acier, peint avec poudres époxydes. Rendement thermique (t 50): 507 watt / 436 Kcalh / 1730 BTU. Attaches: 1/2" (valve et détendeur exclus). Muni de double porte-peignoir. Accessoires porte-serviettes en option, à commander séparément. L. 340, P. 253, H. 1680 mm. Versions : blanc RAL 9003, CCGDF036, couleur spéciale (seulement couleur au choix dans le tableau couleurs spéciales CTLINE TERMO) CCGDW036. Il est possible de réaliser des compositions en juxtaposant entre eux 2 ou plusieurs radiateurs décoratifs.

/ Design-Heizkörper mit Warmwasserbetrieb, wendbar. Material: 95% Aluminium + 5% Stahl, Epoxidpulverlackierung. Wärmeleistung (t 50): 507 Watt / 436 Kcalh / 1730 BTU. Anschlüsse: 1/2" (Rücklaufverschraubung). Mit zwei Bademantelhaltern. Handtuchhalter optional, sind getrennt zu bestellen. L. 340, P. 253, H. 1680 mm. Versionen : weiß RAL 9003, CCGDF036, Sonderfarbe (nur Farbe aus Sonder-Musterfarben CTLINE TERMO) CCGDW036. Man kann Kompositionen bilden, indem zwischen ihnen 2 oder mehr Design-Heizkörper angestellt werden.

/ Radiador de agua caliente, reversible. Material: 95% aluminio + 5% acero, pintado con polvos epoxidicos. Rendimiento térmico (t 50): 507 watt / 436 Kcalh / 1730 BTU. Uniones: 1/2" (válvula y detentor excluidos). Equipado con doble porta albornoz. Accesorios toalleros opcionales, a pedir por separado. L. 340, P. 253, H. 1680 mm. Versiones: blanco RAL 9003, CCGDF036, color especial (solo color a elección en la tabla colores especiales CTLINE TERMO) CCGDW036. Es posible realizar composiciones acoplado entre ellos 2 o varios radiadores.

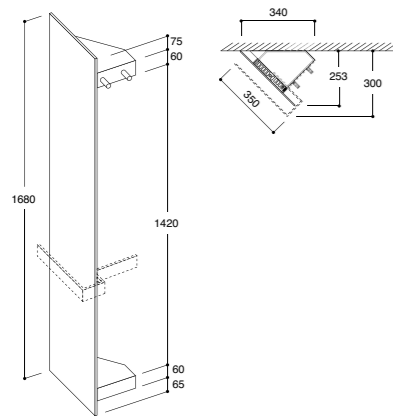

### Ct Line Termo

/ Termoarredo elettrico, reversibile. Materiale: 95% alluminio + 5% acciaio, verniciato a polveri epossidiche. Resa termica - assorbimento: max 500 watt (resistenza a secco). Completo di doppio porta accappatoio. Accessori porta salviette opzionali, da ordinare separatamente. L. 340, P. 253, H. 1680 mm. Versioni - Europa: bianco RAL 9003, CCGDE036, colore speciale (a scelta da tabella colori speciali CTLine Termo) CCGDV036. E' possibile realizzare composizioni accostando tra loro 2 o più termoarredo.

/ Electrical radiator, reversible. Material: 95% aluminium + 5% steel, painted with epoxy powders. Thermal performance - absorption: max 500 watt (resistance without liquids). With two bathrobe hooks. Optional towel holders, to be ordered separately. L. 340, P. 253, H. 1680 mm. Versions - Europe: white RAL 9003, CCGDE036, special colour (colour to be chosen only from CTLINE TERMO special colours chart) CCGDV036. It's possible to match 2 or more radiators creating compositions.

/ Radiateur décoratif électrique, réversible. Matériau: 95% aluminium + 5% acier, peint avec poudres époxydes. Rendement thermique - absorption max 500 watt (résistance à sec). Muni de double porte-peignoir. Accessoires porte-serviettes en option, à commander séparément. L. 340, P. 253, H. 1680 mm. Versions : blanc RAL 9003, CCGDE036, couleur spéciale (seulement couleur au choix dans le tableau couleurs spéciales CTLINE TERMO) CCGDV036. Il est possible de réaliser des compositions en juxtaposant entre eux 2 ou plusieurs radiateurs décoratifs.

/ Design-Heizkörper mit Elektrobetrieb, wendbar. Material: 95% Aluminium + 5% Stahl, Epoxidpulverlackierung. Wärmeleistung - Aufnahme: max 500 Watt (Trockenwiderstand). Mit zwei Bademantelhaltern. Handtuchhalter optional, sind getrennt zu bestellen. L. 340, P. 253, H. 1680 mm. Versionen - Europa: weiß RAL 9003, CCGDE036, Sonderfarbe (nur Farbe aus Sonder-Musterfarben CTLINE TERMO) CCGDV036. Man kann Kompositionen bilden, indem zwischen ihnen 2 oder mehr Design-Heizkörper angestellt werden.

/ Radiador eléctrico, reversible. Material: 95% aluminio + 5% acero, pintado con polvos epoxidicos. Rendimiento térmico - absorción: máx 500 watt (resistencia en seco). Equipado con doble porta albornoz. Accesorios toalleros opcionales, a pedir por separado. L. 340, P. 253, H. 1680 mm. Versiones - Europa: blanco RAL 9003, CCGDE036, color especial (solo color a elección en la tabla colores especiales CTLINE TERMO) CCGDV036. Es posible realizar composiciones acoplado entre ellos 2 o varios radiadores.

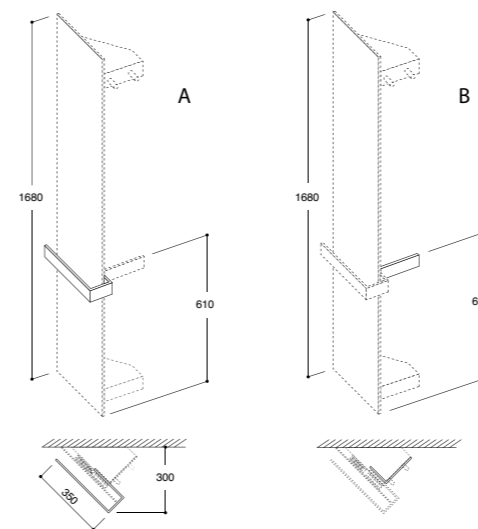

### Ct Line Termo

/ Accessorio reversibile opzionale porta salviette in alluminio verniciato a polveri epossidiche. Compatibile con termoarredo dal funzionamento ad acqua calda o elettrico. A discrezione del progettista si possono montare entrambi i porta salviette oppure uno solo dei due. Tipo A, esterno, bianco RAL 9003, KVNSV02 colore speciale, KVNSV04. Tipo B, interno, bianco RAL 9003 KVNSV01 colore speciale, KVNSV03.

/ Optional, reversible towel holder in aluminium painted with epoxy powders. Compatible with thermo heating system - working with hot water or electric. It's possible to have both towel holders or one only, according to designer's choice. Type A, external, white RAL 9003, KVNSV02 special colour, KVNSV04. Type B, internal, white RAL 9003 KVNSV01 special colour, KVNSV03.

/ Accessoire porte-serviettes, réversible en option. Matériau: aluminium peint avec poudres époxydes. Compatible avec radiateur décoratif avec fonctionnement à eau chaude ou électrique. Au choix du concepteur un ou deux porte-serviettes peuvent être montés. Type A, externe, blanc RAL 9003, KVNSV02 couleur spéciale, KVNSV04. Type B, interne, blanc RAL 9003 KVNSV01 couleur spéciale, KVNSV03.

/ Handtuchhalter optional, wendbar, aus Aluminium Epoxidpulverlackierung. Kompatibel mit Design-Heizkörper mit Warmwasser- oder Elektrobetrieb. Je nach Planung sind beide Handtuchhalter oder nur einer der beiden montierbar. Typ A, außen, weiß RAL 9003, KVNSV02 Sonderfarbe, KVNSV04. Typ B, innen, weiß RAL 9003 KVNSV01 Sonderfarbe, KVNSV03.

/ Accessorio opcional toallero, reversibile. Material: aluminio pintado con polvos epoxidicos. Compatible con radiador que funciona con agua caliente o eléctrico. A discreción del diseñador se pueden montar ambos toalleros o uno solo de los dos. Tipo A, exterior, blanco RAL 9003, KVNSV02 color especial, KVNSV04. Tipo B, interior, blanco RAL 9003 KVNSV01 color especial, KVNSV03.

### Glass

/ Contenitori pensili a giorno in vetro temperato trasparente con schienale verniciato (bianco, grigio, nero, rosso o specchio). / Open-faced wall units in tempered transparent glass with painted back panel (white, grey, black, red or mirror). / Éléments hauts ouverts en verre trempé transparent avec panneau de fond peint (blanc, gris, noir, rouge, miroir). / Hängeschränk offen aus transparentem Hartglas mit Rückwand lackiert (weiß, grau, schwarz, rot, Spiegel). / Muebles altos abiertos de vidrio templado transparente con panel trasero pintado (blanco, gris, negro, rojo, espejo).

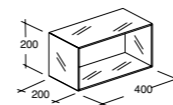

### Glass

/ Pensile a giorno 1 vano, L. 400 mm, H. 200 mm. PLCA040N.  
/ Open-faced wall unit, 1 compartment, W. 400 mm, H. 200 mm. PLCA040N.  
/ Élément haut ouvert à 1 compartiment, L. 400 mm, H. 200 mm. PLCA040N.  
/ Schrank mit 1 offenem Fächern, B. 400 mm, H. 200 mm. PLCA040N.  
/ Mueble alto abierto - 1 compartimiento, L. 400 mm, H. 200 mm. PLCA040N.

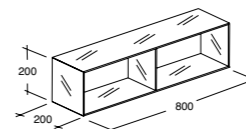

### Glass

/ Pensile a giorno 2 vani, L. 800 mm, H. 200 mm. PLCA080N.  
/ Open-faced wall unit, 2 compartments, W. 800 mm, H. 200 mm. PLCA080N.  
/ Élément haut ouvert à 2 compartiments, L. 800 mm, H. 200 mm. PLCA080N.  
/ Schrank mit 2 offenen Fächern, B. 800 mm, H. 200 mm. PLCA080N.  
/ Mueble alto abierto - 2 compartimentos, L. 800 mm, H. 200 mm. PLCA080N.

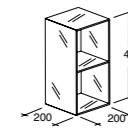

### Glass

/ Pensile a giorno 2 vani, L. 200 mm, H. 400 mm. PPCMA020N.  
/ Open-faced wall unit 2 compartments, W. 200 mm, H. 400 mm. PPCMA020N.  
/ Élément haut ouvert à 2 compartiments, L. 200 mm, H. 400 mm. PPCMA020N.  
/ Schrank mit 2 offenen Fächern, B. 200 mm, H. 400 mm. PPCMA020N.  
/ Mueble alto abierto - 2 compartimientos, L. 200 mm, H. 400 mm. PPCMA020N.

**Complementi, Specchi, Lampade**  
Complementary Items, Mirrors, Lamps

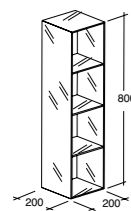

**Glass**

/ Pensile a giorno 4 vani, L. 200 mm, H. 800 mm. PECMA020N.  
/ Open-faced wall unit, 4 compartments, W. 200 mm, H. 800 mm. PECMA020N.  
/ Élément haut ouvert à 4 compartiments, L. 200 mm, H. 800 mm. PECMA020N.  
/ Schrank mit 4 offenen Fächern, B. 200 mm, H. 800 mm. PECMA020N.  
/ Mueble alto abierto - 4 compartimientos, L. 200 mm, H. 800 mm. PECMA020N.

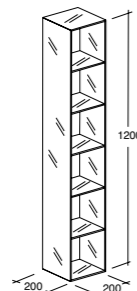

**Glass**

/ Pensile a giorno 6 vani, L. 200 mm, H. 1200 mm, P. 200 mm. PJCMA020N.  
/ Open-faced wall unit, 6 compartments, W. 200 mm, H. 1200 mm, D. 200 mm. PJCMA020N.  
/ Élément haut ouvert à 6 compartiments, L. 200 mm, H. 1200 mm, P. 200 mm. PJCMA020N.  
/ Schrank mit 6 offenen Fächern, B. 200 mm, H. 1200 mm, T. 200 mm. PJCMA020N.  
/ Mueble alto abierto - 6 compartimientos, L. 200 mm, H. 1200 mm, P. 200 mm. PJCMA020N.

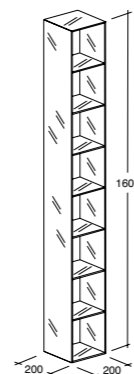

**Glass**

/ Pensile a giorno 8 vani, L. 200 mm, H. 1600 mm, P. 200 mm. PNCMA020N.  
/ Open-faced wall unit, 8 compartments, W. 200 mm, H. 1600 mm, D. 200 mm. PNCMA020N.  
/ Élément haut ouvert à 8 compartiments, L. 200 mm, H. 1600 mm, P. 200 mm. PNCMA020N.  
/ Schrank mit 8 offenen Fächern, B. 200 mm, H. 1600 mm, T. 200 mm. PNCMA020N.  
/ Mueble alto abierto - 8 compartimientos, L. 200 mm, H. 1600 mm, P. 200 mm. PNCMA020N.

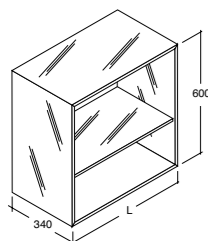

**Glass**

/ Contenitore a giorno d'appoggio sovrato in vetro, L. 600 mm, H. 600 mm, P. 340 mm. PBHMA60N / L. 900 mm. PBHMA90N.  
/ Glass open-faced unit for counter top mounting, H. 600 mm, W. 600 mm, D. 340 mm. PBHMA60N / W. 900 mm. PBHMA90N.  
/ Élément ouvert d'appui sur top en verre, L. 600 mm, H. 600 mm, P. 340 mm. PBHMA60N / L. 900 mm. PBHMA90N.  
/ Aufsatz-Schränkelement aus Glas, H. 600 mm, B. 600 mm, T. 340 mm. PBHMA60N / B. 900 mm. PBHMA90N.  
/ Mueble contenedor abierto, apoyado, L. 600 mm, H. 600 mm, P. 340 mm. PBHMA60N / L. 900 mm. PBHMA90N.

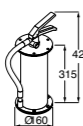

**\* Fire**

/ Estintore, per uso domestico, contenitore porta estintore in acciaio inox, staffa di fissaggio a parete, contenuto 2 kg idrocarburi alogenati. GVCF01.  
/ Domestic extinguisher, external carcass in stainless steel, wall fixing bracket, 2 kg halogenous hydrocarbons. GVCF01.  
/ Extincteur à usage domestique, récipient porte extincteur en acier inox, étrier pour fixation murale, capacité 2 kg hydrocarbures halogénées. GVCF01.  
/ Feuerlöscher für den häuslichen Gebrauch - Feuerlöscher umgebender Korpus aus Edelstahl, Aufhängebügel zur Wandbefestigung, Gewicht: 2kg, halogenierte Kohlenwasserstoffgase. GVCF01.  
/ Extintor, para uso doméstico, contenedor porta extintor en acero inox abrazadera de fijación a pared, contenido 2 kg. Hidrocarburos halogenados. GVCF01.

/

\* Disponibile fino ad esaurimento scorte  
Available until stock lasts

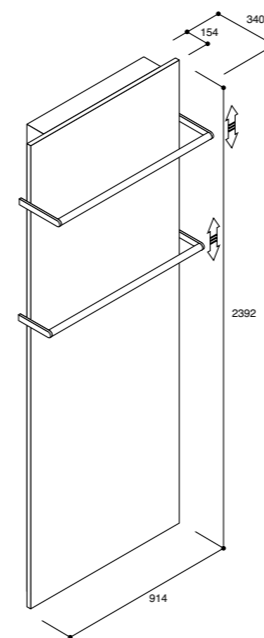

**Origine**

/ Struttura fitness attrezzabile. Spalliera a parete costituita da pannello frontale in finitura specchio o Lasermat, struttura in alluminio, 2 maniglioni frontali scorrevoli (con bloccaggio) in acciaio rivestito in legno verniciato nero opaco. L. 914, P. 340, H. 2392 mm. Specchio GXDR01, Lasermat GXDR02.  
/ Fitness equipment, which can be fitted with accessories. Wall bars composed of front panel made of mirror or Lasermat, structure in aluminium, 2 steel frontal sliding bars (with lock) covered in matt black painted wood. L. 914, P. 340, H. 2392 mm. Mirror GXDR01, Lasermat GXDR02.  
/ Structure fitness accessoirisable. Espalier mural : panneau frontal avec finition miroir ou Lasermat, structure en aluminium, 2 grosses poignées coulissantes devant (avec blocage) en acier revêtu en bois peint noir mat. L. 914, P. 340, H. 2392 mm. Miroir GXDR01, Lasermat GXDR02.  
/ Ausrüstbare Sportwand. Sprossenwand bestehend aus Frontpaneel in der Ausführung Spiegel oder Lasermat, Gestell aus Aluminium, 2 verschiebbare Frontstahlstangen, Ummantelung aus schwarz lackiertem Holz (mit Blockierung). L. 914, P. 340, H. 2392 mm. Spiegel GXDR01, Lasermat GXDR02.  
/ Estructura fitness que se puede equipar. Espaldera de pared: panel frontal en acabado espejo o Lasermat, estructura de aluminio, 2 barras frontal deslizantes (con bloqueo) de acero revestido de madera pintada negro mate. L. 914, P. 340, H. 2392 mm. Espejo GXDR01, Lasermat GXDR02.

**Origine**

/ Panca in legno composta da listelli di legno massello verniciato nero opaco. L. 1400, P. 344, H. 85 mm. GXDS01.  
/ Wooden bench made of matt black painted wood slats. L. 1400, P. 344, H. 85 mm. GXDS01.  
/ Banc en bois. Lattes de bois massif peint noir mat. L. 1400, P. 344, H. 85 mm. GXDS01.  
/ Bank aus Holz, bestehend aus Leisten aus matt schwarz lackiertem Holz. L. 1400, P. 344, H. 85 mm. GXDS01.  
/ Banco de madera. Listones de madera maciza pintada negro mate. L. 1400, P. 344, H. 85 mm. GXDS01.

**Origine**

/ Set elastici neri, maniglie in legno verniciato nero opaco. GXDT01.  
/ Set of black rubber bands, grips in matt black painted wood. GXDT01.  
/ Set d'élastiques noirs, poignées en bois peint noir mat. GXDT01.  
/ Satz schwarze elastische Gurten, Griffe aus matt schwarz lackiertem Holz. GXDT01.  
/ Juego gomas elásticas negras, asas de madera pintada negro mate. GXDT01.

## Complementi, Specchi, Lampade Complementary Items, Mirrors, Lamps

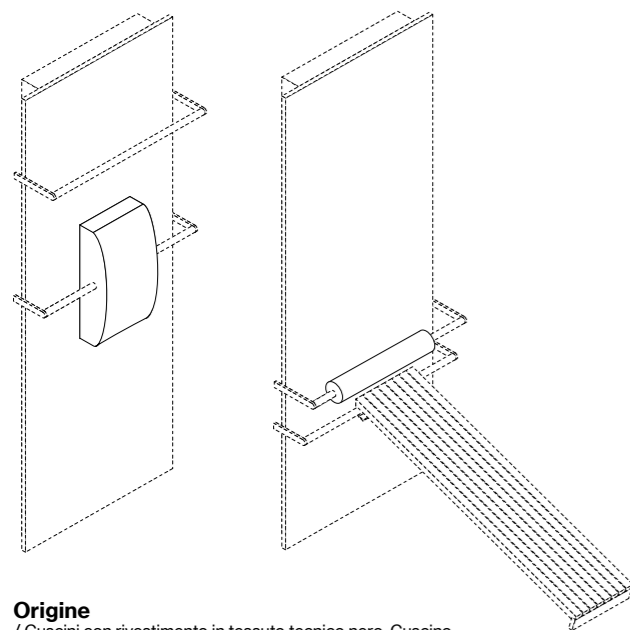

### Origine

/ Cuscini con rivestimento in tessuto tecnico nero. Cuscino convesso grande L. 600 P. 300 H. 167, GXDU01. Cuscino cilindrico piccolo L. 500 P. 100 H. 100, GXDU02.

/ Pillows in black heavy-duty material. Big curved pillow L. 600 P. 300 H. 167, GXDU01. Small cylindrical pillow L. 500 P. 100 H. 100, GXDU02.

/ Coussins avec revêtement en tissu technique noir. Grand coussin convexe L. 600 P. 300 H. 167, GXDU01. Petit coussin cylindrique L. 500 P. 100 H. 100, GXDU02.

/ Kissen mit Bezug aus schwarzem technischem Gewebe. Großem konvex geformtem Kissen L. 600 P. 300 H. 167, GXDU01. Kleinem zylindrisch geformtem Kissen L. 500 P. 100 H. 100, GXDU02.

/ Cojines con recubrimiento de tejido técnico negro. Cojín convexo grande L. 600 P. 300 H. 167, GXDU01. Cojín cilíndrico pequeño L. 500 P. 100 H. 100, GXDU02.

### \* Treves

/ Programma di contenitori pensile disponibili nella versione a giorno, con anta chiusa o con anta telaio + specchio. Apertura a pressione. / Open-faced wall units, with door or frame door + mirror. Push opening. / Programme d'éléments haut disponibles dans la version ouverte, avec porte fermée ou avec porte cadre + miroir. Ouverture automatique par pression. / Das Hängeschrank-Programm. ist in der offenen Version, mit normalen Türen oder mit Rahmentür + Spiegel erhältlich. Automatisches Druck-Öffnungssystem. / Programa de muebles contenedores altos disponibles en la versión abierta, con puerta cerrada o con puerta marco + espejo. Apertura automática asistida.

/

\* Disponibile fino ad esaurimento scorte  
Available until stock lasts

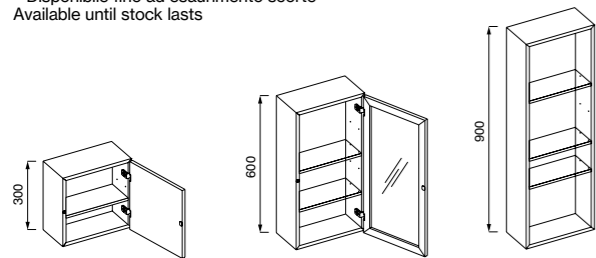

### Treves

/ Contenitori in pannelli di particelle di legno, spessore 14 mm. Finitura: esterno e bordo frontale bianco opaco, interno e ripiani larice termico graffiato. Ante chiuse: pannello ligneo ultraleggero spessore 14 mm. con apertura a pressione. Finitura Silcover. Ante telaio: in alluminio spessore 14 mm. con vetro a specchio. Apertura a pressione. Finitura alluminio anodizzato nero.

/ Units produced with 14 mm. thick wood particle boards. Finish: external part and frontal trim in matt white, internal part and shelves in thermo-treated larch wood, textured finish. Closed doors made of 14 mm. thick woody ultra light panel, with "tip-on" push-opening. Finish: Silcover. Frame doors: in aluminium, th. 14 mm, with mirrored glass. "tip-on" push-opening. Finish: black anodised aluminium.

/ Éléments en panneaux de particules de bois épaisseur 14 mm. Finition : extérieur et chant façade blanc mat, intérieur et étagères mélèze thermique rugueux. Portes fermées : panneau en bois ultraléger épaisseur 14 mm. avec ouverture par pression. Finition : Silcover. Portes cadre : en aluminium épaisseur 14 mm. avec verre miroir. Ouverture par pression. Finition : aluminium anodisé noir.

/ Schrankelemente in Holzspanplatten, St. 14 mm. Ausführung: Außen und Frontkante mattweiß lackiert, innen und Fachböden Thermoholz Lärche, rau. Normale Tür: sehr leichtes Holz-paneel, St. 14 mm, mit Druck-Öffnung. Ausführung: Silcover Rahmentür: aus Aluminium, St. 14 mm, mit Spiegelglas. Druck-Öffnung. Ausführung: Aluminium eloxiert, schwarz.

/ Muebles contenedores de paneles de particulas de madera de 14 mm. Acabados: exterior y borde frontal blanco mate, interior y baldas alerce termico rayado. Puertas cerradas: panel de madera ultraligero de 14 mm. de espesor, con apertura automática asistida "tip-on". Acabados: Silcover. Puertas marco de aluminio de 14 mm. de espesor con vidrio de espejo. Apertura automática asistida "tip-on". Acabados: aluminio anodizado negro.

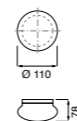

### Boccia

/ Lampada da parete. Diffusore: vetro opalino. Supporto: alluminio verniciato bianco. Illuminazione: alogena G9 max 40 W - LED Acrich 2 dimmerabile 12 W. Illuminazione alogena: alimentazione 220 ÷ 230 V, 50 Hz - EU GMOC01; 110 ÷ 125 V, 60 Hz - U.S.A. GMOC02. Illuminazione a LED: alimentazione 220 ÷ 230 V, 50 Hz - EU GMOC03; 110 ÷ 125 V, 60 Hz - U.S.A. GMOC04.

/ Wall lamp. Diffuser: opal glass. Support: aluminium, white-painted. Lighting: G9 halogen, max 40 W - LED Acrich 2, dimmable, 12 W. Halogen lighting: voltage 220 ÷ 230 V, 50 Hz - EU GMOC01; 110 ÷ 125 V, 60 Hz - U.S.A. GMOC02. LED lighting: voltage 220 ÷ 230 V, 50 Hz - EU GMOC03; 110 ÷ 125 V, 60 Hz - U.S.A. GMOC04.

/ Lampe murale. Diffuseur : verre opalin. Support : aluminium peint blanc. Eclairage : halogène G9 max 40 W - LED Acrich 2 gradable 12 W. Eclairage halogène : alimentation 220 ÷ 230 V, 50 Hz - EU GMOC01; 110 ÷ 125 V, 60 Hz - U.S.A. GMOC02. Eclairage LED: alimentation 220 ÷ 230 V, 50 Hz - EU GMOC03; 110 ÷ 125 V, 60 Hz - U.S.A. GMOC04.

/ Wandleuchte. Lampe: Opalglas. Träger: weiß lackiertes Aluminium. Leuchtmittel: Halogen G9 max. 40 W - LED Acrich 2 dimmbar 12 W Halogen-Leuchtmittel: Spannung 220 ÷ 230 V, 50 Hz - EU GMOC01; 110 ÷ 125 V, 60 Hz - U.S.A. GMOC02. LED-Leuchtmittel: Spannung 220 ÷ 230 V, 50 Hz - EU GMOC03; 110 ÷ 125 V, 60 Hz - U.S.A. GMOC04.

/ Lámpara de pared. Difusor: cristal opalina. Soporte: aluminio pintado blanco. Iluminación: halógena G9 máx 40 W - LED Acrich 2 dimmable 12 W Iluminación halógena: alimentación 220 ÷ 230 V, 50 Hz - EU GMOC01; 110 ÷ 125 V, 60 Hz - U.S.A. GMOC02. Iluminación LED: alimentación 220 ÷ 230 V, 50 Hz - EU GMOC03; 110 ÷ 125 V, 60 Hz - U.S.A. GMOC04.

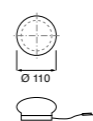

### Boccia

/ Lampada da appoggio. Diffusore: vetro opalino. Supporto: alluminio verniciato bianco. Illuminazione: alogena G9 max 28 W - LED Acrich 2 dimmerabile 12 W. Accensione intergata su cavo, spina 10° (Italia). Illuminazione alogena: alimentazione 220 ÷ 230 V, 50 Hz - EU GMOC05; 110 ÷ 125 V, 60 Hz - U.S.A. GMOC06. Illuminazione a LED: alimentazione 220 ÷ 230 V, 50 Hz - EU GMOC07; 110 ÷ 125 V, 60 Hz - U.S.A. GMOC08.

/ Top-mounted lamp. Diffuser: opal glass. Support: aluminium, white-painted. Lighting: G9 halogen, max 28 W - LED Acrich 2, dimmable, 12 W. Light switch integrated on cable, plug: 10 A (Italy). Halogen lighting: voltage 220 ÷ 230 V, 50 Hz - EU GMOC05; 110 ÷ 125 V, 60 Hz - U.S.A. GMOC06. LED lighting: voltage 220 ÷ 230 V, 50 Hz - EU GMOC07; 110 ÷ 125 V, 60 Hz - U.S.A. GMOC08.

/ Lampe d'appui. Diffuseur : verre opalin. Support : aluminium peint blanc. Eclairage : halogène G9 max 28 W - LED Acrich 2 gradable 12 W. Allumage: intégré sur cable, fiche : 10 A (Italie). Eclairage halogène : alimentation 220 ÷ 230 V, 50 Hz - EU GMOC05; 110 ÷ 125 V, 60 Hz - U.S.A. GMOC06. Eclairage LED: alimentation 220 ÷ 230 V, 50 Hz - EU GMOC07; 110 ÷ 125 V, 60 Hz - U.S.A. GMOC08.

/ Tischleuchte. Lampe: Opalglas. Träger: weiß lackiertes Aluminium. Leuchtmittel: Halogen G9 max. 28 W - LED Acrich 2 dimmbar 12 W. Lampenschaltung: im Kabel integriert, Stecker: 10 A (Italien). Halogen-Leuchtmittel: Spannung 220 ÷ 230 V, 50 Hz - EU GMOC05; 110 ÷ 125 V, 60 Hz - U.S.A. GMOC06. LED-Leuchtmittel: Spannung 220 ÷ 230 V, 50 Hz - EU GMOC07; 110 ÷ 125 V, 60 Hz - U.S.A. GMOC08.

/ Lámpara de apoyo. Difusor: cristal opalina. Soporte: aluminio pintado blanco. Iluminación: halógena G9 máx 28 W - LED Acrich 2 dimmable 12 W. Encendido: integrado en el cable, clavija: 10 A (Italia). Iluminación halógena: alimentación 220 ÷ 230 V, 50 Hz - EU GMOC05; 110 ÷ 125 V, 60 Hz - U.S.A. GMOC06. Iluminación LED: alimentación 220 ÷ 230 V, 50 Hz - EU GMOC07; 110 ÷ 125 V, 60 Hz - U.S.A. GMOC08.

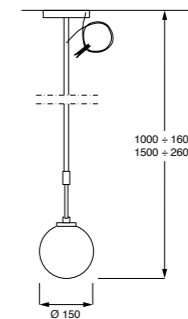

### Boccia

/ Lampada a sospensione. Diffusore: vetro opalino. Asta: alluminio anodizzato nero opaco con regolazione in altezza telescopica manuale (min. 1000 mm, max 2600 mm). Illuminazione alogena: G9 max 60 W. H. 1000/1600 mm: alimentazione 220 ÷ 230 V, 50 Hz - EU, GMOC09; 110 ÷ 125 V, 60 Hz - U.S.A. GMOC10. H. 1500/2600 mm: alimentazione 220 ÷ 230 V, 50 Hz - EU, GMOC11; 110 ÷ 125 V, 60 Hz - U.S.A. GMOC12.

/ Suspended lamp. Diffuser: opal glass. Rod: in matt black anodised aluminium, with manual telescopic height adjustment (min. 1000 mm, max 2600 mm). Lighting: G9 halogen, max 60 W. H. 1000/1600 mm: voltage 220 ÷ 230 V, 50 Hz - EU, GMOC09; 110 ÷ 125 V, 60 Hz - U.S.A. GMOC10. H. 1500/2600 mm: voltage 220 ÷ 230 V, 50 Hz - EU, GMOC11; 110 ÷ 125 V, 60 Hz - U.S.A. GMOC12.

/ Lampe à suspension. Diffuseur: verre opalin. Tige : aluminium anodisé noir mat avec réglage en hauteur télescopique manuelle (min. 1000 mm, max 2600 mm). Eclairage : halogène G9 max 60 W. H. 1000/1600 mm: alimentation 220 ÷ 230 V, 50 Hz - EU, GMOC09; 110 ÷ 125 V, 60 Hz - U.S.A. GMOC10. H. 1500/2600 mm: alimentation 220 ÷ 230 V, 50 Hz - EU, GMOC11; 110 ÷ 125 V, 60 Hz - U.S.A. GMOC12.

/ Hängeleuchte. Lampe: Opalglas. Stange: eloxiertes Aluminium matt schwarz, mit manueller teleskopischer Höhenverstellung (mind. 1000 mm, max. 2600 mm). Leuchtmittel: Halogen G9 max. 60 W. H. 1000/1600 mm: Spannung 220 ÷ 230 V, 50 Hz - EU, GMOC09; 110 ÷ 125 V, 60 Hz - U.S.A. GMOC10. H. 1500/2600 mm: Spannung 220 ÷ 230 V, 50 Hz - EU, GMOC11; 110 ÷ 125 V, 60 Hz - U.S.A. GMOC12.

/ Lámpara de suspensión. Difusor: cristal opalina. Barra: aluminio anodizado negro mate con regulación en altura telescópica manual (min. 1000 mm, max 2600 mm). Iluminación: halógena G9 max 60 W. H. 1000/1600 mm: alimentación 220 ÷ 230 V, 50 Hz - EU, GMOC09; 110 ÷ 125 V, 60 Hz - U.S.A. GMOC10. H. 1500/2600 mm: alimentación 220 ÷ 230 V, 50 Hz - EU, GMOC11; 110 ÷ 125 V, 60 Hz - U.S.A. GMOC12.

## Complementi, Specchi, Lampade Complementary Items, Mirrors, Lamps

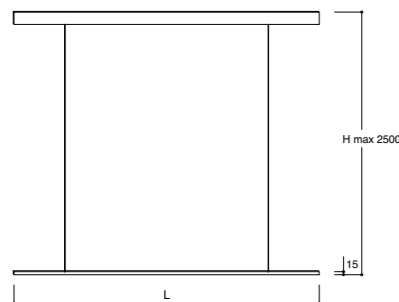

### Giò

/ Lampada a sospensione con controllo a sfioramento. Struttura: profilo di alluminio, con schermo protettivo in polycarbonato. Finiture: verniciato nero e verniciato bianco. Cavi per sospensione in acciaio max H. 2500 mm. Illuminazione LED. Assorbimento 20 W per metro lineare. L. 1000 mm, nero GMJO01, bianco GMJO04. L. 1500 mm, nero GMJO02, bianco GMJO05. L. 2000 mm, nero GMJO03, bianco GMJO06. / Lampada a sospensione per controllo remoto. Struttura: profilo di alluminio, con schermo protettivo in polycarbonato. Finiture: verniciato nero e verniciato bianco. Cavi per sospensione in acciaio max H. 2500 mm. Illuminazione LED. Assorbimento 20 W per metro lineare. L. 1000 mm, nero GMJO11, bianco GMJO14. L. 1500 mm, nero GMJO12, bianco GMJO15. L. 2000 mm, nero GMJO13, bianco GMJO16. / Suspended lamp with touch control. Structure: aluminium profile, with protective screen in polycarbonate. Finishes: black painted - white painted. Stainless steel cables max H. 2500 mm. Lighting: LED. Absorption: 20 W per linear metre. L. 1000 mm, black GMJO01, white GMJO04. L. 1500 mm, black GMJO02, white GMJO05. L. 2000 mm, black GMJO03, white GMJO06. / Suspended lamp for remote control. Structure: aluminium profile, with protective screen in polycarbonate. Finishes: black painted - white painted. Stainless steel cables max H. 2500 mm. Lighting: LED. Absorption: 20 W per linear metre. L. 1000 mm, black GMJO11, white GMJO14. L. 1500 mm, black GMJO12, white GMJO15. L. 2000 mm, black GMJO13, white GMJO16.

/ Lampe à suspension avec contrôle par effleurement. Structure: profil d'aluminium, avec écran de protection en polycarbonate. Finitions: peint noir - peint blanc. Câbles pour suspension en acier max H. 2500 mm. Eclairage: LED. Absorption: 20 W au mètre linéaire. L. 1000 mm, noir GMJO01, blanc GMJO04. L. 1500 mm, noir GMJO02, blanc GMJO05. L. 2000 mm, noir GMJO03, blanc GMJO06. / Lampe à suspension pour contrôle déporté. Structure: profil d'aluminium, avec écran de protection en polycarbonate. Finitions: peint noir - peint blanc. Câbles pour suspension en acier max H. 2500 mm. Eclairage: LED. Absorption: 20 W au mètre linéaire. L. 1000 mm, noir GMJO11, blanc GMJO14. L. 1500 mm, noir GMJO12, blanc GMJO15. L. 2000 mm, noir GMJO13, blanc GMJO16.

/ Hängelampe mit Touch-Schaltung. Struktur: Profil aus Aluminium, mit Lampenschirm aus Polycarbonat Ausführung: lackiert schwarz - lackiert weiß. Pendelkabel aus Stahl max H. 2500 mm. Beleuchtung: LED. Leistung: 20 W je lfd. Meter. L. 1000 mm, schwarz GMJO01, weiß GMJO04. L. 1500 mm, schwarz GMJO02, weiß GMJO05. L. 2000 mm, schwarz GMJO03, weiß GMJO06. / Hängelampe für Fernschaltung. Struktur: Profil aus Aluminium, mit Lampenschirm aus Polycarbonat. Ausführungen: lackiert schwarz - lackiert weiß. Pendelkabel aus Stahl max H. 2500 mm. Beleuchtung: LED. Leistung: 20 W je lfd. Meter. L. 1000 mm, schwarz GMJO11, weiß GMJO14. L. 1500 mm, schwarz GMJO12, weiß GMJO15. L. 2000 mm, schwarz GMJO13, weiß GMJO16. / Lámpara de suspensión con control de roce. Estructura: perfil de aluminio, con pantalla de protección de polycarbonato. Acabados: pintado negro - pintado blanco. Cables para suspensión de acero máx H. 2500 mm. Iluminación: LED. Absorción: 20 W por metro lineal. L. 1000 mm, negro GMJO01, blanco GMJO04. L. 1500 mm, negro GMJO02, blanco GMJO05. L. 2000 mm, negro GMJO03, blanco GMJO06. / Lámpara de suspensión para control a distancia. Estructura: perfil de aluminio, con pantalla de protección de polycarbonato. Acabados: pintado negro - pintado blanco. Cables para suspensión de acero máx H. 2500 mm. Iluminación: LED. Absorción: 20 W por metro lineal. L. 1000 mm, negro GMJO11, blanco GMJO14. L. 1500 mm, negro GMJO12, blanco GMJO15. L. 2000 mm, negro GMJO13, blanco GMJO16.

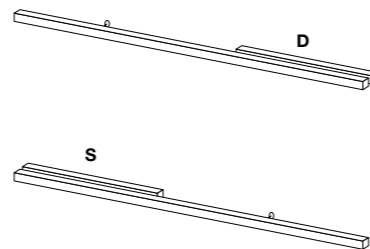

### Giò Wall

/ Lampada a parete. Struttura: profilo di alluminio, con schermo protettivo in polycarbonato. Finiture: verniciato nero - verniciato bianco. Illuminazione: LED. Assorbimento: 20 W per metro lineare. L. 600 mm, nero GMJO31 S-D, bianco GMJO41 S-D. L. 900 mm, nero GMJO32 S-D, bianco GMJO42 S-D. L. 1000 mm, nero GMJO33 S-D, bianco GMJO43 S-D. L. 1200 mm, nero GMJO34 S-D, bianco GMJO44 S-D. L. 1500 mm, nero GMJO35 S-D, bianco GMJO45 S-D. L. 1800 mm, nero GMJO36 S-D, bianco GMJO46 S-D. L. 2000 mm, nero GMJO37 S-D, bianco GMJO47 S-D.

/ Wall lamp. Structure: aluminium profile, with protective screen in polycarbonate. Finishes: black painted - white painted. Lighting: LED. Absorption: 20 W per linear metre. L. 600 mm, black GMJO31 S-D, white GMJO41 S-D. L. 900 mm, black GMJO32 S-D, white GMJO42 S-D. L. 1000 mm, black GMJO33 S-D, white GMJO43 S-D. L. 1200 mm, black GMJO34 S-D, white GMJO44 S-D. L. 1500 mm, black GMJO35 S-D, white GMJO45 S-D. L. 1800 mm, black GMJO36 S-D, white GMJO46 S-D. L. 2000 mm, black GMJO37 S-D, white GMJO47 S-D. / Lampe murale. Structure: profil d'aluminium, avec écran de protection en polycarbonate. Finitions: peint noir - peint blanc. Eclairage: LED. Absorption: 20 W au mètre linéaire. L. 600 mm, noir GMJO31 S-D, blanc GMJO41 S-D. L. 900 mm, noir GMJO32 S-D, blanc GMJO42 S-D. L. 1000 mm, noir GMJO33 S-D, blanc GMJO43 S-D. L. 1200 mm, noir GMJO34 S-D, blanc GMJO44 S-D. L. 1500 mm, noir GMJO35 S-D, blanc GMJO45 S-D. L. 1800 mm, noir GMJO36 S-D, blanc GMJO46 S-D. L. 2000 mm, noir GMJO37 S-D, blanc GMJO47 S-D.

/ Wandleuchte. Struktur: Profil aus Aluminium, mit Lampenschirm aus Polycarbonat. Ausführungen: lackiert schwarz - lackiert weiß. Beleuchtung: LED. Leistung: 20 W je lfd. Meter. L. 600 mm, schwarz GMJO31 S-D, weiß GMJO41 S-D. L. 900 mm, schwarz GMJO32 S-D, weiß GMJO42 S-D. L. 1000 mm, schwarz GMJO33 S-D, weiß GMJO43 S-D. L. 1200 mm, schwarz GMJO34 S-D, weiß GMJO44 S-D. L. 1500 mm, schwarz GMJO35 S-D, weiß GMJO45 S-D. L. 1800 mm, schwarz GMJO36 S-D, weiß GMJO46 S-D. L. 2000 mm, schwarz GMJO37 S-D, weiß GMJO47 S-D. / Lámpara de pared. Estructura: perfil de aluminio, con pantalla de protección de polycarbonato. Acabados: pintado negro - pintado blanco. Iluminación: LED. Absorción: 20 W por metro lineal. L. 600 mm, negro GMJO31 S-D, blanco GMJO41 S-D. L. 900 mm, negro GMJO32 S-D, blanco GMJO42 S-D. L. 1000 mm, negro GMJO33 S-D, blanco GMJO43 S-D. L. 1200 mm, negro GMJO34 S-D, blanco GMJO44 S-D. L. 1500 mm, negro GMJO35 S-D, blanco GMJO45 S-D. L. 1800 mm, negro GMJO36 S-D, blanco GMJO46 S-D. L. 2000 mm, negro GMJO37 S-D, blanco GMJO47 S-D.

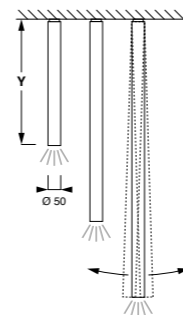

### L.o.p. Colours

/ Lampada oscillante a sospensione. Finiture: verniciato bianco opaco / verniciato nero opaco / anodizzato inox. Struttura: alluminio. Illuminazione: LED GU10 max 7 W. Alimentazione: 220 ÷ 230 V, 50 Hz - EU: altezza Y da 500 a 1000 mm. GMOP04, Y da 1001 a 2000 mm. GMOP05; Y da 2001 a 3000 mm. GMOP06. Alimentazione: 110 ÷ 120 V, 60 Hz - U.S.A.: altezza Y da 500 a 1000 mm. GMOP07, Y da 1001 a 2000 mm. GMOP08, Y da 2001 a 3000 mm. GMOP09. / Suspended swinging lamp. Finishes: matt white varnished / matt black varnished / anodised stainless steel. Structure: aluminium. Lighting: LED GU10 max 7 W. Voltage: 220 ÷ 230 V, 50 Hz - EU: height Y from 500 to 1000 mm. GMOP04, Y from 1001 to 2000 mm. GMOP05; Y from 2001 to 3000 mm. GMOP06. Voltage: 110 ÷ 120 V, 60 Hz - U.S.A.: height Y from 500 to 1000 mm. GMOP07, Y from 1001 to 2000 mm. GMOP08, Y from 2001 to 3000 mm. GMOP09.

/ Lampe oscillante à suspension. Finitions : peint blanc mat / peint noir mat / anodisé inox. Structure: aluminium. Eclairage : LED GU10 max 7 W Alimentation: 220 ÷ 230 V, 50 Hz - EU: hauteur Y de 500 à 1000 mm. GMOP04, Y de 1001 à 2000 mm. GMOP05; Y de 2001 à 3000 mm. GMOP06. Alimentation: 110 ÷ 120 V, 60 Hz - U.S.A.: hauteur Y de 500 à 1000 mm. GMOP07, Y de 1001 à 2000 mm. GMOP08, Y de 2001 à 3000 mm. GMOP09. / Pendelleuchte. Ausführungen: matt weiß lackiert / matt schwarz lackiert / eloxierter Edelstahl. Gehäuse: Aluminium. Leuchtmittel: LED GU10 max. 7 W. Spannung: 220 ÷ 230 V, 50 Hz - EU: Höhe Y von 500 bis 1000 mm. GMOP04, Y von 1001 bis 2000 mm. GMOP05; Y von 2001 bis 3000 mm. GMOP06. Spannung: 110 ÷ 120 V, 60 Hz - U.S.A.: Höhe Y von 500 bis 1000 mm. GMOP07, Y von 1001 bis 2000 mm. GMOP08, Y von 2001 bis 3000 mm. GMOP09.

/ Lámpara oscilante de suspensión. Acabados: pintado blanco mate / pintado negro mate / anodizado inox. Estructura: aluminio. Iluminación: LED GU10 máx 7 W. Alimentación: 220 ÷ 230 V, 50 Hz - EU: altura Y de 500 a 1000 mm. GMOP04, Y de 1001 a 2000 mm. GMOP05; Y de 2001 a 3000 mm. GMOP06. Alimentación: 110 ÷ 120 V, 60 Hz - U.S.A.: altura Y de 500 a 1000 mm. GMOP07, Y de 1001 a 2000 mm. GMOP08, Y de 2001 a 3000 mm. GMOP09.

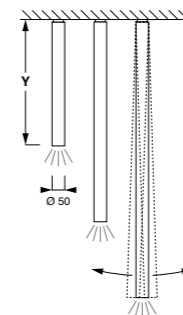

### L.o.p.

/ Lampada oscillante a sospensione. Struttura: alluminio anodizzato finitura inox. Illuminazione: a LED. Potenza massima: 10W. Alimentazione: 220 ÷ 230 V, 50 Hz - EU / 110 ÷ 120 V, 60 Hz - U.S.A.: altezza Y da 500 a 1000 mm. GMOP01, Y da 1001 a 2000 mm. GMOP02; Y da 2001 a 3000 mm. GMOP03. / Suspended swinging lamp. Structure: anodised aluminium, stainless steel finish. Lighting: LED. Max. power: 10 W. Voltage: 220 ÷ 230 V, 50 Hz - EU / 110 ÷ 120 V, 60 Hz - U.S.A.: height Y from 500 to 1000 mm. GMOP01, Y from 1001 to 2000 mm. GMOP02; Y from 2001 to 3000 mm. GMOP03.

/ Lampe oscillante à suspension. Structure: aluminium anodisé finition inox. Eclairage: à LED. Puissance maximum: 10 W. Alimentation: 220 ÷ 230 V, 50 Hz - EU / 110 ÷ 120 V, 60 Hz - U.S.A.: hauteur Y de 500 à 1000 mm. GMOP01, Y de 1001 à 2000 mm. GMOP02; Y de 2001 à 3000 mm. GMOP03. / Pendelleuchte. Gehäuse: eloxiertes Aluminium, Ausführung Edelstahl. Leuchtmittel: LED max. Leistung: 10 W. Spannung: 220 ÷ 230 V, 50 Hz - EU: Höhe Y von 500 bis 1000 mm. GMOP01, Y von 1001 bis 2000 mm. GMOP02; Y von 2001 bis 3000 mm. GMOP03. / Lámpara oscilante de suspensión. Estructura: aluminio anodizado acabado inox. Iluminación: LED. Potencia máxima: 10 W. Alimentación: 220 ÷ 230 V, 50 Hz - EU / 110 ÷ 120 V, 60 Hz - U.S.A.: altura Y de 500 a 1000 mm. GMOP01, Y de 1001 a 2000 mm. GMOP02; Y de 2001 a 3000 mm. GMOP03.

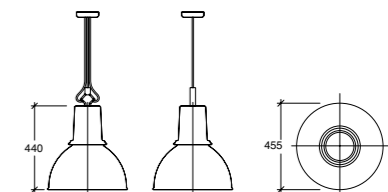

### Naviglio

/ Lampada Naviglio per luce ad incandescenza, in alluminio tornito in lastra. Lampada utilizzabile max. 200 W. - Tensione 220 V, 50 Hz. - Lunghezza cavi 2500 mm. In alluminio GMNV01, verniciata panna GMNV02, verniciata nera GMNV03. Per mercato USA - Tensione 110 V, 60 Hz. Lunghezza cavi 2500 mm. Certificato UL. In alluminio GMNV04, verniciata panna GMNV05, verniciata nera GMNV06.

/ Naviglio lamp for incandescent light, in sheet-turned aluminium. Bulb max. 200 W. - Voltage 220 V, 50 Hz. - Cables length: 2500 mm. In aluminium GMNV01, cream lacquered GMNV02, black lacquered GMNV03. For US market - Voltage 110 V, 60 Hz. Naviglio lamp for incandescent light, in sheet-turned aluminium. Cables length: 2500 mm. - UL-certified. In aluminium GMNV04, cream lacquered GMNV05, black lacquered GMNV06.

/ Lampes Naviglio, ampoule à incandescente, en aluminium tourné en plaque. Lampe utilisable max. 200 W. - Tension 220 V, 50 Hz. - Longueur câbles 2500 mm. In aluminium GMNV01, vernis crème GMNV02, vernis noir GMNV03. Pour marché USA - Tension 110 V, 60 Hz. Longueur câbles 2500 mm. - Certificat UL, in aluminium GMNV04, vernis crème GMNV05, vernis noir GMNV06.

/ Aluminiumleuchte Naviglio blechgedreht, mit Glühluchte. Verwendbare Leuchte max 200 W. - Anschluß 220 V, 50 Hz. - Kabellänge: 2500 mm. Aluminium GMNV01, cremeweiß GMNV02, schwarz GMNV03, Für Amerik. Markt - Anschluß 110 V, 60 Hz. - Kabellänge: 2500 mm. - UL-Zertifikat. Aluminium GMNV04, cremeweiß GMNV05, Schwarz GMNV06.

/ Lámpara Naviglio para luz de incandescencia, en aluminio torneado en capa. Lámpara utilizable máx. 200 W. Tensión 220 V, 50 Hz. Longitud cables 2500 mm. Estética aluminio GMNV01. Estética barnizada nata GMNV02. Estética barnizada negra GMNV03. PARA MERCADO USA - Tensión 110 V, 60 Hz. Longitud cables 2500 mm. Estética aluminio GMNV04. Estética barnizada nata GMNV05. Estética barnizada da negra GMNV06.

## Complementi, Specchi, Lampade Complementary Items, Mirrors, Lamps

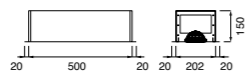
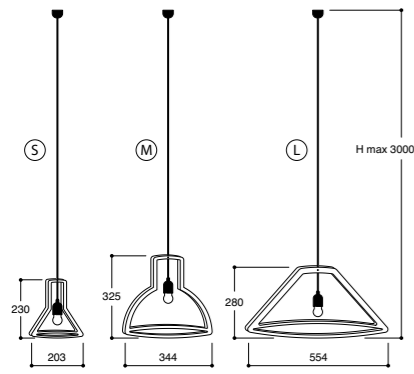

### Outliner

/ Lampada a sospensione. Struttura in agglomerato ligneo nero ad alta densità con rivestimento esterno in carta melaminica bianca. H max 3000 mm (compreso corpo lampada). Cavo per sospensione e alimentazione rivestito con tessuto intrecciato colore rosso. Rosone a soffitto colore nero. Small, L. 203 mm, versione Europa GMOL01, versione USA GMOL04. Medium, L. 344 mm, versione Europa GMOL02, versione USA GMOL05. Large, L. 554 mm, versione Europa GMOL03, versione USA GMOL06.  
/ Suspended lamp. Structure in black fibres board, high density coated with white melamine paper. H max 3000 mm (lamp body included). Feeding cable covered by red woven fabric. Black roundel part, ceiling-fixed. Small, L. 203 mm, Europe version GMOL01, USA version GMOL04. Medium, L. 344 mm, Europe version GMOL02, USA version GMOL05. Large, L. 554 mm, Europe version GMOL03, USA version GMOL06.

/ Lampe à suspension. Structure: aggloméré de bois noir à haute densité avec revêtement externe en papier mélaminique blanc. H max 3000 mm (compris corps lampe). Câble pour suspension et alimentation revêtu avec tissu tressé couleur rouge. Rosace au plafond couleur noire. Small, L. 203 mm, version Europe GMOL01, version USA GMOL04. Medium, L. 344 mm, version Europe GMOL02, version USA GMOL05. Large, L. 554 mm, version Europe GMOL03, version USA GMOL06.

/ Hängelampe. Struktur aus hochdichter Spanholzplatte schwarz, außen mit Melaminharzbeschichtung weiß. H max 3000 mm (einschließlich Lampenkörper). Pendel- und Stromkabel, mit rotem Gewebe ummantelt. Deckenrossette schwarz. Small, L. 203 mm, Version Europa GMOL01, Version USA GMOL04. Medium, L. 344 mm, Version Europa GMOL02, Version USA GMOL05. Large, L. 554 mm, Version Europa GMOL03, Version USA GMOL06.

/ Lámpara de suspensión. Estructura: madera conglomerada negra de alta densidad con revestimiento exterior de papel de melamina blanca. H máx 3000 mm (incluido cuerpo lámpara). Cable para suspensión y alimentación revestido con tela entrelazada color rojo. Rosetón de techo color negro. Small, L. 203 mm, versión Europa GMOL01, versión EE.UU GMOL04. Medium, L. 344 mm, versión Europa GMOL02, versión EE.UU GMOL05. Large, L. 554 mm, versión Europa GMOL03, versión EE.UU GMOL06.

### T18

/ Sistema di illuminazione modulare ad elementi elettrificati a bassa tensione 12 V, componibili con moduli L. 1200 mm. Nel canale porta fari, in metallo verniciato bianco o nero, o in lamiera grezza non trattata, è possibile l'alloggiamento di fari fissati magneticamente, e orientabili in un massimo di 4 fari (3 fari per versione USA) per modulo L. 1200 mm. e 1 fero per modulo L. 500 mm. I fari sono di 2 tipologie: con luce concentrata (con cono di luce di 24°), o con luce diffusa (cono di luce di 45°). Versione da incasso a filo soffitto. Modulo elettrificato da incasso porta fari, con 2 tappi di chiusura. L. 500 mm. GMTU06 / Tensione 110 V, 60 Hz, GMTU15. Modulo elettrificato da incasso porta fari, con 2 tappi di chiusura. L. 1200 mm. GMTU07 / Tensione 110 V, 60 Hz, GMTU16. Modulo elettrificato da incasso porta fari, terminale, con 1 tappo di chiusura. L. 1200 mm. GMTU08 / Tensione 110 V, 60 Hz, GMTU17. Modulo elettrificato da incasso porta fari, centrale. L. 1200 mm. GMTU09 / Tensione 110 V, 60 Hz, GMTU18.

/ Modular lighting system, composed by electrified elements with low consumption (12 V) and modules 1200 mm. long. In the tube, in white or black-lacquered metal or in not-treated raw plate, adjustable spotlights, equipped with magnetic support, can be fixed. Max. 4 spotlights (3 spotlights for US version) can be positioned in a 1200 mm. module and 1 spotlight in a 500 mm. module. The spotlights can have a concentrated light (with 24° light cone), or a diffused light (with 45° light cone). Recessed version. Built-in electrified module for spotlights, with 2 terminals W. 500 mm. GMTU06 / Voltage 110 V, 60 Hz, GMTU15. Built-in electrified module for spotlights, with 2 terminals W. 1200 mm. GMTU07 / Voltage 110 V, 60 Hz, GMTU16. Built-in terminal-electrified module for spotlights, with 1 terminal left or right W. 1200 mm. GMTU08 / Voltage 110 V, 60 Hz, GMTU17. Built-in central- electrified module for spotlights W. 1200 mm. GMTU09 / Voltage 110 V, 60 Hz, GMTU18.

/ Systèmes d'éclairage modulaires à éléments électrifiés à basse tension 12 V, à composer avec modules de L. 1200 mm. dans le rail porte-spots, en métal peint blanc ou noir, ou en tôle brute non traitée, le logement de spots fixés magnétiquement, et orientables est possible pour un maximum de 4 spots (3 spots pour marché USA) pour module L. 1200 mm. et 1 spot pour module L. 500 mm. Ils sont de deux typologies: avec lumière concentrée (avec cône de lumière de 24°), ou avec lumière diffuse (cône de lumière de 45°). Version encastrable affleurant plafond. Module électrifié encastrable porte-spots, avec 2 bouchons de fermeture L. 500 mm. GMTU06 / Alimentation 110 V, 60 Hz, GMTU15. Module électrifié encastrable porte-spots, avec 2 bouchons de fermeture L. 1200 mm. GMTU07 / Alimentation 110 V, 60 Hz, GMTU16. Module électrifié encastrable porte-spots, d'extrémité, avec 1 bouchon de fermeture L. 1200 mm. GMTU08 / Alimentation 110 V, 60 Hz, GMTU17. Module électrifié encastrable porte-spots, central, L. 1200 mm. GMTU09 / Alimentation 110 V, 60 Hz, GMTU18.

/ Modulares Niedervolt-Beleuchtungssystem, (12 V), mit Modulen B. 1200 mm. In der Lichtleiste aus weiß oder schwarz lackiertem oder unbehandeltem Metall finden je Modul B. 1200 mm. max. 4 (3 für amerik. Markt) und je Modul B. 500 mm. max. 1 bewegliche und mittels Magnet befestigte Spots ihren Sitz. Mit 2 Lichttypologien: Konzentriertes Licht (Lichtkegel 24°) oder Streulicht (Lichtkegel 45°). Einbau-Version. Einbau-Lichtleiste für Spots, mit 2 Verschlusskappen B. 500 mm. GMTU06 / Spannung 110 V, 60 Hz, GMTU15. Einbau-Lichtleiste für Spots, mit 2 Verschlusskappen B. 1200 mm. GMTU07 / Spannung 110 V, 60 Hz, GMTU16. Abschluss-Einbau-Lichtleiste für Spots, mit 1 Verschlusskappe B.1200 mm. GMTU08 / Spannung 110 V, 60 Hz, GMTU17. Einbau-Lichtleiste für Spots, mittig B. 1200 mm. GMTU09 Spannung 110 V, 60 Hz, GMTU18.

/ Sistema de iluminación modular con elementos electrificados a baja tensión 12 V. componibles con módulos L. 1200 mm. En el canal porta focos, de metal pintado blanco o negro, o de chapa bruta no tratada, es posible colocar focos fijos magnéticamente, y orientables de un máximo de 4 focos (3 para mercado EE.UU.) para módulo L. 1200 mm. y 1 foco para módulo L. 500 mm. Las apliques son de 2 tipologías: con luz concentrada (con cono de luz de 24°), o con luz difundida (cono de luz de 45°). Versión para empotrar en el techo. Módulo electrificado a empotrar porta apliques, con 2 tapas de cierre L. 500 mm. GMTU06 / Alimentación 110 V, 60 Hz, GMTU15. Módulo electrificado a empotrar porta apliques, con 2 tapas de cierre L. 1200 mm. GMTU07 / Alimentación 110 V, 60 Hz, GMTU16. Módulo electrificado a empotrar porta apliques, terminal, con 1 tapa de cierre L. 1200 mm. GMTU08 / Alimentación 110 V, 60 Hz, GMTU17. Módulo electrificado a empotrar porta apliques, central, L. 1200 mm. GMTU09 / Alimentación 110 V, 60 Hz, GMTU18.

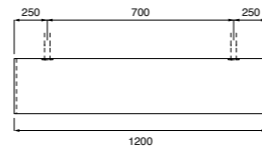

### T18

/ Sistema di illuminazione modulare ad elementi elettrificati a bassa tensione 12 V, componibili con moduli L. 1200 mm. Nel canale porta fari, in metallo verniciato bianco o nero, o in lamiera grezza non trattata, è possibile l'alloggiamento di fari fissati magneticamente, e orientabili in un massimo di 4 fari (3 fari per versione USA) per modulo L. 1200 mm. e 1 fero per modulo L. 500 mm. I fari sono di 2 tipologie: con luce concentrata (con cono di luce di 24°), o con luce diffusa (cono di luce di 45°). Versione per fissaggio a soffitto o sospesa con tiranti. Modulo elettrificato porta fari, con 2 tappi di chiusura in finitura, con 2 fori per tiranti L. 1200 mm. GMTU01 / Tensione 110 V, 60 Hz, GMTU10. Modulo elettrificato porta fari, terminale, con tappo di chiusura in finitura, con 1 foro per L. 1200 mm. GMTU02 / Tensione 110 V, 60 Hz, GMTU11. Modulo elettrificato porta fari in finitura, centrale, con 1 foro per tirante L. 1200 mm. GMTU03 / Tensione 110 V, 60 Hz, GMTU12. Modulo elettrificato porta fari in finitura, centrale, senza foro per tirante L. 1200 mm. GMTU04 / Tensione 110 V, 60 Hz, GMTU13. Modulo ad angolo 90°, in finitura, senza foro per tirante (Faro non inseribile) L. 500 x 500 mm. GMTU05 / Tensione 110 V, 60 Hz, GMTU14.

/ Modular lighting system, composed by electrified elements with low consumption (12 V) and modules 1200 mm. long. In the tube, in white or black-lacquered metal or in not-treated raw plate, adjustable spotlights, equipped with magnetic support, can be fixed. Max. 4 spotlights (3 spotlights for US version) can be positioned in a 1200 mm. module and 1 spotlight in a 500 mm. module. The spotlights can have a concentrated light (with 24° light cone), or a diffused light (with 45° light cone). Ceiling-fixed or suspended, with rods, versions. Electrified module for spotlights, with 2 finished terminals and 2 holes for rods W. 1200 mm. GMTU01 / Voltage 110 V, 60 Hz, GMTU10. Terminal electrified module for spotlights, with finished terminal left or right, 1 hole for rod W. 1200 mm. GMTU02 / Voltage 110 V, 60 Hz, GMTU11. Central-electrified module for spotlights, with hole for rod W. 1200 mm. GMTU03 / Voltage 110 V, 60 Hz, GMTU12. Central-electrified module for spotlights, without hole for rod W. 1200 mm. GMTU04 / Voltage 110 V, 60 Hz, GMTU13. 90° corner module in finish, without hole for rod (Spot-light can not be fitted) W. 500 x 500 mm. GMTU05 / Voltage 110 V, 60 Hz, GMTU14.

/ Systèmes d'éclairage modulaires à éléments électrifiés à basse tension 12 V, à composer avec modules de L. 1200 mm. dans le rail porte-spots, en métal peint blanc ou noir, ou en tôle brute non traitée, le logement de spots fixés magnétiquement, et orientables est possible pour un maximum de 4 spots (3 spots pour marché USA) pour module L. 1200 mm. et 1 spot pour module L. 500 mm. Ils sont de deux typologies : avec lumière concentrée (avec cône de lumière de 24°), ou avec lumière diffuse (cône de lumière de 45°). Version pour fixation au plafond ou à suspension avec tirants. Module électrifié porte-spots, avec 2 bouchons de fermeture en finition, avec 2 trous pour tirants, L. 1200 mm. GMTU01 / Alimentation 110 V, 60 Hz, GMTU10. Module électrifié porte-spots, d'extrémité, avec bouchon de fermeture en finition, avec 1 trou pour tirant L. 1200 mm. GMTU02 / Alimentation 110 V, 60 Hz, GMTU11. Module électrifié porte-spots, en finition, central, avec 1 trou pour tirant L. 1200 mm. GMTU03. / Alimentation 110 V, 60 Hz, GMTU12. Module électrifié porte-spots, en finition, central, sans trou pour tirant L. 1200 mm. GMTU04 / Alimentation 110 V, 60 Hz, GMTU13. Module électrifié, en finition, d'angle 90°, en finition, sans trou pour tirant (spot non insérable) L. 500 x 500 mm. GMTU05 Alimentation 110 V, 60 Hz, GMTU14.

/ Modulares Niedervolt-Beleuchtungssystem, (12 V), mit Modulen B. 1200 mm. In der Lichtleiste aus weiß oder schwarz lackiertem oder unbehandeltem Metall finden je Modul B. 1200 mm. max. 4 (3 für amerik. Markt) und je Modul B. 500 mm. max. 1 bewegliche und mittels Magnet befestigte Spots ihren Sitz. Mit 2 Lichttypologien: Konzentriertes Licht (Lichtkegel 24°) oder Streulicht (Lichtkegel 45°) Decken-oder Hängeversion mit Spannstangen. Lichtleiste für Spots, mit 2 Verschlusskappen in Ausführung und mit 2 Ausschnitten für Spannstangen B. 1200 mm. GMTU01 / Spannung 110 V, 60 Hz, GMTU10. Abschluss-Lichtleiste für Spots, mit Verschlusskappe in Ausführung und mit 1 Ausschnitt für Spannstange B. 1200 mm. GMTU02 / Spannung 110 V, 60 Hz, GMTU11. Lichtleiste für Spots, mittig, in Ausführung mit 1 Ausschnitt für Spannstange. B. 1200 mm. GMTU03 Spannung 110 V, 60 Hz, GMTU12. Lichtleiste für Spots, mittig, in Ausführung ohne Ausschnitt für Spannstange. B. 1200 mm. GMTU04 / Spannung 110 V, 60 Hz, GMTU13. 90° Eck-Lichtleiste für Spots, in Ausführung ohne Ausschnitt für Spannstange (Spot nicht einsetzbar) B. 500 x 500 mm. GMTU05 / Spannung 110 V, 60 Hz, GMTU14.

/ Sistema de iluminación modular con elementos electrificados a baja tensión 12 V. componibles con módulos L. 1200 mm. En el canal porta focos, de metal pintado blanco o negro, o de chapa bruta no tratada, es posible colocar focos fijos magnéticamente, y orientables de un máximo de 4 focos (3 para mercado EE.UU.) para módulo L. 1200 mm. y 1 foco para módulo L. 500 mm. Las apliques son de 2 tipologías: con luz concentrada (con cono de luz de 24°), o con luz difundida (cono de luz de 45°). Versión para fijación en el techo o suspendida con tirantes. Módulo electrificado porta apliques, con 2 tapas de cierre en acabado, con 2 huecos para tirantes L. 1200 mm. GMTU01 / Alimentación 110 V, 60 Hz, GMTU10. Módulo electrificado porta apliques, terminal, con tapa de cierre en acabado, con 1 hueco para tirante L. 1200 mm. GMTU02 / Alimentación 110 V, 60 Hz, GMTU11. Módulo electrificado porta apliques, central, con 1 hueco para tirante L. 1200 mm. GMTU03 / Alimentación 110 V, 60 Hz, GMTU12. Módulo electrificado porta apliques, central, sin hueco para tirante L. 1200 mm. GMTU04 / Alimentación 110 V, 60 Hz, GMTU13. Módulo ángulo 90°, sin hueco para tirante (No posible insertar aplique) L. 500 x 500 mm. GMTU05 / Alimentación 110 V, 60 Hz, GMTU14.



## Complementi, Specchi, Lampade Complementary Items, Mirrors, Lamps

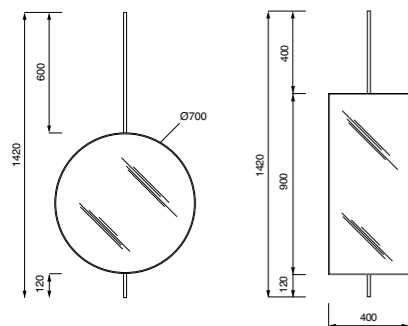

### Elementi

/ Specchiera con cornice in alluminio verniciato bronzo. Profilo tubolare in acciaio inox Ø15 mm verniciato bronzo. Circolare: L. 700 P. 70 H. 1420 mm. cod. OODA01. Rettangolare: L. 400 P. 70 H. 1420 mm. cod. OOGA01.  
/ Mirror with frame in aluminium, bronze painted. Ø15 mm tubular profile in stainless steel, bronze painted. Round: L. 700 P. 70 H. 1420 mm. cod. OODA01. Rectangular: L. 400 P. 70 H. 1420 mm. cod. OOGA01.  
/ Miroir avec cadre en aluminium peint bronze. Profil tubulaire en acier inox Ø15 peint bronze. Circulaire: L. 700 P. 70 H. 1420 mm. cod. OODA01. Rectangulaire: L. 400 P. 70 H. 1420 mm. cod. OOGA01.  
/ Spiegel mit Rahmen aus Aluminium, lackiert Bronze. Rohrprofil Ø15 mm aus Edelstahl, lackiert Bronze. Rund: L. 700 P. 70 H. 1420 mm. Cod. OODA01. Rechteckig: L. 400 P. 70 H. 1420 mm. Cod. OOGA01.  
/ Espejo con marco de aluminio pintado bronzo. Perfil tubular de acero inox Ø15 mm pintado bronzo. Circular: L. 700 P. 70 H. 1420 mm. cod. OODA01. Rectangular: L. 400 P. 70 H. 1420 mm. cod. OOGA01.

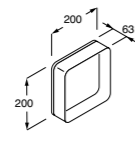

### Kaja

/ Specchio, 200 x 200 x 63 mm, realizzato in plexiglass trasparente sp. 50 mm, con supporto di fissaggio a parete in acciaio inox AISI 304, OJAQ01.  
/ Mirror, 200 x 200 x 63 mm, in trasparent plexiglass th. 50 mm, with support for wall mounting in stainless steel AISI 304, OJAQ01.  
/ Miroir, 200 x 200 x 63 mm, en plexiglas transparent, 50 mm. d'épaisseur. Avec support de fixation à paroi en acier inoxydable AISI 304, OJAQ01.  
/ Spiegel, 200 x 200 x 63 mm, aus transparentem Plexiglas St. 50 mm, Träger mit Wandhalter aus Edelstahl AISI 304, OJAQ01.  
/ Espejo, 200 x 200 x 63 mm, en plexiglás transparente de alto espesor. Soporte en acero inoxidable AISI 304. OJAQ01.

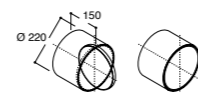

### Index

/ Specchio bifacciale, L. 220, P. 150, H. 220 mm, struttura cilindrica in acciaio inox satinato. Specchi assemblati su supporto girevole. Lato 1: specchio piano Ø 200 mm; lato 2: specchio a 2 ingrandimenti Ø 200 mm. OIAB01.  
/ Double-sided mirror, W. 220, D. 150, H. 220 mm, with cylindrical structure in satin stainless steel. Mirrors mounted on rotating support. Side 1: plane mirror ø 200 mm. Side 2: 2 x magnifying mirror ø 200 mm. OIAB01.  
/ Miroir double-face, L. 220, P. 150, H. 220 mm, avec structure cylindrique en acier inox satiné. Miroirs assemblés sur support pivotant. Côté 1: miroir plan ø 200 mm. Côté 2: miroir à 2 grossissements ø 200 mm. OIAB01.  
/ Zweiseitiger Spiegel, B. 220 / T. 150 / H. 220 mm, mit zylinderförmig aus satiniertem Edelstahl. Auf drehbarem Träger montierte Spiegel. Seite 1: flacher Spiegel ø 200 mm. Seite 2: Spiegel mit 2 Vergrößerungen ø 200 mm.  
/ Espejo de dos caras, L. 220 / P. 150 / H. 220 mm, con estructura cilíndrica en acero inoxidable satinado. Espejos montados en soporte giratorio. Lado 1: espejo llano ø 200 mm. Lado 2: espejo de 2 aumentos ø 200 mm.

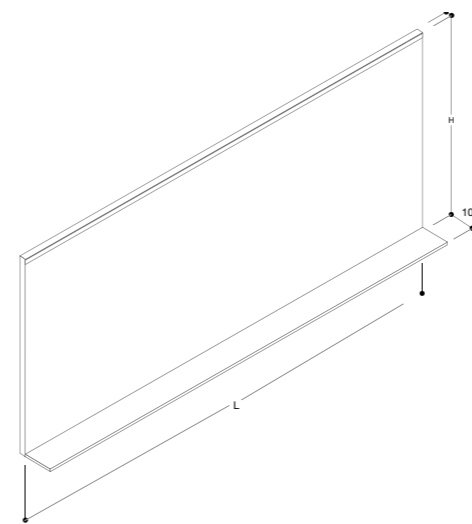

### Ledline

/ Specchio orizzontale con mensola, a misura Cliente, con barra a LED singola. Telaio in alluminio spessore 31 mm. Versione anodizzato naturale, verniciato bianco opaco o nero opaco. Illuminazione: a LED. Alimentazione: 230 V - 50 Hz, Europa / 110 V - 60 Hz, USA. Potenza massima 10 W per metro lineare. L min 900 mm / max 1800 mm - P. 131 mm, H min 500 mm / max 700 mm. cod. OLBA001, H min 701 mm / max 900 mm cod. OLBA002.  
/ Customised horizontal mirror with shelf, with single LED bar. 31 mm. thick aluminium frame. Available versions: naturally anodised, matt white or matt black painted. Lighting: LED. Voltage: 230 V - 50 Hz, Europe / 110 V - 60 Hz, USA. Max. power: 10 W per linear metre. L min 900 mm / max 1800 mm - P. 131 mm, H min 500 mm / max 700 mm. cod. OLBA001, H min 701 mm / max 900 mm cod. OLBA002.  
/ Miroir horizontal avec tablette sur mesure Client, avec barre à LED individuelle. Cadre en aluminium épaisseur 31 mm. Version anodisé naturel, peint blanc ou mat ou noir mat. Eclairage: à LED. Alimentation: 230 V - 50 Hz, Europe / 110 V - 60 Hz, USA. Puissance maximum: 10 W par mètre linéaire. L min 900 mm / max 1800 mm - P. 131 mm, H min 500 mm / max 700 mm. cod. OLBA001, H min 701 mm / max 900 mm cod. OLBA002.  
/ Horizontaler Spiegel mit Regal nach Kundenmaß, mit einer LED-Leiste. Aluminiumrahmen Stärke 31 mm. Ausführung eloxiert natur, lackiert mattweiß oder mattschwarz. Beleuchtung: LED. Stromzuführung: 230 V - 50 Hz, Europa / 110 V - 60 Hz, USA. Leistung max.: 10 W je lfd. Meter. L min 900 mm / max 1800 mm - P. 131 mm, H min 500 mm / max 700 mm. cod. OLBA001, H min 701 mm / max 900 mm cod. OLBA002.  
/ Espejo horizontal CON MENSULA a medida cliente, con barra LED individual. Armazón de aluminio de 31 mm. de espesor. Versión anodizado natural, pintado blanco mate o negro mate. Iluminación: LED. Alimentación: 230 V - 50 Hz, Europa / 110 V - 60 Hz, EE.UU. Potencia máxima: 10 W por metro lineal. L min 900 mm / max 1800 mm - P. 131 mm, H min 500 mm / max 700 mm. cod. OLBA001, H min 701 mm / max 900 mm cod. OLBA002.

**Complementi, Specchi, Lampade**  
Complementary Items, Mirrors, Lamps

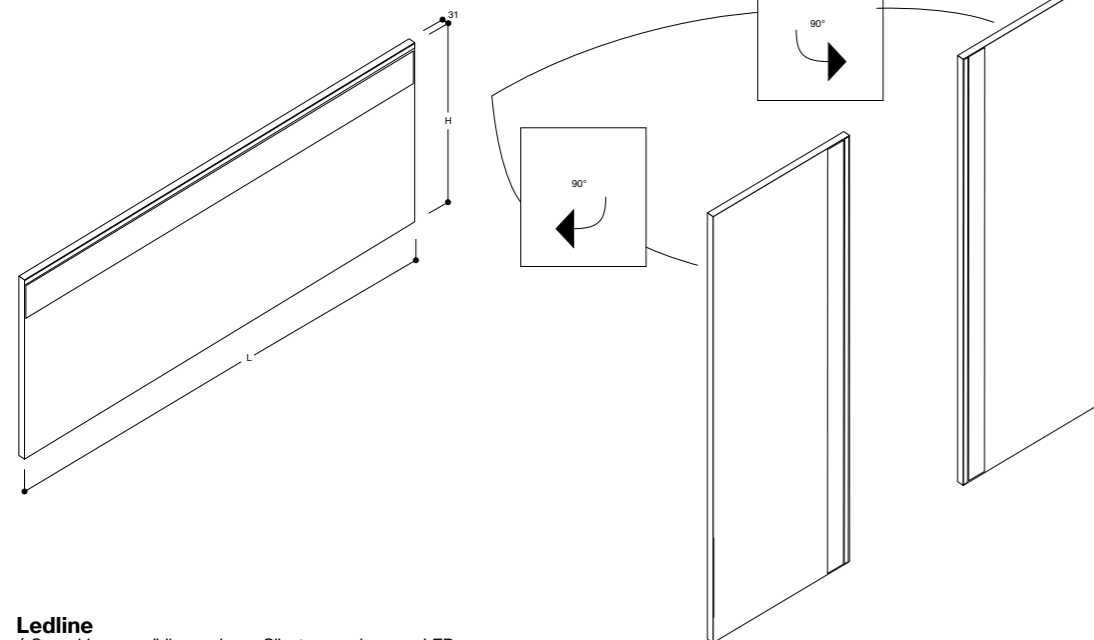

**Ledline**

/ Specchio reversibile a misura Cliente, con barra a LED singola. Lampada su lato superiore. Può essere ruotata di 90° (rotazione oraria o antioraria). Telaio in alluminio spessore 31 mm. Versione anodizzato naturale, verniciato bianco opaco o nero opaco. Illuminazione: a LED. Alimentazione: 230 V - 50 Hz, Europa / 110 V - 60 Hz, USA. Potenza massima 10 W per metro lineare. L min 900 mm / max 3000 mm - P. 31 mm. H min 400 mm / max 650 mm cod. OLBB001, H min 651 mm / max 1200 mm cod. OLBB002.

/ Customised reversible mirror, with single LED bar. Lamp can be installed on top side and can rotate 90° (counter-clockwise or not). 31 mm. thick aluminium frame. Available versions: naturally anodised, matt white or matt black painted. Lighting: LED. Voltage: 230 V - 50 Hz, Europe / 110 V - 60 Hz, USA. Max. power: 10 W per linear metre. L min 900 mm / max 3000 mm - P. 31 mm. H min 400 mm / max 650 mm cod. OLBB001, H min 651 mm / max 1200 mm cod. OLBB002.

/ Miroir réversible sur mesure Client, avec barre à LED individuelle. Lampe sur côté supérieur. Elle peut être tournée de 90° (rotation dans le sens des aiguilles d'une montre et dans le sens inverse). Cadre en aluminium épaisseur 31 mm. Version anodisé naturel, peint blanc ou mat ou noir mat. Eclairage: à LED. Alimentation: 230 V - 50 Hz, Europe / 110 V - 60 Hz, USA. Puissance maximum: 10 W par mètre linéaire. L min 900 mm / max 3000 mm - P. 31 mm. H min 400 mm / max 650 mm cod. OLBB001, H min 651 mm / max 1200 mm cod. OLBB002.

/ Umkehrbarer Spiegel nach Kundenmaß, mit einer LED-Leiste. Leuchte an der Oberseite. Lässt sich um 90° drehen (im/gegen den Uhrzeigersinn). Aluminiumrahmen Stärke 31 mm. Ausführung eloxiert natur, lackiert mattweiß oder mattschwarz. Beleuchtung: LED. Stromzuführung: 230 V - 50 Hz, Europa / 110 V - 60 Hz, USA. Leistung max.: 10 W je lfd. Meter. L min 900 mm / max 3000 mm - P. 31 mm. H min 400 mm / max 650 mm cod. OLBB001, H min 651 mm / max 1200 mm cod. OLBB002.

/ Espejo reversible a medida cliente, con barra LED individual. Lámpara en lado superior. Se puede girar en 90° (rotación en el sentido de las agujas del reloj y el contrario). Armazón de aluminio de 31 mm. de espesor. Versión anodizado natural, pintado blanco mate o negro mate. Iluminación: LED. Alimentación: 230 V - 50 Hz, Europa / 110 V - 60 Hz, EE.UU. Potencia máxima: 10 W por metro lineal. L min 900 mm / max 3000 mm - P. 31 mm. H min 400 mm max 650 mm cod. OLBB001, H min 651 mm / max 1200 mm cod. OLBB002.

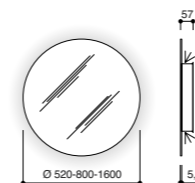

**Lotus**

/ Specchio retro illuminato con accensione tramite comando remoto. Illuminazione a LED. ø 520, P. 57 mm. Versione Europa OKAT01, versione USA OKAT02. ø 800, P. 57 mm. Versione Europa OKAT03, versione USA OKAT04. ø 1600 P. 57 mm. Versione Europa OKAT05, versione USA OKAT06. / Back illuminated mirror with remote control switching, LED lighting. ø 520, P. 57 mm. Version Europe OKAT01, version USA OKAT02. ø 800, P. 57 mm. Version Europe OKAT03, version USA OKAT04. ø 1600, P. 57 mm. Version Europe OKAT05, version USA OKAT06.

/ Miroir rétroéclairé avec commande déportée. Eclairage LED. ø 520, P. 57 mm. Version Europe OKAT01, version USA OKAT02. ø 800, P. 57 mm. Version Europe OKAT03, version USA OKAT04. ø 1600, P. 57 mm. Version Europe OKAT05, version USA OKAT06.

/ Spiegel mit rückseitiger Beleuchtung, Fernschalter Beleuchtung LED. ø 520, P. 57 mm. Version Europe OKAT01, Version USA OKAT02. ø 800, P. 57 mm. Version Europe OKAT03, Version USA OKAT04. ø 1600, P. 57 mm. Version Europa OKAT05, version USA OKAT06.

/ Espejo iluminado por detrás, mando a distancia. Iluminación LED. ø 520, P. 57 mm. Versión Europa OKAT01, versión USA OKAT02. ø 800, P. 57 mm. Versión Europa OKAT03, versión USA OKAT04. ø 1600, P. 57 mm. Versión Europa OKAT05, versión USA OKAT06.

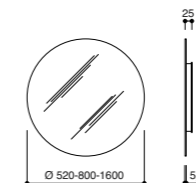

**Lotus**

/ Specchio senza illuminazione. Supporto posteriore in nobilitato. ø 520, P. 25 mm. cod. OKAS01. ø 800, P. 25 mm. cod. OKAS02. ø 1600, P. 25 mm. cod. OKAS03.

/ Mirror without lighting. Melamine-coated rear support. ø 520, P. 25 mm. cod. OKAS01. ø 800, P. 25 mm. cod. OKAS02. ø 1600, P. 25 mm. cod. OKAS03.

/ Miroir sans éclairage. Support arrière en mélaminé. ø 520, P. 25 mm. cod. OKAS01. ø 800, P. 25 mm. cod. OKAS02. ø 1600, P. 25 mm. cod. OKAS03.

/ Spiegel ohne Beleuchtung. Rückseitiger Träger mit Melaminbeschichtung. ø 520, P. 25 mm. cod. OKAS01. ø 800, P. 25 mm. cod. OKAS02. ø 1600, P. 25 mm. cod. OKAS03.

/ Espejo sin iluminación. Soporte trasero de madera ennoblecida. ø 520, P. 25 mm. cod. OKAS01. ø 800, P. 25 mm. cod. OKAS02. ø 1600, P. 25 mm. cod. OKAS03.

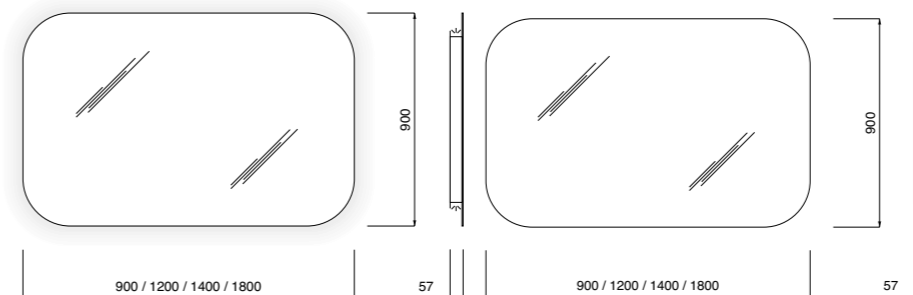

**Lotus**

/ Specchio retro illuminato con accensione tramite comando remoto. Illuminazione a LED. L. 900 P. 57 H. 900 cod. OKGL01; L. 1200 cod. OKGL02; L. 1400 cod. OKGL03; L. 1800 cod. OKGL04.

/ Back illuminated mirror with remote control switching, LED lighting. L. 900 P. 57 H. 900 cod. OKGL01; L. 1200 cod. OKGL02; L. 1400 cod. OKGL03; L. 1800 cod. OKGL04.

/ Miroir rétroéclairé avec commande déportée. Eclairage LED. L. 900 P. 57 H. 900 cod. OKGL01; L. 1200 cod. OKGL02; L. 1400 cod. OKGL03; L. 1800 cod. OKGL04.

/ Spiegel mit rückseitiger Beleuchtung, Fernschalter. Beleuchtung LED. L. 900 P. 57 H. 900 cod. OKGL01; L. 1200 cod. OKGL02; L. 1400 cod. OKGL03; L. 1800 cod. OKGL04.

/ Espejo iluminado por detrás, mando a distancia. Iluminación LED. L. 900 P. 57 H. 900 cod. OKGL01; L. 1200 cod. OKGL02; L. 1400 cod. OKGL03; L. 1800 cod. OKGL04.

**Lotus**

/ Specchio senza illuminazione. Supporto posteriore: telaio in alluminio. L. 900 P. 57 H. 900 cod. OKGS01; L. 1200 cod. OKGS02; L. 1400 cod. OKGS03; L. 1800 cod. OKGS04.

/ Mirror without lighting. Rear support: aluminium frame. L. 900 P. 57 H. 900 cod. OKGS01; L. 1200 cod. OKGS02; L. 1400 cod. OKGS03; L. 1800 cod. OKGS04.

/ Miroir sans éclairage. Support arrière: cadre en aluminium. L. 900 P. 57 H. 900 cod. OKGS01; L. 1200 cod. OKGS02; L. 1400 cod. OKGS03; L. 1800 cod. OKGS04.

/ Spiegel ohne Beleuchtung. Rückseitiger Träger: Alu-Rahmen. L. 900 P. 57 H. 900 cod. OKGS01; L. 1200 cod. OKGS02; L. 1400 cod. OKGS03; L. 1800 cod. OKGS04.

/ Espejo sin iluminación. Soporte trasero: armazón de aluminio. L. 900 P. 57 H. 900 cod. OKGS01; L. 1200 cod. OKGS02; L. 1400 cod. OKGS03; L. 1800 cod. OKGS04.

**Complementi, Specchi, Lampade**  
Complementary Items, Mirrors, Lamps

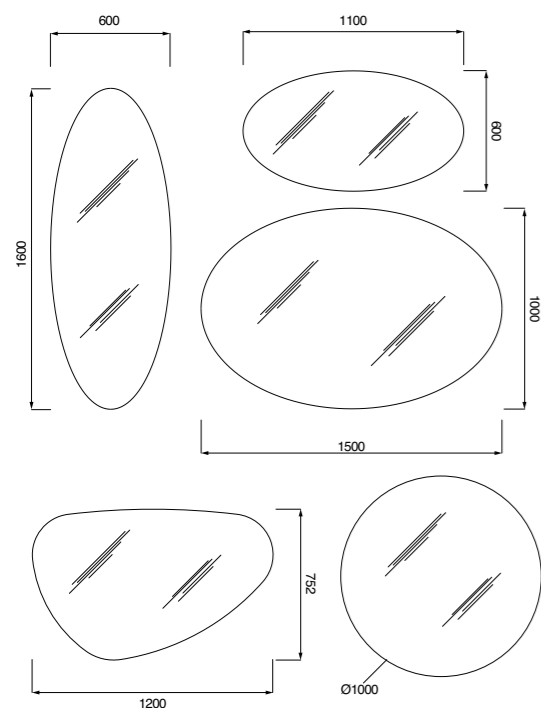

**Solstice**

/ Specchiera con supporto posteriore in MDF verniciato nero. Ellittica: L. 1000 P. 23 H. 1500 mm. cod. OSBV01. L. 600 P. 23 H. 1100 mm. cod. OSBV02. L. 600 P. 23 H. 1600 mm. cod. OSBV03. Triangolare: L. 1200 P. 23 H. 752 mm. cod. OSBG01. Circolare: Ø 1000 mm. cod. OSBT01.  
/ Mirror with rear support in black painted MDF. Oval: L. 1000 P. 23 H. 1500 mm. cod. OSBV01. L. 600 P. 23 H. 1100 mm. cod. OSBV02. L. 600 P. 23 H. 1600 mm. cod. OSBV03. Triangular: L. 1200 P. 23 H. 752 mm. cod. OSBG01. Round: Ø 1000 mm. cod. OSBT01.  
/ Miroir avec support arrière en MDF peint noir. Elliptique: L. 1000 P. 23 H. 1500 mm. cod. OSBV01. L. 600 P. 23 H. 1100 mm. cod. OSBV02. L. 600 P. 23 H. 1600 mm. cod. OSBV03. Triangulaire: L. 1200 P. 23 H. 752 mm. cod. OSBG01. Circulaire: Ø 1000 mm. cod. OSBT01.

/ Spiegel mit rückseitigem Träger in MDF schwarz lackiert. Ellipsenförmig: L. 1000 P. 23 H. 1500 mm. Cod. OSBV01. L. 600 P. 23 H. 1100 mm. Cod. OSBV02. L. 600 P. 23 H. 1600 mm. Cod. OSBV03. Dreieckig: L. 1200 P. 23 H. 752 mm. Cod. OSBG01. Rund: Ø 1000 mm. Cod. OSBT01.  
/ Espejo con soporte trasero de MDF pintado negro. Elíptico: L. 1000 P. 23 H. 1500 mm. cod. OSBV01. L. 600 P. 23 H. 1100 mm. cod. OSBV02. L. 600 P. 23 H. 1600 mm. cod. OSBV03. Triangular: L. 1200 P. 23 H. 752 mm. cod. OSBG01. Circular: Ø 1000 mm. cod. OSBT01.

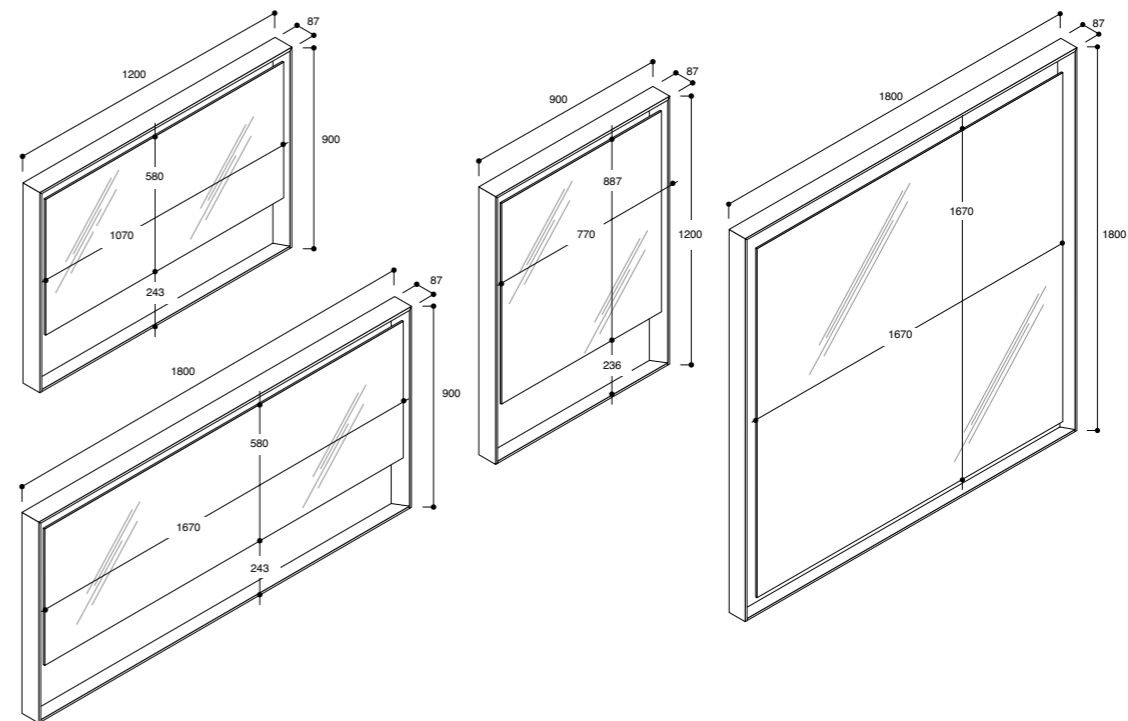

**SP14**

/ Specchio retro illuminato con cornice in finitura (Silcover o alcune essenze legno) spessore 12 mm. Accensione tramite comando remoto. Illuminazione LED a bassa tensione. Versione Europa/USA. L. 1200, P. 87, H. 900 mm, QQAL01. L. 1800, P. 87, H. 900 mm, QQAL02. L. 900, P. 87, H. 1200 mm, QQAL03. L. 1800, P. 87, H. 1800 mm, QQAL04.  
/ Back illuminated mirror with finished frame (Silcover or wood - only some species), th. 12 mm. Remote control switching. LED lighting, low consumption. Europe/USA version, L. 1200, P. 87, H. 900 mm, QQAL01. L. 1800, P. 87, H. 900 mm, QQAL02. L. 900, P. 87, H. 1200 mm, QQAL03. L. 1800, P. 87, H. 1800 mm, QQAL04.

/ Miroir rétroéclairé avec cadre en finition (Silcover ou bois - seulement quelques essence), épaisseur 12 mm. Commande déportée. Eclairage LED à basse tension. Version Europa/USA. L. 1200, P. 87, H. 900 mm, QQAL01. L. 1800, P. 87, H. 900 mm, QQAL02. L. 900, P. 87, H. 1200 mm, QQAL03. L. 1800, P. 87, H. 1800 mm, QQAL04.  
/ Spiegel mit rückseitiger Beleuchtung mit Rahmen in Ausführung (Silcover oder Holz - nur einige Ausführungen), St. 12 mm. Fernschalter. Beleuchtung LED mit Niederspannung. Version Europa/USA. L. 1200, P. 87, H. 900 mm, QQAL01. L. 1800, P. 87, H. 900 mm, QQAL02. L. 900, P. 87, H. 1200 mm, QQAL03. L. 1800, P. 87, H. 1800 mm, QQAL04.

/ Espejo iluminado por detrás con marco en acabado (Silcover o madera - sólo algunos acabados), esp. 12 mm. Mando a distancia. Iluminación LED a baja tensión. Versión Europa/USA. L. 1200, P. 87, H. 900 mm, QQAL01. L. 1800, P. 87, H. 900 mm, QQAL02. L. 900, P. 87, H. 1200 mm, QQAL03. L. 1800, P. 87, H. 1800 mm, QQAL04.

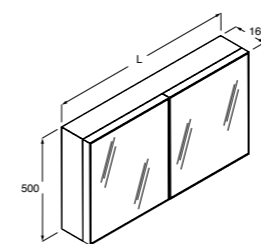

**Square**

/ Specchio contenitore in alluminio anodizzato con 2 ante e 2 ripiani. Fianchi finiti in specchio: versione esterna H. 500, L. 900, P. 160 mm. OSAC01 / H. 500, L. 1200, P. 160 mm. OSAC03. Fianchi in alluminio: versione da incasso H. 500, L. 900, P. 160 mm. OSAC02 / H. 500, L. 1200, P. 160 mm. OSAC04.  
/ Mirror with compartment in anodised aluminium with 2 doors and 2 shelves. Mirrored finished sides: not recessed version H. 500, W. 900, D. 160 mm. OSAC01 / H. 500, L. 1200, P. 160 mm. OSAC03. Aluminium finished sides: recessed version H. 500, W. 900, D. 160 mm. OSAC02 / H. 500, L. 1200, P. 160 mm. OSAC04.

/ Miroir / meuble en aluminium anodisé avec 2 portes et 2 étagères. Côté fini en miroir : variante avec meuble extérieur H. 500, L. 900, P. 160 mm. OSAC01 / H. 500, L. 1200, P. 160 mm. OSAC03. Côté fini en aluminium : variante pour encastrer dans le mur H. 500, L. 900, P. 160 mm. OSAC02 / H. 500, L. 1200, P. 160 mm. OSAC04.  
/ Spiegelschrank aus eloxiertem Aluminium mit 2 Türen und 2 Fachböden. Seiten in Spiegelausführung: Außenversion H. 500 mm, L. 900 mm, T. 160 mm. OSAC01 / H. 500, L. 1200, T. 160 mm. OSAC03. Seiten in Aluminiumausführung: Einbauversion: H. 500 mm, L. 900 mm, T. 160 mm. OSAC02 / H. 500, L. 1200, T. 160 mm. OSAC04.

/ Espejo contenedor de aluminio anodizado con dos puertas y 2 estantes interiores. Costados en acabado espejo: versión externa H. 500, L. 900, P. 160 mm. OSAC01 / H. 500, L. 1200 P. 160 mm. OSAC03. Costados en acabado aluminio: versión empotrada H. 500, L. 900, P. 160 mm. OSAC02 / H. 500, L. 1200, P. 160 mm. OSAC04.

**Complementi, Specchi, Lampade**  
Complementary Items, Mirrors, Lamps

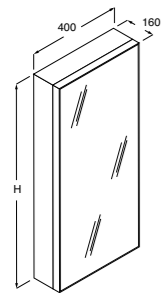

**Square**

/ Specchiera con supporto posteriore in MDF verniciato nero. Ellittica: L. 1000 P. 23 H. 1500 mm. cod. OSBV01. L. 600 P. 23 H. 1100 mm. cod. OSBV02. L. 600 P. 23 H. 1600 mm. cod. OSBV03. Triangolare: L. 1200 P. 23 H. 752 mm. cod. OSBG01. Circolare: Ø 1000 mm. cod. OSBT01.  
/ Mirror with rear support in black painted MDF. Oval: L. 1000 P. 23 H. 1500 mm. cod. OSBV01. L. 600 P. 23 H. 1100 mm. cod. OSBV02. L. 600 P. 23 H. 1600 mm. cod. OSBV03. Triangular: L. 1200 P. 23 H. 752 mm. cod. OSBG01. Round: Ø 1000 mm. cod. OSBT01.  
/ Miroir avec support arrière en MDF peint noir. Elliptique: L. 1000 P. 23 H. 1500 mm. cod. OSBV01. L. 600 P. 23 H. 1100 mm. cod. OSBV02. L. 600 P. 23 H. 1600 mm. cod. OSBV03. Triangulaire: L. 1200 P. 23 H. 752 mm. cod. OSBG01. Circulaire: Ø 1000 mm. cod. OSBT01.

/ Miroir/meuble en aluminium anodisé avec 1 porte à droite ou gauche. Côté fini en miroir : variante avec meuble extérieur H. 1200, L. 400, P. 160 mm. OSAC05 / H. 1600, L. 400, P. 160 mm. OSAC07. Côté fini en aluminium : variante pour encastrement dans le mur H. 1200, L. 400, P. 160 mm. OSAC06 / H. 1600, L. 400, P. 160 mm. OSAC08.  
/ Spiegelschrank aus eloxiertem Aluminium mit 1 Tür (Türscharniere rechts oder links). Seiten in Spiegelausführung: Außenversion H. 1200 mm, L. 400 mm, T. 160 mm. OSAC05 / H. 1600, L. 400, T. 160 mm. OSAC07. Seiten in Aluminiumausführung: Einbauversion: H. 1200 mm, L. 400 mm, T. 160 mm. OSAC06 / H. 1600, L. 400, T. 160 mm. OSAC08.

/ Espejo contenedor de aluminio anodizado con una puerta reversible. Costados en acabado espejo: versión externa H. 1200, L. 400, P. 160 mm. OSAC05 / H. 1600, L. 400, P. 160 mm. OSAC07. Costados en acabado aluminio: versión empotrada H. 1200, L. 400, P. 160 mm. OSAC06 / H. 1600, L. 400, P. 160 mm. OSAC08.

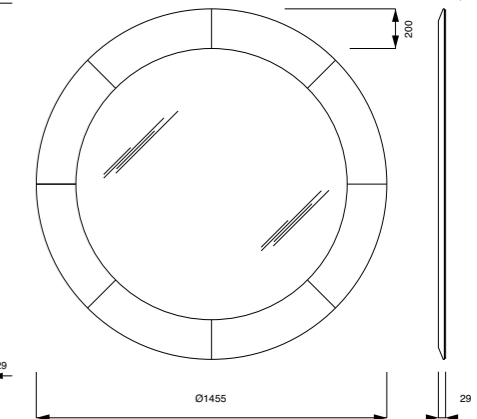
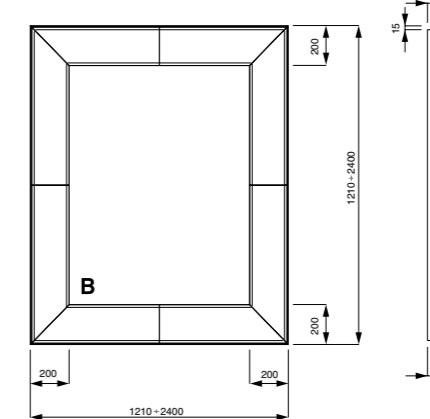
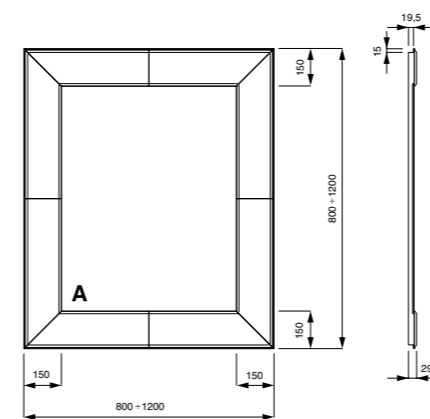

**Veneziana**

/ Specchiera con cornice in specchio molato, montata su telaio in alluminio anodizzato nero, posizionamento sia orizzontale che verticale. Dimensioni: L. min. 800 / max 1200, H. min. 800 / Max 1200 mm. Superficie min. 0,64 m<sup>2</sup> – max. 0,9 m<sup>2</sup> – OVMC01. Superficie min. 0,91 m<sup>2</sup> – max. 1,2 m<sup>2</sup> – OVMC02. Superficie min. 1,21 m<sup>2</sup> – max. 1,44 m<sup>2</sup> – OVMC03. Dimensioni: L. min 1210/ max 2400, H. min 1210 / max 2400 mm. Superficie min. 1,46 m<sup>2</sup> – max. 1,82 m<sup>2</sup> – OVMC04. Superficie min. 1,83 m<sup>2</sup> – max. 2,28 m<sup>2</sup> – OVMC05. Superficie min. 2,29 m<sup>2</sup> – max. 2,7 m<sup>2</sup> – OVMC06. Superficie min. 2,71 m<sup>2</sup> – max. 3,0 m<sup>2</sup> – OVMC07. Superficie min. 3,1 m<sup>2</sup> – max. 3,4 m<sup>2</sup> – OVMC08. Superficie min. 3,41 m<sup>2</sup> – max. 3,8 m<sup>2</sup> – OVMC09. Superficie min. 3,81 m<sup>2</sup> – max. 4,2 m<sup>2</sup> – OVMC10. Superficie min. 4,21 m<sup>2</sup> – max. 4,8 m<sup>2</sup> – OVMC11.  
/ Mirror with frame made of bevelled mirror, mounted on supporting frame in black anodised aluminium, both horizontal and vertical assembly. Measures W. min 800 / max 1200, H. min 800 / max 1200 mm. Surface min. 0,64 m<sup>2</sup> – max. 0,9 m<sup>2</sup> – OVMC01. Surface min. 0,91 m<sup>2</sup> – max. 1,2 m<sup>2</sup> – OVMC02. Surface min. 1,21 m<sup>2</sup> – max. 1,44 m<sup>2</sup> – OVMC03. Measures W. min 1210 / max 2400, H. min 1210/ max 2400 mm. Surface min. 1,46 m<sup>2</sup> – max. 1,82 m<sup>2</sup> – OVMC04. Surface min. 1,83 m<sup>2</sup> – max. 2,28 m<sup>2</sup> – OVMC05. Surface min. 2,29 m<sup>2</sup> – max. 2,7 m<sup>2</sup> – OVMC06. Surface min. 2,71 m<sup>2</sup> – max. 3,0 m<sup>2</sup> – OVMC07. Surface min. 3,1 m<sup>2</sup> – max. 3,4 m<sup>2</sup> – OVMC08. Surface min. 3,41 m<sup>2</sup> – max. 3,8 m<sup>2</sup> – OVMC09. Surface min. 3,81 m<sup>2</sup> – max. 4,2 m<sup>2</sup> – OVMC10. Surface min. 4,21 m<sup>2</sup> – max. 4,8 m<sup>2</sup> – OVMC11.  
/ Miroir avec cadre en miroir meulé et cadre de support en aluminium anodisé noir, prévu pour positionnement horizontal ou vertical. Dimensions : L. min 800 / max 1200, H. min 800 / max 1200 mm. Surface min. 0,64 m<sup>2</sup> – max. 0,9 m<sup>2</sup> – OVMC01. Surface min. 0,91 m<sup>2</sup> – max. 1,2 m<sup>2</sup> – OVMC02. Surface min. 1,21 m<sup>2</sup> – max. 1,44 m<sup>2</sup> – OVMC03. Dimensions : L. min 1200 / max 2400, H. min 1210 / max 2400 mm. Surface min. 1,46 m<sup>2</sup> – max. 1,82 m<sup>2</sup> – OVMC04. Surface min. 1,83 m<sup>2</sup> – max. 2,28 m<sup>2</sup> – OVMC05. Surface min. 2,29 m<sup>2</sup> – max. 2,7 m<sup>2</sup> – OVMC06. Surface min. 2,71 m<sup>2</sup> – max. 3,0 m<sup>2</sup> – OVMC07. Surface min. 3,1 m<sup>2</sup> – max. 3,4 m<sup>2</sup> – OVMC08. Surface min. 3,41 m<sup>2</sup> – max. 3,8 m<sup>2</sup> – OVMC09. Surface min. 3,81 m<sup>2</sup> – max. 4,2 m<sup>2</sup> – OVMC10. Surface min. 4,21 m<sup>2</sup> – max. 4,8 m<sup>2</sup> – OVMC11.

/ Spiegel mit Aussenrand aus geschliffenem Spiegel – Glas, Aussen-Rahmenstruktur aus Aluminium anodisiert schwarz, Positionierung vertikal wie horizontal möglich. Maße: B. min 800 / max 1200, H. min 800 / max 1200 mm. Oberfläche min. 0,64 m<sup>2</sup> – max. 0,9 m<sup>2</sup> – OVMC01. Oberfläche min. 0,91 m<sup>2</sup> – max. 1,2 m<sup>2</sup> – OVMC02. Oberfläche min. 1,21 m<sup>2</sup> – max. 1,44 m<sup>2</sup> – OVMC03. Maße: B. min 1200 / max 2400, H. min 1210 / max 2400 mm. Oberfläche min. 1,46 m<sup>2</sup> – max. 1,82 m<sup>2</sup> – OVMC04. Oberfläche min. 1,83 m<sup>2</sup> – max. 2,28 m<sup>2</sup> – OVMC05. Oberfläche min. 2,29 m<sup>2</sup> – max. 2,7 m<sup>2</sup> – OVMC06. Oberfläche min. 2,71 m<sup>2</sup> – max. 3,0 m<sup>2</sup> – OVMC07. Oberfläche min. 3,1 m<sup>2</sup> – max. 3,4 m<sup>2</sup> – OVMC08. Oberfläche min. 3,41 m<sup>2</sup> – max. 3,8 m<sup>2</sup> – OVMC09. Oberfläche min. 3,81 m<sup>2</sup> – max. 4,2 m<sup>2</sup> – OVMC10. Oberfläche min. 4,21 m<sup>2</sup> max. 4,8 m<sup>2</sup> – OVMC11.  
/ Espejo con marco de espejo biselado de 150 mm. Armazón aluminio anodizado negro. Se puede colocar tanto en horizontal como en vertical. L. min. 800 / max 1200, H. min. 800 / Max 1200 mm. Superficie min. 0,64 m<sup>2</sup> – max. 0,9 m<sup>2</sup> – OVMC01. Superficie min. 0,91 m<sup>2</sup> – max. 1,2 m<sup>2</sup> – OVMC02. Superficie min. 1,21 m<sup>2</sup> – max. 1,44 m<sup>2</sup> – OVMC03. L. min 1210/ max 2400, H. min 1210 / max 2400 mm. Superficie min. 1,46 m<sup>2</sup> – max. 1,82 m<sup>2</sup> – OVMC04. Superficie min. 1,83 m<sup>2</sup> – max. 2,28 m<sup>2</sup> – OVMC05. Superficie min. 2,29 m<sup>2</sup> – max. 2,7 m<sup>2</sup> – OVMC06. Superficie min. 2,71 m<sup>2</sup> – max. 3,0 m<sup>2</sup> – OVMC07. Superficie min. 3,1 m<sup>2</sup> – max. 3,4 m<sup>2</sup> – OVMC08. Superficie min. 3,41 m<sup>2</sup> – max. 3,8 m<sup>2</sup> – OVMC09. Superficie min. 3,81 m<sup>2</sup> – max. 4,2 m<sup>2</sup> – OVMC10. Superficie min. 4,21 m<sup>2</sup> – max. 4,8 m<sup>2</sup> – OVMC11.

**Veneziana**

/ Specchio circolare. Cornice in specchio molato da 200 mm. Supporto posteriore in MDF verniciato nero. Ø 1455 mm. Cod. OVAT01  
/ Round mirror. 200 mm. frame in bevelled mirror. Rear support in black painted MDF. Ø 1455 mm. Cod. OVAT01  
/ Miroir circulaire. Cadre en miroir meulé de 200 mm. Support arrière en MDF peint noir. Ø 1455 mm. Cod. OVAT01  
/ Rundspiegel. Rahmen aus geschliffenem Spiegelglas 200 mm. Rückseitiger Träger in MDF schwarz lackiert. Ø 1455 mm. Cod. OVAT01  
/ Espejo redondo. Marco de espejo biselado de 200 mm. Soporite trasero de MDF pintado negro. Ø 1455 mm. Cod. OVAT01.

## Complementi, Specchi, Lampade Complementary Items, Mirrors, Lamps

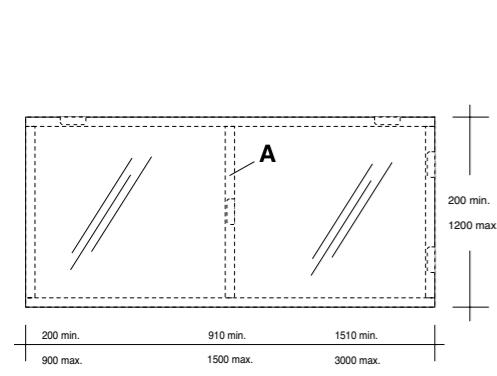

### Wk6

/ Specchiera a misura cliente, posizionabile sia in orizzontale che verticale, dimensioni da 200 – 900 a 200 – 1200 mm. OMAR11 / da 910 – 1500 a 200 – 1200 mm. OMAR12 / da 1510 – 3000 a 200 – 1200 mm, OMAR13.

/ Customised mirror, both horizontal and vertical, from 200 / 900 to 200 / 1200 mm. OMAR11 / from 910 – 1500 to 200 – 1200 mm. OMAR12 / from 1510 – 3000 to 200 – 1200 mm, OMAR13.

/ Miroir sur mesure client, positionnement horizontal ou vertical, dimensions de 200 / 900 à 200 / 1200 mm. OMAR11 / de 910 – 1500 à 200 – 1200 mm. OMAR12 / de 1510 – 3000 à 200 – 1200 mm, OMAR13.

/ Spiegel nach Kundenmaß, vertikal wie horizontal positionierbar, Maße von 200 / 900 bis 200 / 1200 mm. OMAR11 / von 910–1500 bis 200 – 1200 mm. OMAR12 / von 1510 – 3000 bis 200 – 1200 mm, OMAR13.

/ Espejo a medida cliente. Se puede colocar tanto en horizontal como en vertical. L.de 200 – 900 a 200 – 1200 mm. OMAR11 / L. de 910 – 1500 a 200 – 1200 mm. OMAR12 / de 1510 – 3000 a 200 – 1200 mm, OMAR13.

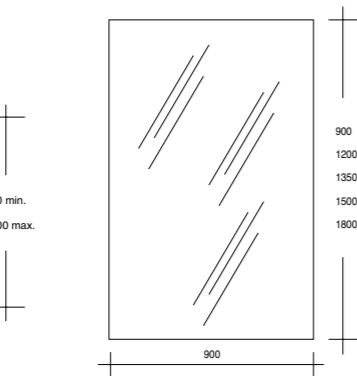

### Wk6

/ Specchiera con telaio in alluminio spessore 23 mm. in misura fissa, senza lampada, posizionabile sia in orizzontale che in verticale. 900 x900 mm. OMAR04 / 900 x 1200 mm. OMAR05 / 900 x 1350 mm. OMAR06 / 900 x 1500 mm. OMAR07 / 900 x 1800 mm. OMAR08.

/ Mirror with aluminium frame th. 23 mm. fixed sizes, without lamp - both horizontal and vertical. 900 x 900 mm. OMAR04 / 900 x 1200 mm. OMAR05 / 900 x 1350 mm. OMAR06 / 900 x 1500 mm. OMAR07 / 900 x 1800 mm. OMAR08.

/ Miroir avec cadre en aluminium ép. 23 mm. Taille fixe. Sans lampe. positionnement horizontal ou vertical. 900 x 900 mm. OMAR04 / 900 x 1200 mm. OMAR05 / 900 x 1350 mm. OMAR06 / 900 x 1500 mm. OMAR07 / 900 x 1800 mm. OMAR08.

/ Spiegel mit Aluminium-Rahmen T. 23 mm. Feste Größe, ohne Lampe, vertikal wie horizontal positionierbar. 900 x 900 mm. OMAR04 / 900 x 1200 mm. OMAR05 / 900 x 1350 mm. OMAR06 / 900 x 1500 mm. OMAR07 / 900 x 1800 mm. OMAR08.

/ Espejo a medida fija. Armazón aluminio de 23 mm. de espesor. Sin lámpara. Se puede colocar tanto en horizontal como en vertical. 900 x 900 mm. OMAR04 / 900 x 1200 mm. OMAR05 / 900 x 1350 mm. OMAR06 / 900 x 1500 mm. OMAR07 / 900 x 1800 mm. OMAR08.

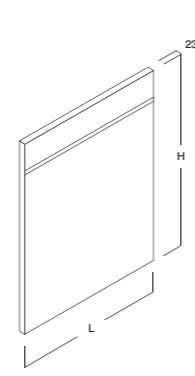

### Wk6

/ Specchio con barra a LED singola. Telaio alluminio spessore 23 mm. Versione anodizzato naturale, verniciato bianco opaco o nero opaco. Illuminazione: a LED. Accensione: prevedere a parete punto luce comandato in posizione centrata e relativo comando remoto. Alimentazione: 230 V - 50 Hz, Europa / 110 V - 60 Hz, USA. Può essere ruotato di 90° (rotazione oraria e antioraria). Rotazione sconsigliata per OMAL05. L. 900 x P. 23 x H. 900 mm. OMAL02. L. 900 x P. 23 x H. 1200 mm. OMAL03. L. 1200 x P. 23 x H. 1200 mm. OMAL04. L. 450 x P. 23 x H. 1800 mm. OMAL05.

/ Mirror with single LED bar. 23 mm. thick aluminium frame. Available versions: naturally anodised, matt white or matt black painted. Lighting: LED. Switch: on wall please arrange cable-centred positioned, and relative remote control. Voltage: 230 V - 50 Hz, Europe / 110 V - 60 Hz, USA. It can be rotated by 90° (anticlockwise or clockwise). Rotation not suggested for code OMAL05. L. 900 x P. 23 x H. 900 mm. OMAL02. L. 900 x P. 23 x H. 1200 mm. OMAL03. L. 1200 x P. 23 x H. 1200 mm. OMAL04. L. 450 x P. 23 x H. 1800 mm. OMAL05.

/ Miroir avec barre LED individuelle. Cadre aluminium épaisseur 23 mm. Version anodisé naturel, peint blanc mat ou noir mat. Eclairage: à LED. Allumage: commande électronique touch gradable avec LED de position. Alimentation: 230 V - 50 Hz, Europe / 110 V - 60 Hz, USA. Il ne peut pas pivoter. L. 1200 x P. 23 x H. 900 mm. OMAD01. L. 1800 x P. 23 x H. 900 mm. OMAD02. L. 1200 x P. 23 x H. 1200 mm. OMAD03. L. 1500 x P. 23 x H. 1200 mm. OMAD04. L. 1800 x P. 23 x H. 1200 mm. OMAD05.

/ Spiegel mit zwei LED-Lichtleisten. Rahmen aus Aluminium, Stärke 23 mm. Ausführung eloxiert natur, lackiert mattweiß oder mattschwarz. Beleuchtung: LED. Lichtschaltung: An der Wand mittig Stromanschluss und entsprechende Schaltung positionieren. Stromzuführung: 230 V - 50 Hz, Europa / 110 V - 60 Hz, USA. Mit 90° Drehung. (Im und gegen Uhrzeigersinn). Drehung nicht empfohlen für OMAL05. L. 900 x P. 23 x H. 900 mm. OMAL02. L. 900 x P. 23 x H. 1200 mm. OMAL03. L. 1200 x P. 23 x H. 1200 mm. OMAL04. L. 450 x P. 23 x H. 1800 mm. OMAL05.

/ Espejo con una barra LED. Armazón aluminio de 23 mm. de espesor. Versión anodizado natural, pintado blanco mate o negro mate. Iluminación: LED. Encendido: disponer a pared punto de corriente controlado en posición central y relativo mando a distancia. Alimentación: 230 V - 50 Hz, Europa / 110 V - 60 Hz, EE. UU. Puede ser girado en 90° (rotación hacia la derecha o hacia la izquierda). Rotación desaconsejada para OMAL05. L. 900 x P. 23 x H. 900 mm. OMAL02. L. 900 x P. 23 x H. 1200 mm. OMAL03. L. 1200 x P. 23 x H. 1200 mm. OMAL04. L. 450 x P. 23 x H. 1800 mm. OMAL05.

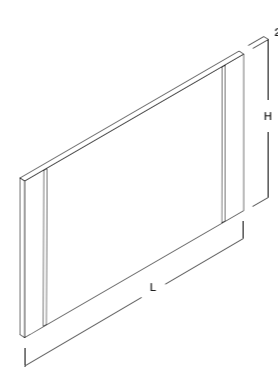

### Wk6

/ Specchio con doppia barra a LED. Telaio alluminio spessore 23 mm. Versione anodizzato naturale, verniciato bianco opaco o nero opaco. Illuminazione: a LED. Accensione: comando elettronico touch dimmerabile con LED di posizione. Alimentazione: 230 V - 50 Hz, Europa / 110 V - 60 Hz, USA. Non può essere ruotato. L. 1200 x P. 23 x H. 900 mm. OMAD01. L. 1800 x P. 23 x H. 900 mm. OMAD02. L. 1200 x P. 23 x H. 1200 mm. OMAD03. L. 1500 x P. 23 x H. 1200 mm. OMAD04. L. 1800 x P. 23 x H. 1200 mm. OMAD05.

/ Mirror with double LED bar. 23 mm. thick aluminium frame. Available versions: naturally anodised, matt white or matt black painted. Lighting: LED. Switch: electronic touch control with dimmer and positioning LED. Voltage: 230 V - 50 Hz, Europe / 110 V - 60 Hz, USA. It cannot be rotated. L. 1200 x P. 23 x H. 900 mm. OMAD01. L. 1800 x P. 23 x H. 900 mm. OMAD02. L. 1200 x P. 23 x H. 1200 mm. OMAD03. L. 1500 x P. 23 x H. 1200 mm. OMAD04. L. 1800 x P. 23 x H. 1200 mm. OMAD05.

/ Miroir avec double barre LED. Cadre aluminium épaisseur 23 mm. Version anodisé naturel, peint blanc mat ou noir mat. Eclairage: à LED. Allumage: commande électronique touch gradable avec LED de position. Alimentation: 230 V - 50 Hz, Europe / 110 V - 60 Hz, USA. Il ne peut pas pivoter. L. 1200 x P. 23 x H. 900 mm. OMAD01. L. 1800 x P. 23 x H. 900 mm. OMAD02. L. 1200 x P. 23 x H. 1200 mm. OMAD03. L. 1500 x P. 23 x H. 1200 mm. OMAD04. L. 1800 x P. 23 x H. 1200 mm. OMAD05.

/ Espejo con dos barras LED. Armazón aluminio de 23 mm. de espesor. Versión anodizado natural, pintado blanco mate o negro mate. Iluminación: LED. Encendido: mando electrónico touch regulable con dimmer con LED de posición. Alimentación: 230 V - 50 Hz, Europa / 110 V - 60 Hz, EE.UU. No puede ser girado. L. 1200 x P. 23 x H. 900 mm. OMAD01. L. 1800 x P. 23 x H. 900 mm. OMAD02. L. 1200 x P. 23 x H. 1200 mm. OMAD03. L. 1500 x P. 23 x H. 1200 mm. OMAD04. L. 1800 x P. 23 x H. 1200 mm. OMAD05.

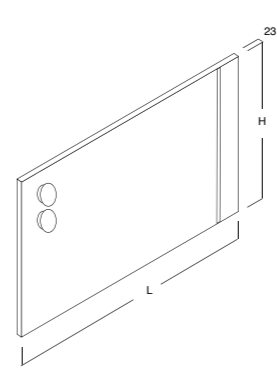

### Wk6

/ Specchio con barra a LED + 2 lampade BOCCIA. Telaio alluminio spessore 23 mm. Versione anodizzato naturale, verniciato bianco opaco o nero opaco. Illuminazione barra: a LED - Illuminazione BOCCIA: LED Acrich 2 dimmerabile 12 W (cadauna). Accensione LED: comando elettronico touch dimmerabile con LED di posizione. Accensione BOCCIA: comando on/off dimmerabile a pulsante. Non può essere ruotato. Alimentazione 230 V - 50 Hz, Europa: 1200 x 23 x 900 mm. OMAD06 S-D; 1800 x 23 x 900 mm. OMAD07 S-D; 2400 x 23 x 900 mm. OMAD08 S-D; 900 x 23 x 1200 mm. OMAD09 S-D; 1200 x 23 x 1200 mm. OMAD10 S-D. Alimentazione 110 V - 60 Hz, USA: 1200 x 23x 900 mm. OMAD11 S-D; 1800 x 23 x 900 mm. OMAD12 S-D; 2400 x 23 x 900 mm. OMAD13 S-D; 900 x 23 x 1200 mm. OMAD14 S-D; 1200 x 23 x 1200 mm. OMAD15.

/ Mirror with LED bar + 2 BOCCIA lamps. 23 mm. thick aluminium frame. Available versions: naturally anodised, matt white or matt black painted. Bar lighting: LED - BOCCIA lighting: LED Acrich 2 with dimmer 12 W (each). LED switch: electronic touch control with dimmer and positioning LED. Switch of BOCCIA lamp: on/off button control with dimmer. It cannot be rotated. Voltage 230 V - 50 Hz, Europa: 1200 x 23 x 900 mm. OMAD06 S-D; 1800 x 23 x 900 mm. OMAD07 S-D; 2400 x 23 x 900 mm. OMAD08 S-D; 900 x 23 x 1200 mm. OMAD09 S-D; 1200 x 23 x 1200 mm. OMAD10 S-D. Voltage 110 V - 60 Hz, USA: 1200 x 23 x 900 mm. OMAD11 S-D; 1800 x 23 x 900 mm. OMAD12 S-D; 2400 x 23 x 900 mm. OMAD13 S-D; 900 x 23 x 1200 mm. OMAD14 S-D; 1200 x 23 x 1200 mm. OMAD15.

/ Miroir avec barre LED + 2 lampes BOCCIA. Cadre aluminium épaisseur 23 mm. Version anodisé naturel, peint blanc mat ou noir mat. Eclairage barre : à LED- Eclairage BOCCIA: LED Acrich 2 gradable 12 W (chacune). Allumage LED: commande électronique touch gradable avec LED de position. Allumage BOCCIA: commande on/off gradable à bouton-poussoir. Il ne peut pas pivoter. Alimentation 230 V - 50 Hz, Europa: 1200x 23x 900 mm. OMAD06 S-D; 1800 x 23 x 900 mm. OMAD07 S-D; 2400 x 23 x 900 mm. OMAD08 S-D; 900 x 23 x 1200 mm. OMAD09 S-D; 1200 x 23 x 1200 mm. OMAD10 S-D. Alimentation 110 V - 60 Hz, USA: 1200 x 23 x 900 mm. OMAD11 S-D; 1800 x 23 x 900 mm. OMAD12 S-D; 2400 x 23 x 900 mm. OMAD13 S-D; 900 x 23 x 1200 mm. OMAD14 S-D; 1200 x 23 x 1200 mm. OMAD15.

/ Espejo con barra LED + 2 lámparas BOCCIA. Armazón aluminio de 23 mm. de espesor. Versión anodizado natural, pintado blanco mate o negro mate. Iluminación barra: LED - Iluminación BOCCIA: LED Acrich 2 regulable con dimmer 12 W (cada una). Encendido LED: mando electrónico touch regulable con dimmer con LED de posición. Encendido BOCCIA: mando on/off regulable con dimmer de pulsador. No puede ser girado. Alimentación 230 V - 50 Hz, Europa: 1200 x 23 x 900 mm. OMAD06 S-D; 1800 x 23 x 900 mm. OMAD07 S-D; 2400 x 23 x 900 mm. OMAD08 S-D; 900 x 23 x 1200 mm. OMAD09 S-D; 1200 x 23 x 1200 mm. OMAD10 S-D. Alimentación 110 V - 60 Hz, USA: 1200 x 23 x 900 mm. OMAD11 S-D; 1800 x 23 x 900 mm. OMAD12 S-D; 2400 x 23 x 900 mm. OMAD13 S-D; 900 x 23 x 1200 mm. OMAD14 S-D; 1200 x 23 x 1200 mm. OMAD15.

/ Spiegel mit LED-Lichtleiste + 2 BOCCIA Lampen. Rahmen aus Aluminium, Stärke 23 mm. Ausführung eloxiert natur, lackiert mattweiß oder mattschwarz. Lichtleiste: LED - Beleuchtung BOCCIA: LED Acrich 2 Dimmer (je) 12 W. LED-Schaltung: Dimmer-Touchschalter mit Positions-LED. Lichtschaltung BOCCIA: Dimmer ON/OFF Schalttaste. Nicht drehbar. Stromzuführung 230 V - 50 Hz, Europa: 1200 x 23 x 900 mm. OMAD06 S-D; 1800 x 23 x 900 mm. OMAD07 S-D; 2400 x 23 x 900 mm. OMAD08 S-D; 900 x 23 x 1200 mm. OMAD09 S-D; 1200 x 23 x 1200 mm. OMAD10 S-D. Stromzuführung 110 V - 60 Hz, USA: 1200 x 23 x 900 mm. OMAD11 S-D; 1800 x 23 x 900 mm. OMAD12 S-D; 2400 x 23 x 900 mm. OMAD13 S-D; 900 x 23 x 1200 mm. OMAD14 S-D; 1200 x 23 x 1200 mm. OMAD15.

/ Espejo con barra LED + 2 lámparas BOCCIA. Armazón aluminio de 23 mm. de espesor. Versión anodizado natural, pintado blanco mate o negro mate. Iluminación barra: LED - Iluminación BOCCIA: LED Acrich 2 regulable con dimmer 12 W (cada una). Encendido LED: mando electrónico touch regulable con dimmer con LED de posición. Encendido BOCCIA: mando on/off regulable con dimmer de pulsador. No puede ser girado. Alimentación 230 V - 50 Hz, Europa: 1200 x 23 x 900 mm. OMAD06 S-D; 1800 x 23 x 900 mm. OMAD07 S-D; 2400 x 23 x 900 mm. OMAD08 S-D; 900 x 23 x 1200 mm. OMAD09 S-D; 1200 x 23 x 1200 mm. OMAD10 S-D. Alimentación 110 V - 60 Hz, USA: 1200 x 23 x 900 mm. OMAD11 S-D; 1800 x 23 x 900 mm. OMAD12 S-D; 2400 x 23 x 900 mm. OMAD13 S-D; 900 x 23 x 1200 mm. OMAD14 S-D; 1200 x 23 x 1200 mm. OMAD15.

Alcuni prodotti ed allestimenti non sono parte del listino Boffi. Modifiche e migliorie ai prodotti potrebbero variare l'estetica delle soluzioni presentate.

Some products shown in this catalogue may not be in the Boffi product listing. Modifications and improvements to products could vary from the solutions presented.

Certains produits présentés dans ce catalogue ne sont pas de production Boffi. Modifications et améliorations pourraient changer l'esthétique des produits présentés.

Einige Produkte und Ausstellungware gehören nicht zu der Boffi Kollektion. Durch Änderungen oder Verbesserungen kann das Aussehen der gezeigten Produkte variieren.

Algunos productos y equipamientos no forman parte del listado Boffi. Los cambios y mejoras en los productos podrían variar la estética de las soluciones presentadas.

Boffi, azienda certificata ISO 9001:2008, progetta e realizza i propri prodotti esclusivamente in Italia. La certificazione ISO 14001:2004 garantisce anche il controllo sull'impatto ambientale derivato dai processi produttivi. Le politiche qualità e ambiente prevedono azioni di continuo miglioramento che coinvolgono tutta l'organizzazione. I prodotti Boffi sono coperti da garanzia per un periodo di tre anni dalla data di emissione del certificato di garanzia.

Each Boffi product is made in Italy in accordance with ISO 9001:2008 regulations. The ISO 14001:2004 standards ensure the environmental impact at every stage of production. The quality and environmental policies provide continuous improvement actions that involve the entire organization. Boffi products are guaranteed for 3 years, as of the date of the guarantee certificate issue.

Boffi, entreprise certifiée 9001:2008, conçoit et réalise ses produits exclusivement en Italie. La certification ISO 14001:2004 garantit également le contrôle de l'impact sur l'environnement dérivant des processus de production. Les politiques de qualité et environnement prévoient des actions d'amélioration continue qui intéressent l'organisation dans son ensemble. Le produits Boffi sont sous garantie pendant une période de trois ans à compter de la date d'émission du certificat de garantie.

Boffi konstruiert und baut seine Produkte ausschließlich in Italien. Das Unternehmen ist nach ISO 9001:2008 zertifiziert. Die Umweltzertifizierung ISO 14001:2004 ist eine Garantie für die gewissenhafte Überwachung möglicher Umweltauswirkungen der Fertigungsprozesse. Die internen Qualitäts- und Umweltrichtlinien sehen Maßnahmen zur kontinuierlichen Verbesserung vor, die sämtliche Bereiche des Unternehmens betreffen. Für alle Boffi Produkte gilt eine dreijährige Gewährleistung ab dem Ausstellungsdatum der Garantiebescheinigung.

Boffi, empresa con certificación ISO 9001:2008, diseña y realiza sus productos exclusivamente en Italia. La certificación ISO 14001:2004 también garantiza el control sobre el impacto ambiental derivado de los procesos de producción. Las políticas de calidad y medio ambiente incluyen acciones de mejora continua que involucran toda la organización. Los productos Boffi están garantizados por un periodo de tres años a partir de la fecha emisión del certificado de garantía.

**Boffi Spa** Via Oberdan, 70  
20823 Lentate Sul Seveso, [MB] Italia  
Tel. +39.0362.5341  
boffimarket@boffi.com - www.boffi.com



ADI  
Compasso d'oro  
Career Award  
1995

ADI  
Compasso  
d'oro  
Eclipse 2018



Impresa

**ALTAGAMMA**

Member

Project/ **GRAPH.X**  
Photo/ **DUILIO BITETTO, ALESSANDRO GIOMO,**  
**TOMMASO SARTORI,**  
Retouching/Pre Press/ **A. DE PEDRINI**